

## PSF 6.0

### Product Short Form



**WAGO Rail-Mounted Terminal Block Systems**  
Full Line Catalog, Volume 1 – Edition 2019/2020

1

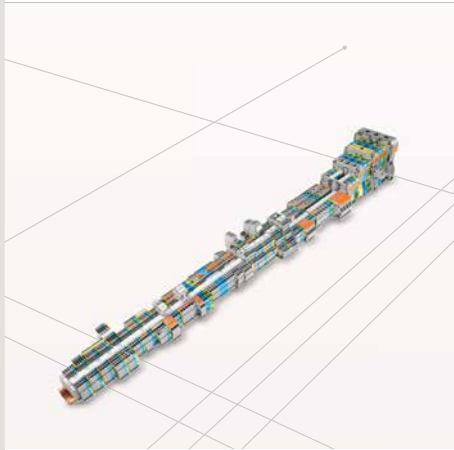

**WAGO PCB Terminal Blocks and WAGO Connectors**  
Full Line Catalog, Volume 2 – Edition 2019/2020

2

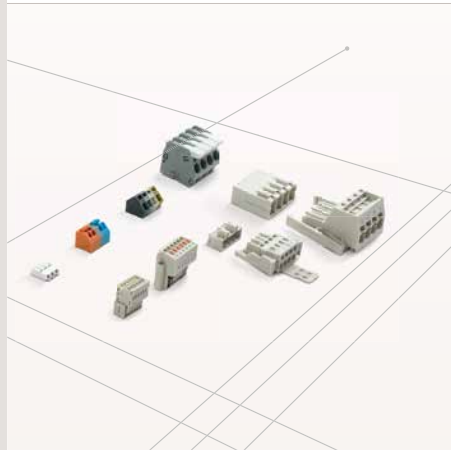

**Automation Technology**  
Full Line Catalog, Volume 3 – Edition 2019/2020

3

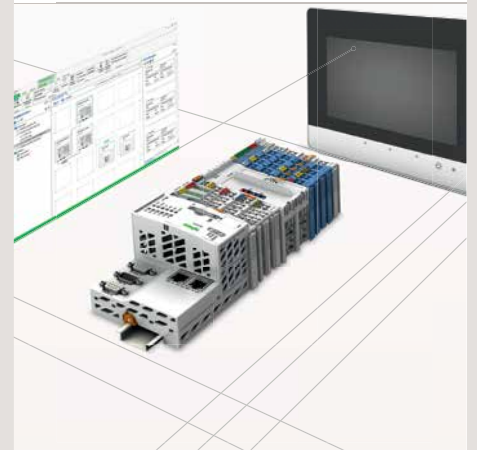

**WAGO Electronic Interface**  
Full Line Catalog, Volume 4 – Edition 2019/2020

4

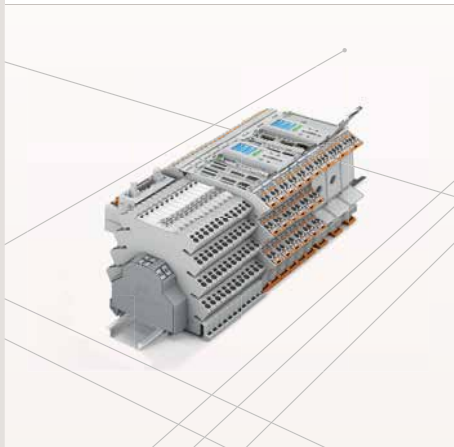

**WAGO Pluggable Connection System WINSTA®**  
Full Line Catalog, Volume 5 – Edition 2019/2020

5



**WAGO Marking**  
Full Line Catalog, Volume 6 – Edition 2019/2020

6



# WAGO Full Line Catalogs



## Volume 1, WAGO Rail-Mount Terminal Block Systems

- Rail-Mount Terminal Blocks
- Rail-Mount Terminal Blocks with Pluggable Connector (X-COM®-SYSTEM)
- Patchboard Systems
- Terminal Strips
- PUSH WIRE® Connectors for Junction Boxes
- Lighting Connectors
- Shield Connecting System



## Volume 2, WAGO PCB Terminal Blocks and WAGO Connectors

- PCB Terminal Blocks
- THR/SMD PCB Terminal Blocks
- *MULTI CONNECTION SYSTEM (MCS)*
- Pluggable PCB Terminal Blocks
- Feedthrough Terminal Blocks
- Specialty Connectors
- Empty Housings



## Volume 3, Automation Technology

- Solutions & Software
- Operating & Monitoring
- Controllers
- Modular I/O-SYSTEM, IP20
- Industrial Switches
- Radio Technology
- IP67 Sensor/Actuator Boxes, IP67 Cables and Connectors



## Volume 4, WAGO Interface Electronic

- Relay and Optocoupler Modules
- Signal Conditioners and Isolation Amplifiers
- Current and Energy Measurement Technology
- Power Supplies
- Interface Modules and System Wiring
- Overvoltage Protection
- Empty Housings



## Volume 5, WAGO Pluggable Connection System WINSTA®

- Pluggable Connectors
- Snap-In Device Connectors
- Pluggable PCB Connectors
- Distribution Connectors
- Cable Assemblies
- Flat Cable Systems
- Distribution Boxes



## Volume 6, WAGO Marking

- Printer
- Software
- Terminal Block Marking
- Cable and Conductor Marking
- Device Marking
- Marker Carriers

## WAGO Product Short Form 6.0

		Page	
	WAGO Rail-Mount Terminal Blocks	18	1
	WAGO Installation Connectors	104	2
	WAGO Pluggable Connectors	124	3
	WAGO PCB Terminal Blocks	144	4
	WAGO WINSTA® Pluggable Connection System	154	5
	WAGO Automation Technology	162	6
	WAGO Power Supplies	218	7
	WAGO Signal Conditioners, Relays and Overvoltage Protection	228	8
	WAGO Current and Energy Measurement Technology	256	9
	WAGO Accessories for Interface Electronics	262	10
	WAGO Accessories and WAGO Tools	270	11
	Technical Section	282	12
	Indexes and Addresses	288	13

## More Than 50 Years of Innovation



1951

The First WAGO Spring Clamp

Since its establishment in 1951, WAGO has pioneered multiple innovative connection systems for both electrical and electronic engineering applications. The idea for a screwless termination system was born in 1951; the first terminal blocks with spring clamp termination technology were presented at the Hannover Messe trade fair the same year.



1974

WAGO Connector for Junction Boxes

Precisely designed and manufactured, spring clamp terminal blocks not only guarantee a faster and easier connection, but also offer greater safety because the contact quality is largely independent of operator skill.



1977

Rail-mount terminal blocks with CAGE CLAMP® connection

Today, WAGO is meeting virtually all of the industry's needs as both the leader in spring pressure connection technology and a pioneer in automation technology. In 1977, the success story of the CAGE CLAMP® began with "vibration-proof, fast, maintenance-free connections." Safe operation for countless devices, systems and installation depends on the absolute reliability of our products.



1985

Pluggable electronic modules on rail-mount terminal blocks

1995

I/O SYSTEM, 750/753, modular I/O-System, IP20



1998

POWER CAGE CLAMP



2003

TOPJOB® S Rail-Mount Terminal Blocks with Push-in CAGE CLAMP®

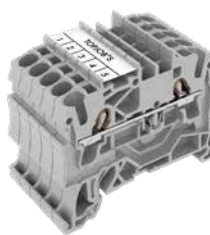

2006

Signal Conditioners and Pluggable Relay Modules



1997

X-COM®-SYSTEM



2001

WINSTA® – the Pluggable Connection System

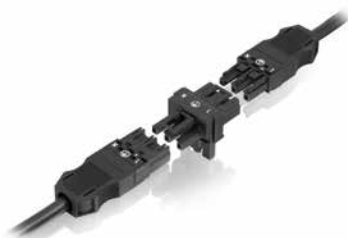

2004

Splicing Connectors for All Conductor Types



2008

TO-PASS® – Scalable Telecontrol Technology



## Recognized and Approved Worldwide



2010

Touch and Control Panels

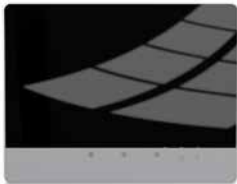

2014

Splicing connectors, universal, 221 Series



2015

PFC200 – Controller



2019

Pro 2 Power Supplies



2020

I/O System Advanced



2010

Connectors for Junction Boxes, 2273 Series



2014

Shield Clamping Saddle



2015

e!COCKPIT – Integrated Engineering



2018

TOPJOB® S Rail-Mount Terminal Blocks with Levers/ Push-Buttons



2020

I/O System Field



## From Pioneer to Leader



WAGO Minden, Germany – Global Headquarters

When the first screwless terminal blocks debuted at the Hannover Messe trade fair in 1951, they represented a significant advance in manufacturing. At the time, manufacturing terminal blocks was not possible because the carbon steel available then did not meet the strict quality requirements.

Undeterred, WAGO was quite active in the years leading up to the 1977 debut of the first series of CAGE CLAMP®-equipped rail-mount terminal blocks of 0.08–16 mm<sup>2</sup> (28–6 AWG). With numerous developments – from the Suprafix banana plug product family, to the first range of rail-mount terminal blocks for conductors up to 16 mm<sup>2</sup> (6 AWG) – WAGO has firmly established itself as an innovator.

With this reputation and the need for “vibration-proof, fast, maintenance-free” connections, CAGE CLAMP® quickly outperformed all previous connection technologies to become a worldwide industrial standard.

Today, CAGE CLAMP® technology has several imitators, yet it remains unmatched. WAGO continues to set new standards with further developments, such as the CAGE CLAMP® Compact (1996) for ultra-compact applications and the WAGO POWER CAGE CLAMP (1998) for rated cross-sections up to 185 mm<sup>2</sup> (350 kcmil). The figures speak for themselves: More than 26 billion CAGE CLAMP® springs have been sold worldwide, and every day, millions of clamps are added to that number.

In 1951, WAGO was founded in Minden, Germany. Today the WAGO Group consists of 32 companies with more than 8,500 employees, worldwide operations and global sales of 954 million euros (2019).

The first factory was located in Minden, Germany, which is also our global headquarters. As part of WAGO’s international expansion, additional factories have been built: 1977 in Domdidier (Switzerland), 1979 in Milwaukee (USA), 1995 in Sondershausen (Germany) and Delhi (India), as well as 1997 in Tianjin (China) and Wroclaw (Poland).

Products manufactured locally for domestic and foreign markets form the starting point for localized distribution networks that cover WAGO’s complete product portfolio. This system allows all WAGO subsidiaries and sales offices to develop and deliver custom-designed products that comply with local regulations and meet local demand. More than half of WAGO’s global staff of 8,500 is employed outside of Germany.

# WAGO Worldwide



WAGO Minden



WAGO Papinghausen



WAGO Sondershausen, Germany



WAGO Switzerland



WAGO France



WAGO Poland



WAGO USA



WAGO China



WAGO India



WAGO Japan

# WAGO Product Range: Connection Technology

X-COM®-SYSTEM  
X-COM®S-SYSTEM

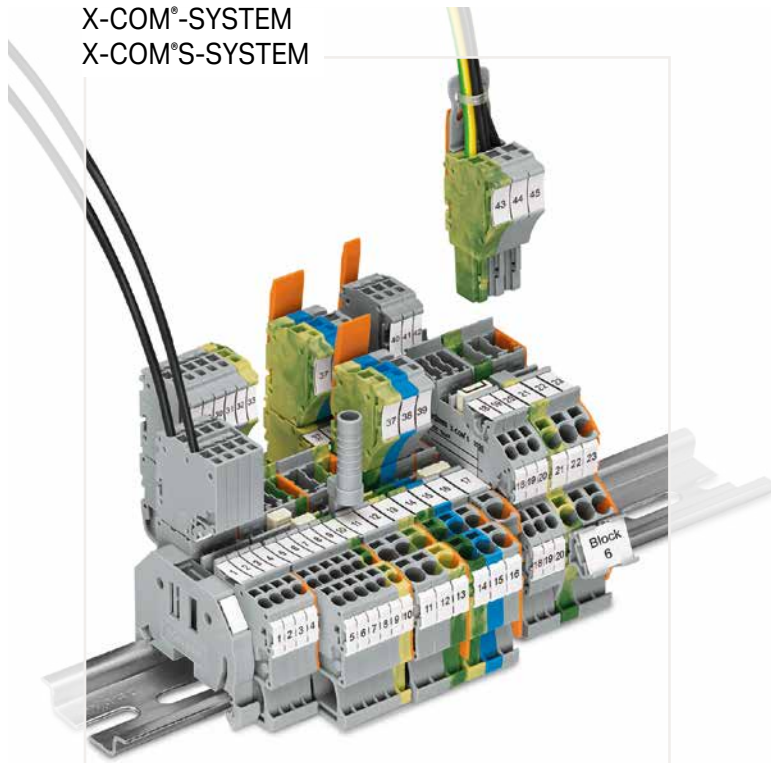

See also: Full Line Catalog, volume 1

## Installation Terminal Blocks



See also: Full Line Catalog, volume 1

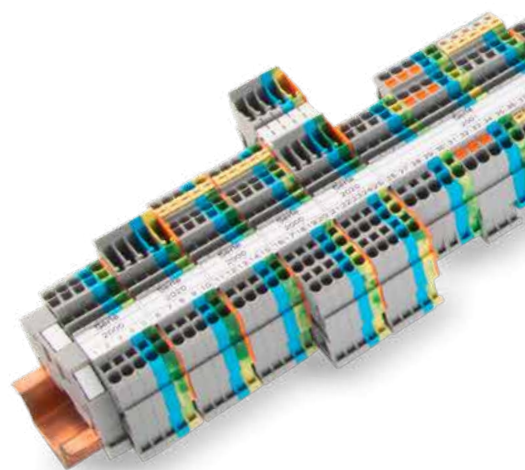

## Modular Terminal Blocks

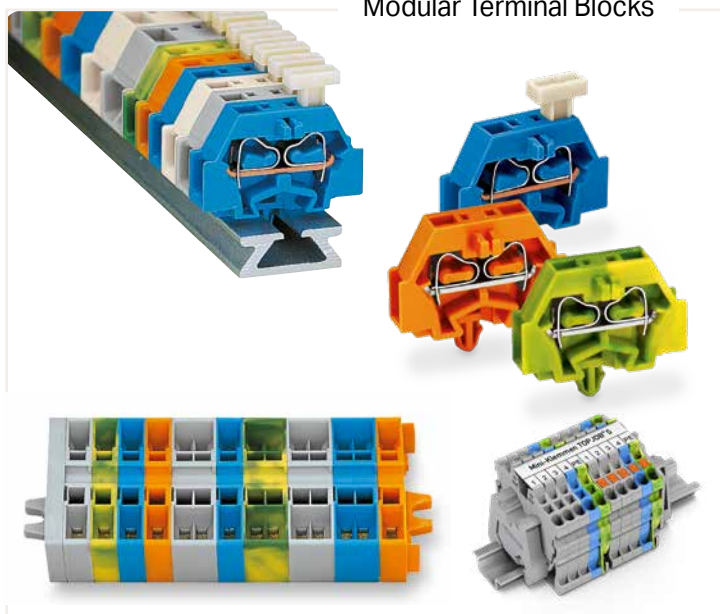

See also: Full Line Catalog, volume 1

## PCB Terminal Blocks



See also: Full Line Catalog, volume 2



### Rail-Mount Terminal Block Systems

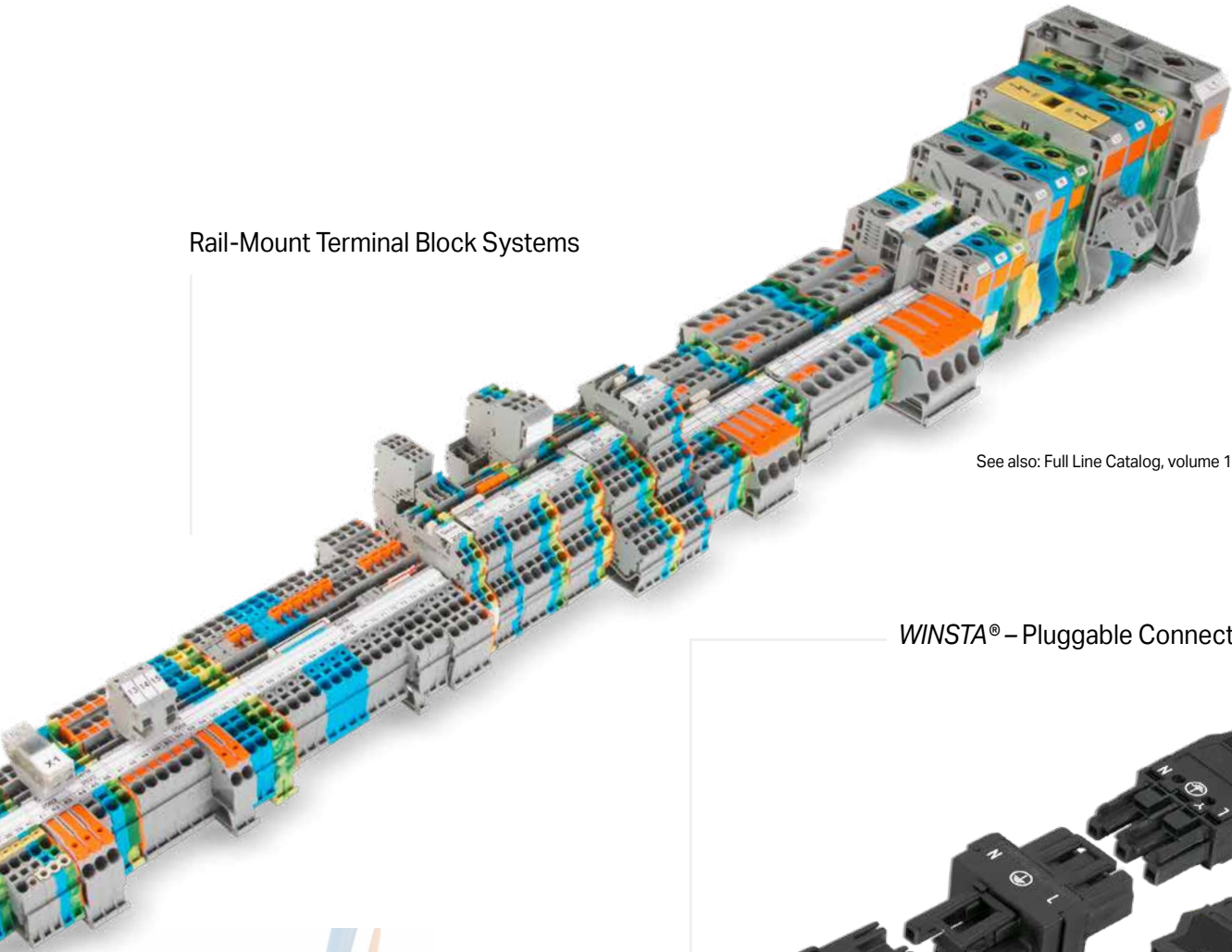

See also: Full Line Catalog, volume 1

### WINSTA® – Pluggable Connection System



See also: Full Line Catalog, volume 5

### picoMAX®

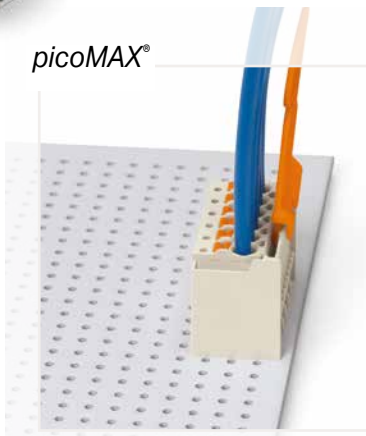

See also: *picoMAX*® catalog

### Patchboard Systems

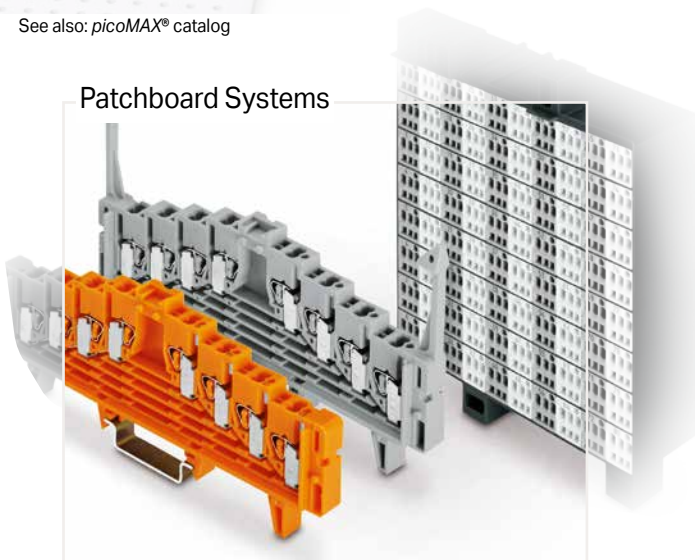

See also: Full Line Catalog, volume 1

### Connectors

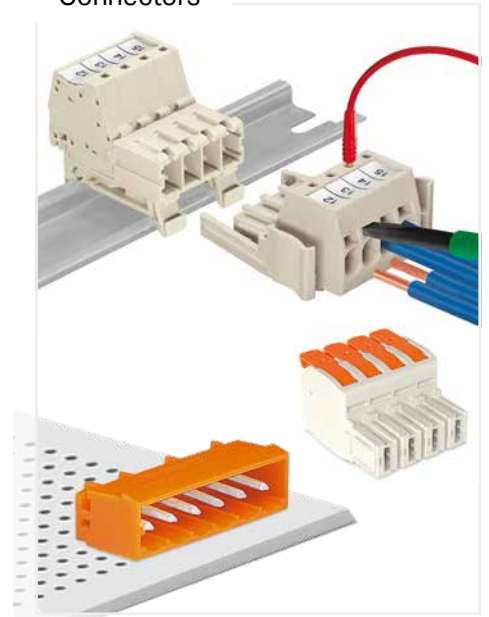

See also: Full Line Catalog, volume 2

# WAGO Product Range: Automation

## Touch Panels and Displays



See also: Full Line Catalog, volume 3

## Controllers



See also: Full Line Catalog, volume 3

## e!COCKPIT

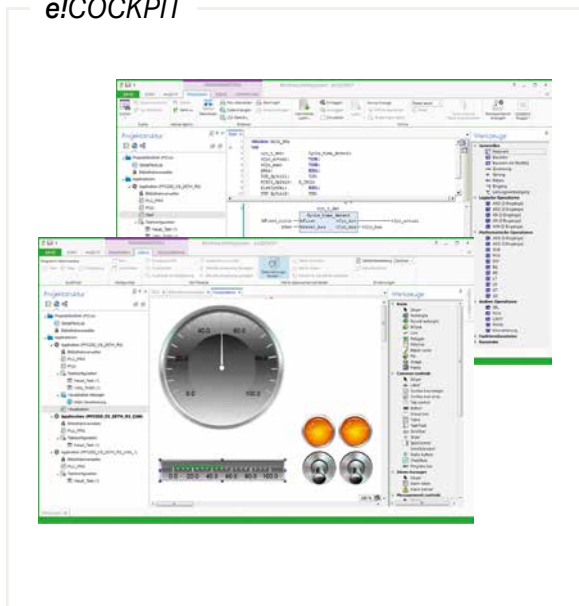

See also: Full Line Catalog, volume 3

## Power Supplies and System Devices



See also: Full Line Catalog, volume 4

## WAGO I/O System



See also: Full Line Catalog, volume 3

### Software and Apps



See also: Full Line Catalogs, volumes 3/4

### Overvoltage Protection and Specialty Electronics

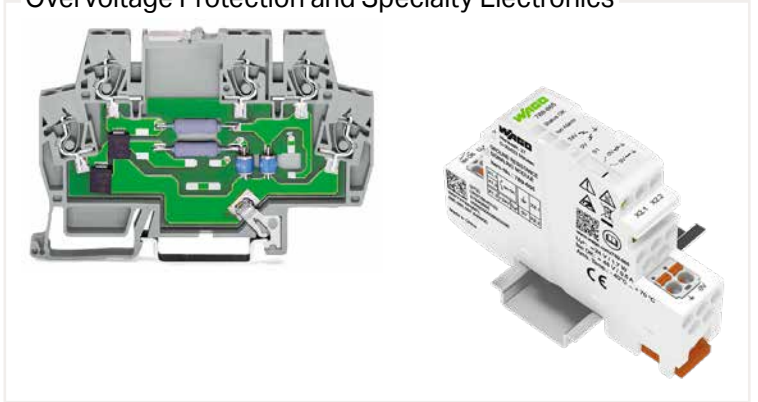

See also: Full Line Catalog, volume 4

### Signal Conditioners



See also: Full Line Catalog, volume 4

### Interface Modules

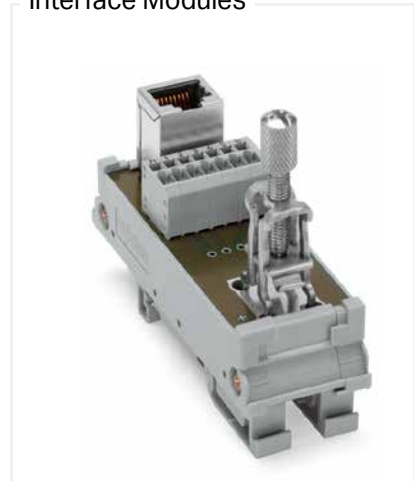

See also: Full Line Catalog, volume 4

### Relay Modules and Relay Sockets

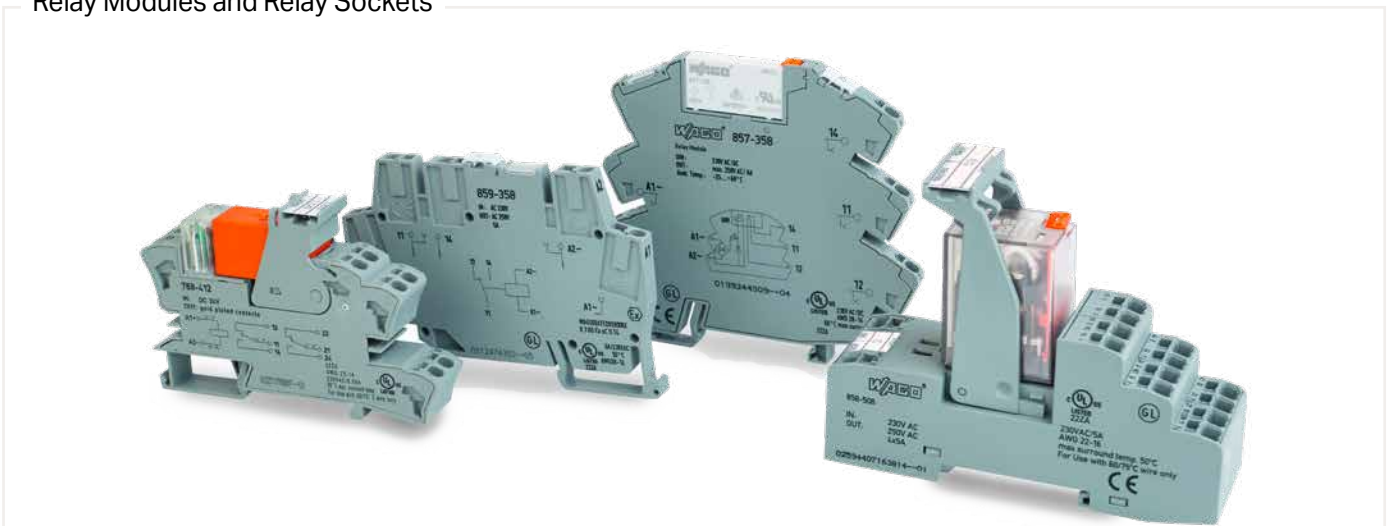

See also: Full Line Catalog, volume 4

## Operating WAGO Connection Technologies

Please follow the applicable product-specific termination instructions.

### PUSH-IN CAGE CLAMP®



Push-in CAGE CLAMP® terminates the following copper conductors:  
solid



stranded



fine-stranded,  
also with tinned  
single strands



fine-stranded,  
tip-bonded



fine-stranded,  
with ferrule  
(gastight crimped)



fine-stranded,  
with pin terminal  
(gastight crimped)

The universal connection with an additional advantage:

Push-in connection

Terminate solid and stranded (Class B 7 strands or less), as well as ferruled conductors, by simply pushing them in – no tools required.

Termination for all conductor types:

- Open clamping unit.
- Insert the conductor.
- Release clamp – done!

### CAGE CLAMP®

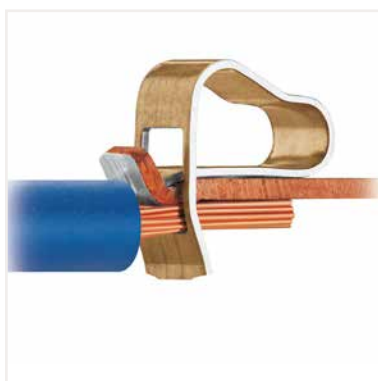
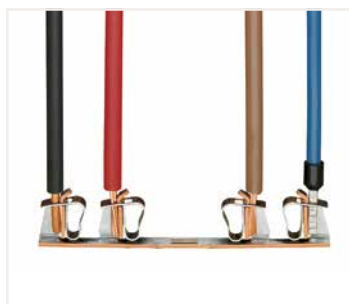

CAGE CLAMP® terminates the following copper conductors:  
solid



stranded



fine-stranded,  
also with tinned  
single strands



fine-stranded,  
tip-bonded



fine-stranded,  
with ferrule  
(gastight crimped)



fine-stranded,  
with pin terminal  
(gastight crimped)

The universal connection for solid, stranded and fine-stranded conductors

Termination:

- Open clamping unit.
- Insert the conductor.
- Release clamp – done!

## Operating WAGO Connection Technologies

Please follow the applicable product-specific termination instructions.

### POWER CAGE CLAMP®



POWER CAGE CLAMP terminates the following copper conductors:  
solid



stranded



fine-stranded,  
also with tinned  
single strands



fine-stranded,  
with ferrule  
(gastight crimped)

The universal connection for conductors larger than 35 mm<sup>2</sup> (2 AWG)

Termination:

- Open clamp by turning a T-wrench counter-clockwise.
- Press the integrated latch to open clamping unit for hands-free wiring.
- Insert the conductor.
- A small counter-clockwise rotation closes the clamp, securing conductor.

### PUSH WIRE®



PUSH WIRE® terminates the following copper conductors:  
solid

PUSH WIRE® connection for solid and stranded conductors (depending on the model used)

Termination:

Tool-free, twist-free terminations for solid and rigid stranded conductors – simply push into the unit.

# Benefits of WAGO Connection Technology

## Simple, Easy-to-Use Design

Front-entry wiring:

### PUSH-IN CAGE CLAMP®

Push-in CAGE CLAMP® connection

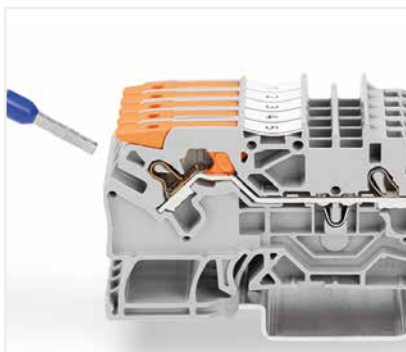

Push-in CAGE CLAMP® terminates both solid and ferruled conductors by simply pushing them in.

Side-entry wiring:

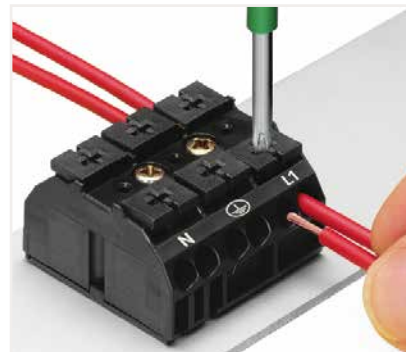

### CAGE CLAMP®

CAGE CLAMP® connection

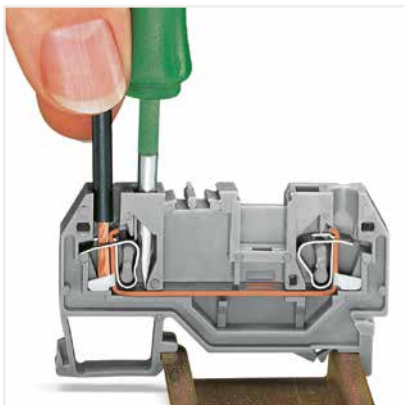

CAGE CLAMP® connection

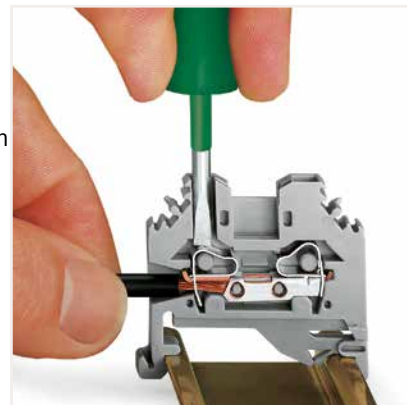

## Benefits of WAGO Technology

### One Conductor per Clamping Unit

Several of VDE directives mandate or recommend that only one conductor should or must be connected per clamping unit (e.g., DIN VDE 0611, Part 4, 02.91, Section 3.1.9). WAGO complies with this safety requirement, as expressed in the corresponding directives.

The technical and economic benefits of this for users include the following:

- Each conductor is clamped independently.
- Any conductor size combination per potential can be safely connected.
- Where re-wiring is required, only the conductor to be changed is removed from the clamping point – all other conductors remain safely clamped.
- The arrangement of more than two clamping units on one current bar permits potential multiplication, without jumpers or additional terminal blocks.

CAGE CLAMP® and Push-in CAGE CLAMP® terminate all copper conductors from 28 to 2 AWG (0.08–35mm<sup>2</sup>) (350 kcmil/185 mm<sup>2</sup>), or from 22 to 4 AWG (0.25–25 mm<sup>2</sup>). Splice protection is not required, but is possible.

The conductor is pressed against the current bar in the **predefined contact area**, without damage. The clamping force adjusts automatically to the conductor size. The clamp dynamically compensates for changes/movement of the conductor to eliminate the risk of a loose connection.

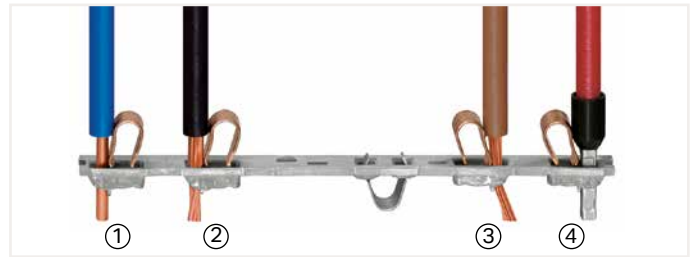

Push-in CAGE CLAMP® terminates one conductor per clamping unit.

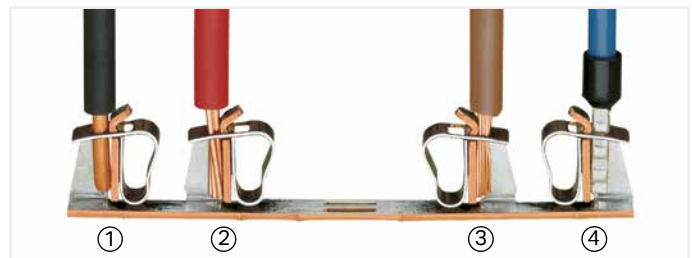

CAGE CLAMP® terminates one conductor per clamping unit

- ① Solid
- ② Stranded
- ③ Fine-stranded
- ④ Fine-stranded with ferrule (gastight crimp)

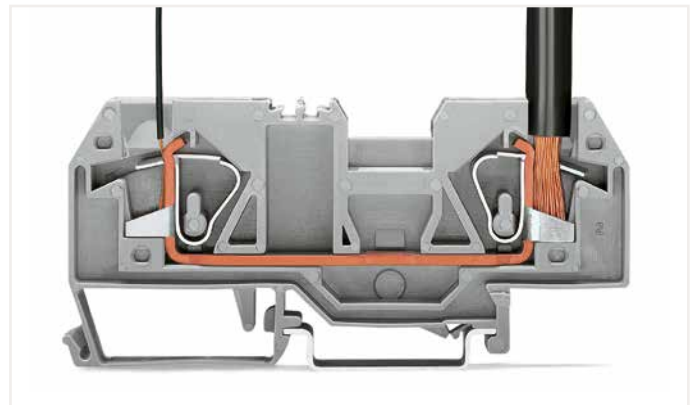

An unlikely connection demonstrates this capability: 24 AWG (0.2 mm<sup>2</sup>) conductor (left) and 6 AWG (16 mm<sup>2</sup>) conductor (right) in a 6 AWG (16 mm<sup>2</sup>) terminal block.

## Benefits of WAGO Technology

### Vibration- and Shock-Proof – Maintenance-Free

The **vibration-proof properties** of CAGE CLAMP® connections have been tested and successfully validated in a vibration test per IEC/EN 60068-2-6. This test involves continuous passes through a frequency band up to 2,000 Hz, at different accelerations up to 20g and different amplitudes up to 20 mm, on three axes. Additionally, international authorities have placed extremely demanding requirements on electrical installations. Railway authorities have tested electrical installations in rolling stock (IEC/EN 61373); multiple marine agencies (e.g., GL, LR and DNV) have declared that CAGE CLAMP® meets their high approval standards. It passed these tests as well.

In the **Impact Test** (IEC/EN 60068-2-27) for railway applications (IEC/EN 61373), test specimens are exposed to instant shock stresses, instead of permanent vibrations. It easily withstood stresses up to 100g on the x-, y-, and z-axis.

**Maintenance-free operation** results from excellent long-term stability of the electrical and mechanical properties of the clamping connection – or more precisely, the clamping unit. The voltage drop test evaluates clamping unit quality under stress such as vibration, temperature change and industrial climate, in order to verify that the contact point is gas-tight. The long-term reliability of CAGE CLAMP® technology has been demonstrated through both laboratory testing by international approval agencies and by worldwide applications.

The resulting maintenance-free operation reduces service costs, leading to greater system uptime and reliability.

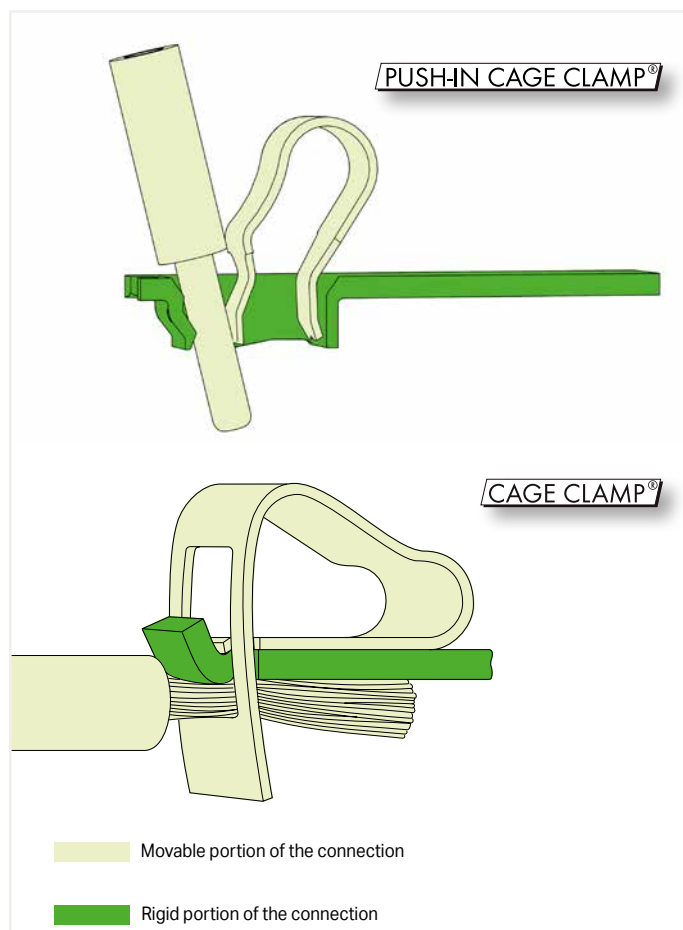

WAGO-I/O-SYSTEM vibration test





## Benefits of WAGO Technology

### Gastight Clamping Units – Measurable Contact Quality

For climatic tests, climatic chambers simulate standard atmospheres that could impact the long-term consistency of clamping units. All WAGO products meet requirements for the following climatic tests:

- Temperature Cycling Test per IEC/EN 60947-7-1, IEC/EN 60998-2-2
- Industrial Atmospheres per EN ISO 6988, IEC/EN 60068-2-42, IEC/EN 60068-2-60
- Salt Spray Test per IEC/EN 60068-2-11; GL, LR, DNV (Marine Applications)
- Quick Change of Temperature per IEC/EN 60068-2-14
- Damp Heat, Cyclic (12 + 12 Hour Cycle) per IEC/EN 60068-2-30, GL, LR, DNV (Marine Applications)

The long-term stability of the low contact resistance of both CAGE CLAMP® and Push-in CAGE CLAMP® results from **gas-tight** clamping units. The spring clamp (acid- and saltwater-proof CrNi spring steel) presses the connected conductor against the current bar (electrolyte copper with lead-free, pure tin coating) within a defined contact zone. The conductor is embedded into the soft tin layer with high contact pressure, securing it against corrosive infiltration.

The contact pressure exerted by CAGE CLAMP® connections is similar to screw connections.



Contact pressure

$$P \left[ \frac{\text{N}}{\text{mm}^2} \right] = \frac{\text{Force } F [\text{N}]}{\text{Area } A [\text{mm}^2]}$$

Numerical example

$$\left[ \frac{700 \text{ N}}{4 \text{ mm}^2} \right] = \left[ \frac{70 \text{ N}}{0,4 \text{ mm}^2} \right]$$

Screw                      Spring

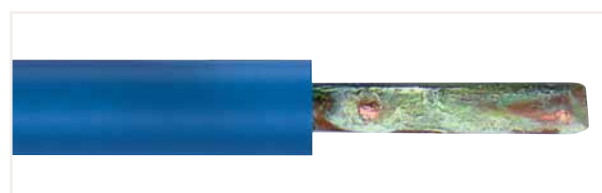

To best evaluate the quality of a clamping point, WAGO uses the following test procedures:

The **voltage drop test** evaluates clamping unit quality under stress such as vibrations, temperature change and industrial climate.

The **temperature-rise test** examines the clamping unit – including the surrounding insulation – at rated current, overcurrent and short-circuit current levels.

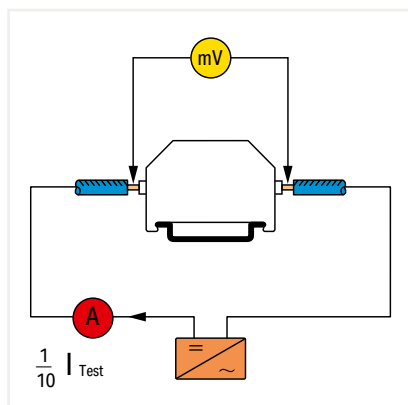

Test arrangement: "Voltage Drop Test"

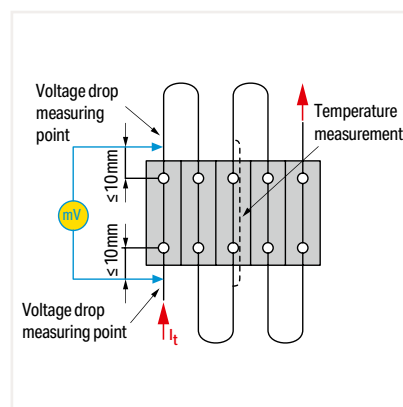

Test arrangement: "Temperature-Rise Test"

## Benefits of WAGO Technology Electromagnetic Compatibility (EMC)

State-of-the-art testing equipment in our laboratory enables us to conduct the most stringent electrical, mechanical and climatic tests. In addition, our electromagnetic compatibility chamber is dedicated to testing our automation components for compliance with electromagnetic safety regulations.

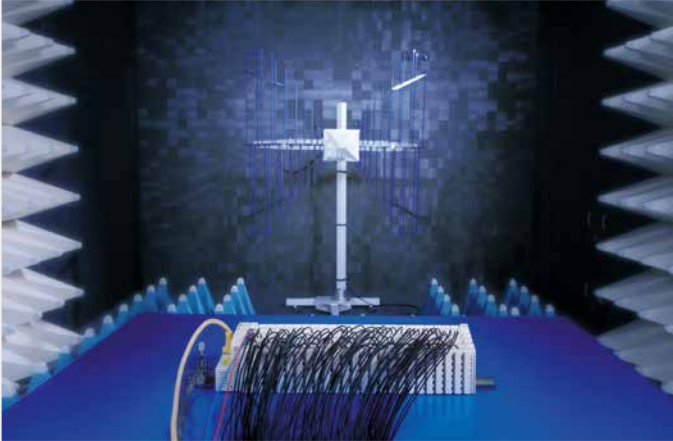

To isolate and eliminate any weak points during development in our electromagnetic compatibility laboratory, we can use bursts of up to 3 kV.

All of our automation components have to meet WAGO's requirements, which are stricter than those defined in CE specifications and the requirements as specified by the international shipping classification organizations.

### Time Saved

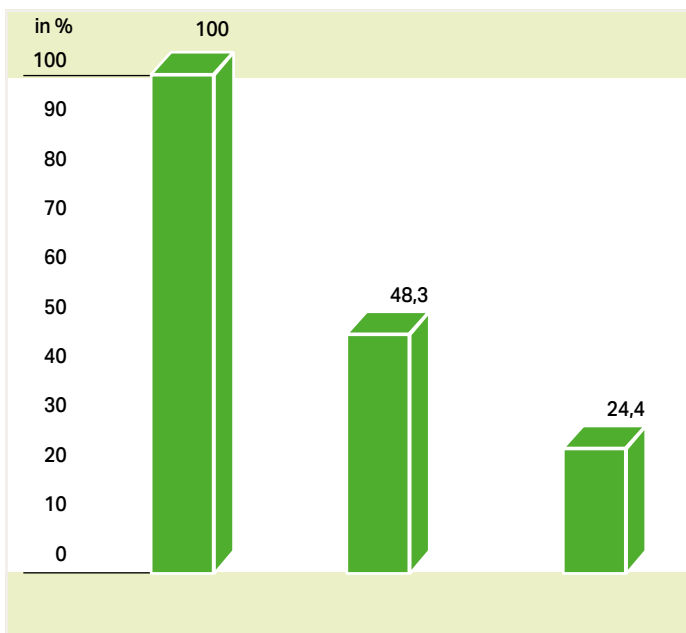

CAGE CLAMP® technology significantly reduces wiring times, which helps minimize labor costs.

Additional savings are provided via **faster commissioning** and the **elimination of service costs** due to maintenance-free connections.

Savings go further by **reducing both material and labor costs** by eliminating the need to crimp ferrules or use pin terminals prior to termination. Front-entry terminal blocks are specified for top-tier designs because they minimize both installation time and effort.

### Comparison of Average Manual Wiring Times in Percentages (per MTM)

Screw connection

CAGE CLAMP® and Push-in CAGE CLAMP® terminate solid conductors without ferrules and fine-stranded conductors with ferrules

Push-in CAGE CLAMP® connection, front-entry wiring, direct push-in connection of solid conductors and fine-stranded conductors with ferrules

# WAGO Rail-Mount Terminal Blocks TOPJOB® S; With Levers and Push-in CAGE CLAMP®; With Push-Buttons and Push-in CAGE CLAMP – 2102 to 2216 Series

## Description and Installation

1

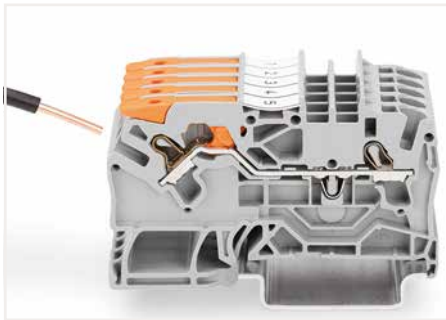

Insert solid conductors via push-in termination.

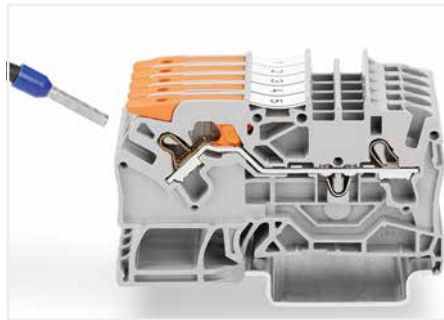

Insert fine-stranded conductors with ferrules via push-in termination.

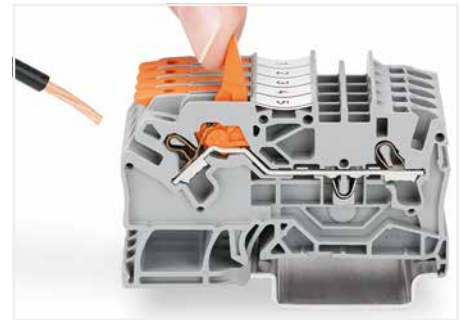

Pull the lever up until it stops, then connect the fine-stranded conductor.



Push the lever back down – done!

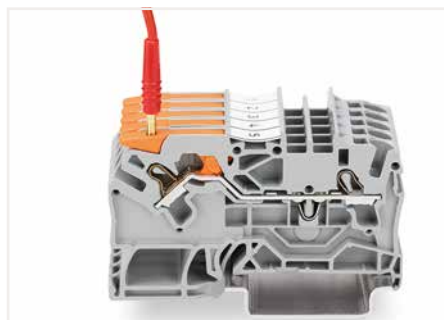

Testing with a 2 mm Ø test plug (max. 42 V).



Insert solid and ferruled conductors via push-in termination.



Insert fine-stranded conductors via operating tool.



Remove all conductors via operating tool.



Testing with a 2 mm Ø test plug (max. 42 V).



Insert a push-in type jumper bar and push down until it hits the backstop.



Commoning with step-down jumpers.



Snapping a marking strip into the marker slot.

# WAGO Rail-Mount Terminal Blocks TOPJOB® S; With Push-in CAGE CLAMP®

## 2000 to 2016 Series

### Description and Installation

1

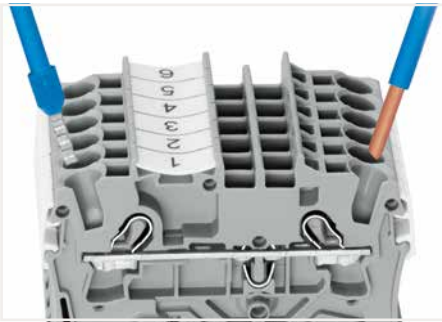

Insert solid and ferruled conductors via push-in termination.

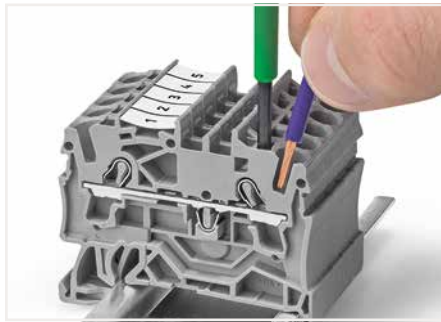

Insert fine-stranded conductors via operating tool.

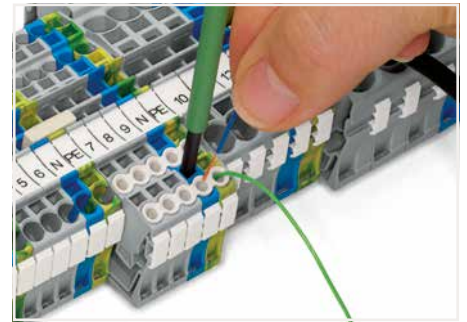

Inserting a conductor into the insulation stop.

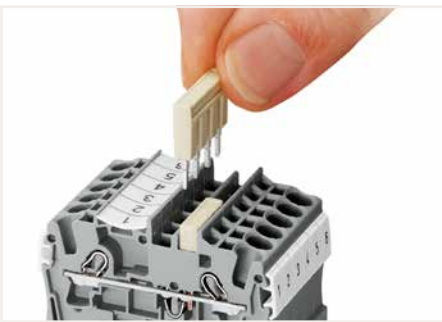

Insert a push-in type jumper bar and push down until it hits the backstop.



Custom jumpers are created by breaking and removing jumper contacts (2000, 2001, 2002, 2004 Series).

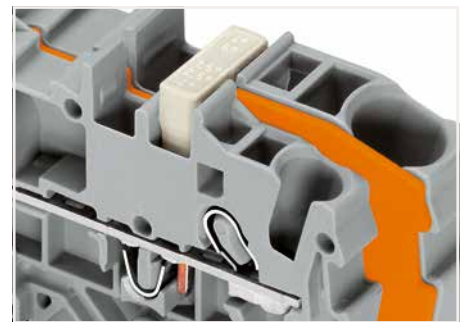

Commoning with step-down jumpers.



Test plug adapter (2009-174, CAT I) for 4 mm Ø plugs – compatible with 2000 to 2016 Series

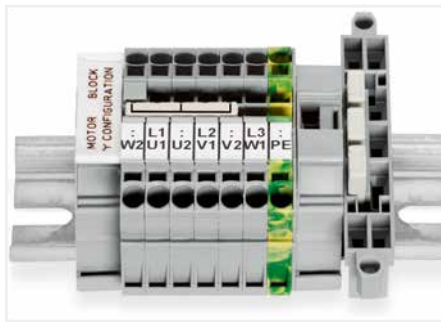

This star point jumper has been specially developed to create a "star point" and is used on motor terminal boards equipped with TOPJOB® S Rail-Mount Terminal Blocks.

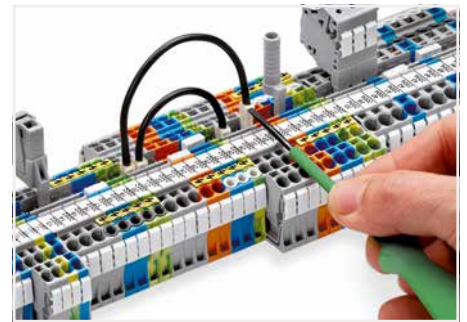

Push down the wire jumper until fully inserted. Lift the jumper with an operating tool for rewiring.



L-type test plug modules fitted in a triple-deck terminal block

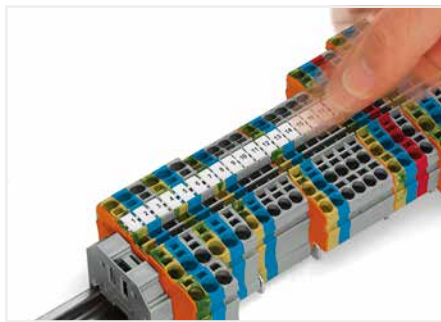

Snapping a marking strip into the marker slot.

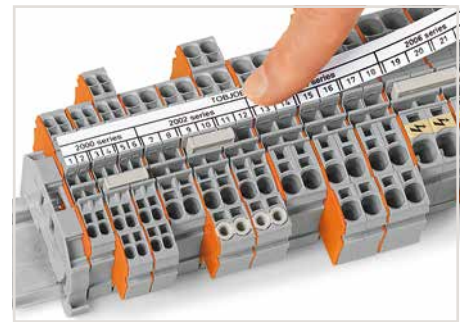

Snapping a marking strip into a marker slot.

# WAGO Through/Ground Terminal Block TOPJOB® S – 2000/2200 Series

## 1 (1.5) mm<sup>2</sup>

1

Image	Description	Color	With Push-Button Item No.	Without Push-Button Item No.	PU	Dimensions (W x H x D)	Electrical Data
<b>2-conductor through terminal block</b>							
	2-conductor through terminal block	gray ⑤	2200-1201	2000-1201 ②	100	3,5 x 32,9 x 48,5 mm / 0.14 x 1.3 x 1.91 inch	800 V/8 kV/3 ①; I <sub>n</sub> 13,5 A (18 A); 600 V, 10 A ④; 600 V, 10 A ⑥
	2-conductor through terminal block	blue ⑤	2200-1204 ③	2000-1204 ②③	100		
	2-conductor through terminal block	orange ⑤		2000-1202 ②	100		
	2-conductor through terminal block	red ⑤		2000-1203 ②	100		
	2-conductor through terminal block	black ⑤		2000-1205 ②	100		
	2-conductor through terminal block	yellow ⑤		2000-1206 ②	100		
	2-conductor ground terminal block	green-yellow ⑤	2200-1207	2000-1207 ②	100		
	End and intermediate plate; 0,7 mm thick	orange	2000-1292	2000-1292	25	0,7 x 33 x 48,5 mm / 0.03 x 1.3 x 1.91 inch	
	End and intermediate plate; 0,7 mm thick	gray	2000-1291	2000-1291	25		
	Separator plate Ex e/Ex i; 3 mm thick; 90 mm	orange	209-190	209-190	25	3 x 52 x 90/120 mm /	
	Separator plate Ex e/Ex i; 3 mm thick; 120 mm	orange	209-191	209-191	25	0.12 x 2.05 x 3.54/4.72 inch	
<b>3-conductor through terminal block</b>							
	3-conductor through terminal block	gray ⑤	2200-1301	2000-1301 ②	100	3,5 x 32,9 x 58,2 mm / 0.138 x 1.3 x 2.29 inch	800 V/8 kV/3 ①; I <sub>n</sub> 13,5 A (18 A); 600 V, 10 A ④; 600 V, 10 A ⑥
	3-conductor through terminal block	blue ⑤	2200-1304 ③	2000-1304 ②③	100		
	3-conductor through terminal block	orange ⑤		2000-1302 ②	100		
	3-conductor through terminal block	red ⑤		2000-1303 ②	100		
	3-conductor through terminal block	black ⑤		2000-1305 ②	100		
	3-conductor through terminal block	yellow ⑤		2000-1306 ②	100		
	3-conductor ground terminal block	green-yellow ⑤	2200-1307	2000-1307 ②	100		
	End and intermediate plate; 0,7 mm thick	orange	2000-1392	2000-1392	25	0,7 x 33 x 58,2 mm / 0.03 x 1.3 x 2.29 inch	
	End and intermediate plate; 0,7 mm thick	gray	2000-1391	2000-1391	25		
	Separator plate Ex e/Ex i; 3 mm thick; 120 mm	orange	209-191	209-191	25	3 x 52 x 120 mm / 0.12 x 2.05 x 4.72 inch	
<b>4-conductor through terminal block</b>							
	4-conductor through terminal block	gray ⑤	2200-1401	2000-1401 ②	100	3,5 x 32,9 x 67,9 mm / 0.14 x 1.3 x 2.67 inch	800 V/8 kV/3 ①; I <sub>n</sub> 13,5 A (18 A); 600 V, 10 A ④; 600 V, 10 A ⑥
	4-conductor through terminal block	blue ⑤	2200-1404 ③	2000-1404 ②③	100		
	4-conductor through terminal block	orange ⑤		2000-1402 ②	100		
	4-conductor through terminal block	red ⑤		2000-1403 ②	100		
	4-conductor through terminal block	black ⑤		2000-1405 ②	100		
	4-conductor through terminal block	yellow ⑤		2000-1406 ②	100		
	4-conductor ground terminal block	green-yellow ⑤	2200-1407	2000-1407 ②	100		
	End and intermediate plate; 0,7 mm thick	orange	2000-1492	2000-1492	25	0,7 x 33 x 67,9 mm / 0.03 x 1.3 x 2.67 inch	
	End and intermediate plate; 0,7 mm thick	gray	2000-1491	2000-1491	25		
	Separator plate Ex e/Ex i; 3 mm thick; 120 mm	orange	209-191	209-191	25	3 x 52 x 120 mm / 0.12 x 2.05 x 4.72 inch	
<b>Double potential terminal block</b>							
	Double potential terminal block; both potentials can be commoned	gray		2000-2141	100	3,5 x 32,9 x 85,9 mm / 0.14 x 1.3 x 3.38 inch	800 V/8 kV/3 ①; I <sub>n</sub> 13,5 A (18 A); 600 V, 10 A ④; 600 V, 10 A ⑥
	End and intermediate plate; 0,7 mm thick	orange	2000-2196	2000-2196	25	0,7 x 33 x 85,9 mm /	
	End and intermediate plate; 0,7 mm thick	gray	2000-2195	2000-2195	25	0.03 x 1.3 x 3.38 inch	

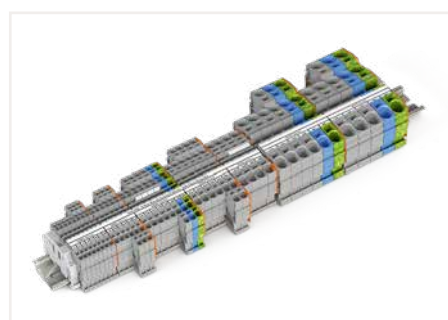

Conductor range: 0.14 ... 1.5 mm<sup>2</sup> "s+f-st"; Push-in termination: 0.5 ... 1.5 mm<sup>2</sup> "s" and 0.5 ... 0.75 mm<sup>2</sup> "insulated ferrules; 12 mm"; 24 ... 16 AWG; Strip length: 9 ... 11 mm / 0.35 ... 0.43 inch  
Accessories: see pages 36 ... 38.

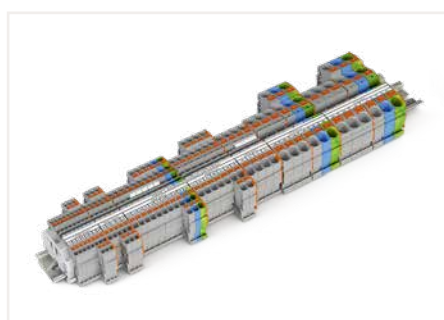









① 800 V = rated voltage;  
8 kV = rated impulse voltage;  
3 = pollution degree  
Marking: WMB/WMB Inline/Marking strips



② Suitable for Ex e II applications; 550 V; 13 A  
③ Suitable for Ex i applications  
Suitable operating tool: see page 39

# WAGO Through/Ground/Shield Terminal Block TOPJOB® S – 2001/2201 Series

## 1.5 (2.5) mm<sup>2</sup>

Image	Description	Color	With Push-Button Item No.	Without Push-Button Item No.	PU	Dimensions (W x H x D)	Electrical Data
<b>2-conductor through terminal block</b>							
	2-conductor through terminal block	gray ⑤	2201-1201	2001-1201 ②	100	4,2 x 32,9 x 48,5 mm / 0.165 x 1.3 x 1.91 inch	800 V/8 kV/3 ①; I <sub>N</sub> 18 A (24 A); 600 V, 15 A ③; 600 V, 15 A ④
	2-conductor through terminal block	blue ⑤	2201-1204 ③	2001-1204 ②③	100		
	2-conductor through terminal block	orange ⑤		2001-1202 ②	100		
	2-conductor through terminal block	red ⑤		2001-1203 ②	100		
	2-conductor through terminal block	black ⑤		2001-1205 ②	100		
	2-conductor through terminal block	yellow ⑤		2001-1206 ②	100		
	2-conductor ground terminal block	green-yellow ⑤	2001-1207	2001-1207 ②	100		
	2-conductor shield terminal block	white		2001-1208	100		
	End and intermediate plate; 0.8 mm thick	orange	2002-1292	2002-1292	25	0,8 x 33 x 48,5 mm / 0.03 x 1.3 x 1.91 inch	
	End and intermediate plate; 0.8 mm thick	gray	2002-1291	2002-1291	25		
	Separator plate; oversized; 2 mm thick	orange	2002-1294	2002-1294	25	2 x 33,4 x 48,05 mm / 0.08 x 1.32 x 1.89 inch	
	Separator plate; oversized; 2 mm thick	gray	2002-1293	2002-1293	25		
	Separator plate Ex e/Ex i; 3 mm thick; 90 mm	orange	209-190	209-190	25	3 x 52 x 90/120 mm / 0.12 x 2.05 x 3.54/4.72 inch	
	Separator plate Ex e/Ex i; 3 mm thick; 120 mm	orange	209-191	209-191	25		
<b>3-conductor through terminal block</b>							
	3-conductor through terminal block	gray ⑤	2201-1301	2001-1301 ②	100	4,2 x 32,9 x 59,2 mm / 0.165 x 1.3 x 2.33 inch	800 V/8 kV/3 ①; I <sub>N</sub> 18 A (24 A); 600 V, 15 A ③; 600 V, 15 A ④
	3-conductor through terminal block	blue ⑤	2201-1304 ③	2001-1304 ②③	100		
	3-conductor through terminal block	orange ⑤		2001-1302 ②	100		
	3-conductor through terminal block	red ⑤		2001-1303 ②	100		
	3-conductor through terminal block	black ⑤		2001-1305 ②	100		
	3-conductor through terminal block	yellow ⑤		2001-1306 ②	100		
	3-conductor ground terminal block	green-yellow ⑤	2201-1307	2001-1307 ②	100		
	3-conductor shield terminal block	white		2001-1308	100		
	End and intermediate plate; 0.8 mm thick	orange	2002-1392	2002-1392	25	0,8 x 33 x 59,5 mm / 0.03 x 1.3 x 2.34 inch	
	End and intermediate plate; 0.8 mm thick	gray	2002-1391	2002-1391	25		
	Separator plate; oversized; 2 mm thick	orange	2002-1394	2002-1394	25	2 x 33,4 x 58,75 mm / 0.08 x 1.32 x 2.31 inch	
	Separator plate; oversized; 2 mm thick	gray	2002-1393	2002-1393	25		
	Separator plate Ex e/Ex i; 3 mm thick; 120 mm	orange	209-191	209-191	25	3 x 52 x 120 mm / 0.12 x 2.05 x 4.72 inch	
<b>4-conductor through terminal block</b>							
	4-conductor through terminal block	gray ⑤	2201-1401	2001-1401 ②	100	4,2 x 32,9 x 69,9 mm / 0.165 x 1.3 x 2.75 inch	800 V/8 kV/3 ①; I <sub>N</sub> 18 A (24 A); 600 V, 15 A ③; 600 V, 15 A ④
	4-conductor through terminal block	blue ⑤	2201-1404 ③	2001-1404 ②③	100		
	4-conductor through terminal block	orange ⑤		2001-1402 ②	100		
	4-conductor through terminal block	red ⑤		2001-1403 ②	100		
	4-conductor through terminal block	black ⑤		2001-1405 ②	100		
	4-conductor through terminal block	yellow ⑤		2001-1406 ②	100		
	4-conductor ground terminal block	green-yellow ⑤	2201-1407	2001-1407 ②	100		
	4-conductor shield terminal block	white		2001-1408	100		
	End and intermediate plate; 0.8 mm thick	orange	2002-1492	2002-1492	25	0.8 x 33 x 70 mm / 0.03 x 1.3 x 2.76 inch	
	End and intermediate plate; 0.8 mm thick	gray	2002-1491	2002-1491	25		
	Separator plate; oversized; 2 mm thick	orange	2002-1494	2002-1494	25	2 x 33,4 x 69,45 mm / 0.08 x 1.32 x 2.73 inch	
	Separator plate; oversized; 2 mm thick	gray	2002-1493	2002-1493	25		
<b>Double potential terminal block</b>							
	Double potential terminal block; with double, center marking level	gray	2201-1441	2001-1441 ②	100	4,2 x 37,4 x 69,9 mm / 0.165 x 1.48 x 2.75 inch	800 V/8 kV/3 ①; I <sub>N</sub> 18 A (24 A);
	End and intermediate plate; 0.8 mm thick	orange	2002-1492	2002-1492	25	0.8 x 33 x 70 mm / 0.03 x 1.3 x 2.76 inch	
	End and intermediate plate; 0.8 mm thick	gray	2002-1491	2002-1491	25		
	Separator plate; oversized; 2 mm thick	orange	2002-1494	2002-1494	25	2 x 33,4 x 69,45 mm / 0.08 x 1.32 x 2.73 inch	
	Separator plate; oversized; 2 mm thick	gray	2002-1493	2002-1493	25		

Conductor range: 0.25 ... 2.5 mm<sup>2</sup> "s+f-st"; Push-in termination: 1 ... 4 mm<sup>2</sup> "s" and 0.75 ... 2.5 mm<sup>2</sup> "insulated ferrules; 12 mm"; 22 ... 14 AWG;  
Strip length: 9 ... 11 mm / 0.35 ... 0.43 inch

Accessories: see pages 36 ... 38.

① 800 V = rated voltage;  
8 kV = rated impulse voltage;  
3 = pollution degree

Marking: WMB/WMB Inline/Marking strips

② Suitable for Ex e II applications; 550 V; 17 A

③ Suitable for Ex i applications

Suitable operating tool: see page 39

# WAGO Through/Ground/Shield Terminal Block TOPJOB® S – 2002/2102/2202 Series

## 2.5 (4) mm<sup>2</sup>

1

Image	Description	Color	With Push-Button Item No.	Without Push-Button Item No.	PU	Dimensions (W x H x D)	Electrical Data
<b>2-conductor through terminal block</b>							
	2-conductor through terminal block; with lever	gray	2102-5201	2102-1201	100	5,2 x 32,9 x 61,5 mm / 0.205 x 1.3 x 2.42 inch	800 V/8 kV/3 ①; I <sub>n</sub> 24 A (32 A)
	2-conductor through terminal block; with lever	blue	2102-5204 ③	2102-1204 ③	100		
	2-conductor ground terminal block; with lever	green-yellow	2102-5207	2102-1207	100		
	End and intermediate plate; 0,8 mm thick	orange	2102-1292	2102-1292	25	0,8 x 33 x 61,5 mm / 0.03 x 1.3 x 2.42 inch	
	End and intermediate plate; 0,8 mm thick	gray	2102-1291	2102-1291	25		
	2-conductor through terminal block	gray ②	2202-1201	2002-1201 ②	100	5,2 x 32,9 x 48,5 mm / 0.205 x 1.3 x 1.91 inch	800 V/8 kV/3 ①; I <sub>n</sub> 24 A (32 A); 600 V, 20 A ④; 600 V, 20 A ⑤
	2-conductor through terminal block	blue ②	2202-1204 ③	2002-1204 ②③	100		
	2-conductor through terminal block	orange ②		2002-1202 ②	100		
	2-conductor through terminal block	red ②	2202-1203	2002-1203 ②	100		
	2-conductor through terminal block	black ②	2202-1205	2002-1205 ②	100		
	2-conductor through terminal block	yellow ②		2002-1206 ②	100		
	2-conductor through terminal block	light gray	2202-1209		100		
	2-conductor ground terminal block	green-yellow ②	2202-1207	2002-1207 ②	100		
	2-conductor shield terminal block	white		2002-1208	100		
	End and intermediate plate; 0,8 mm thick	orange	2002-1292	2002-1292	25	0,8 x 33 x 48,5 mm / 0.03 x 1.3 x 1.91 inch	
	End and intermediate plate; 0,8 mm thick	gray	2002-1291	2002-1291	25		
	Separator plate; oversized; 2 mm thick	orange	2002-1294	2002-1294	25		
	Separator plate; oversized; 2 mm thick	gray	2002-1293	2002-1293	25		
	Separator plate Ex e/Ex i; 3 mm thick; 90 mm	orange	209-190	209-190	25		
	Separator plate Ex e/Ex i; 3 mm thick; 120 mm	orange	209-191	209-191	25		
<b>3-conductor through terminal block</b>							
	3-conductor through terminal block; with lever	gray	2102-5301	2102-1301	100	5,2 x 32,9 x 72,2 mm / 0.205 x 1.3 x 2.84 inch	800 V/8 kV/3 ①; I <sub>n</sub> 24 A (30 A)
	3-conductor through terminal block; with lever	blue	2102-5304 ③	2102-1304 ③	100		
	3-conductor ground terminal block; with lever	green-yellow	2102-5307	2102-1307	100		
	End and intermediate plate; 0,8 mm thick	orange	2102-1392	2102-1392	25	0,8 x 33 x 72,2 mm / 0.03 x 1.3 x 2.84 inch	
	End and intermediate plate; 0,8 mm thick	gray	2102-1391	2102-1391	25		
	3-conductor through terminal block	gray ②	2202-1301	2002-1301 ②	100	5,2 x 32,9 x 59,2 mm / 0.205 x 1.3 x 2.33 inch	800 V/8 kV/3 ①; I <sub>n</sub> 24 A (32 A); 600 V, 15 A ④; 600 V, 15 A ⑤
	3-conductor through terminal block	blue ②	2202-1304 ③	2002-1304 ②③	100		
	3-conductor through terminal block	orange ②	2202-1302	2002-1302 ②	100		
	3-conductor through terminal block	red ②	2202-1303	2002-1303 ②	100		
	3-conductor through terminal block	black ②	2202-1305	2002-1305 ②	100		
	3-conductor through terminal block	yellow ②	2202-1306	2002-1306 ②	100		
	3-conductor ground terminal block	green-yellow ②	2202-1307	2002-1307 ②	100		
	3-conductor shield terminal block	white		2002-1308	100		
	3-conductor shield terminal block	white		2002-1308	100		
	End and intermediate plate; 0,8 mm thick	orange	2002-1392	2002-1392	25	0,8 x 33 x 59,5 mm / 0.03 x 1.3 x 2.34 inch	
	End and intermediate plate; 0,8 mm thick	gray	2002-1391	2002-1391	25		
	Separator plate; oversized; 2 mm thick	orange	2002-1394	2002-1394	25		
	Separator plate; oversized; 2 mm thick	gray	2002-1393	2002-1393	25		
	Separator plate Ex e/Ex i; 3 mm thick; 90 mm	orange	209-191	209-191	25		
	Separator plate Ex e/Ex i; 3 mm thick; 120 mm	orange	209-191	209-191	25		
<b>4-conductor through terminal block</b>							
	4-conductor through terminal block	gray ②	2202-1401	2002-1401 ②	100	5,2 x 32,9 x 69,9 mm / 0.205 x 1.3 x 2.75 inch	800 V/8 kV/3 ①; I <sub>n</sub> 24 A (32 A); 600 V, 15 A ④; 600 V, 15 A ⑤
	4-conductor through terminal block	blue ②	2202-1404 ③	2002-1404 ②③	100		
	4-conductor through terminal block	orange ②		2002-1402 ②	100		
	4-conductor through terminal block	red ②		2002-1403 ②	100		
	4-conductor through terminal block	black ②		2002-1405 ②	100		
	4-conductor through terminal block	yellow ②		2002-1406 ②	100		
	4-conductor through terminal block	green	2202-1401/000-001		100		
	4-conductor through terminal block	light gray	2202-1409		100		
	4-conductor ground terminal block	green-yellow ②	2202-1407	2002-1407 ②	100		
	4-conductor shield terminal block	white		2002-1408	100		
	4-conductor shield terminal block	white		2002-1408	100		
	End and intermediate plate; 0,8 mm thick	orange	2002-1492	2002-1492	25	0,8 x 33 x 70 mm / 0.03 x 1.3 x 2.76 inch	
	End and intermediate plate; 0,8 mm thick	gray	2002-1491	2002-1491	25		
	Separator plate; oversized; 2 mm thick	orange	2002-1494	2002-1494	25		
	Separator plate; oversized; 2 mm thick	gray	2002-1493	2002-1493	25		
	Separator plate Ex e/Ex i; 3 mm thick; 120 mm	orange	209-191	209-191	25		

Conductor range: 0.25 ... 4 mm<sup>2</sup> "s+f-st"; Push-in termination: 1 ... 4 mm<sup>2</sup> "s" and 1 ... 2.5 mm<sup>2</sup> "insulated ferrules; 12 mm"; 22 ... 14 AWG;  
Strip length: 10 ... 12 mm / 0.39 ... 0.47 inch  
Accessories: see pages 36 ... 38.

① 800 V = rated voltage;  
8 kV = rated impulse voltage;  
3 = pollution degree

Marking: WMB/WMB Inline/Marking strips







② Suitable for Ex e II applications; 550 V; 22 A  
③ Suitable for Ex i applications

Suitable operating tool: see page 39



# WAGO Double Potential Terminal Block TOPJOB® S – 2002 Series; WAGO Through Terminal Block TOPJOB® S; Angled Type – 2002 Series

## 2.5 (4) mm<sup>2</sup>

Image	Description	Color	With Push-Button Item No.	Without Push-Button Item No.	PU	Dimensions (W x H x D)	Electrical Data
<b>Double potential terminal block</b>							
	Double potential terminal block; with double, center marking level	gray	2202-1441	2002-1441 ②	100	5,2 x 37,4 x 69,9 mm / 0,205 x 1.48 x 2.75 inch	800 V/8 kV/3 ①; I <sub>N</sub> 24 A (32 A)
	End and intermediate plate; 0.9 mm thick	orange	2002-1492	2002-1492	25	0.8 x 33 x 70 mm /	
	End and intermediate plate; 0.9 mm thick	gray	2002-1491	2002-1491	25	0.03 x 1.3 x 2.76 inch	
	Separator plate; oversized; 2 mm thick	orange	2002-1494	2002-1494	25	2 x 33,4 x 69,45 mm /	
	Separator plate; oversized; 2 mm thick	gray	2002-1493	2002-1493	25	0.08 x 1.32 x 2.73 inch	
<b>3-conductor through terminal block; angled type</b>							
	3-conductor through terminal block	gray ⑤	2202-6301	2002-6301 ③	100	5,2 x 38,9 x 52,6 mm / 0,205 x 1.53 x 2.07 inch	800 V/8 kV/3 ①; I <sub>N</sub> 24 A (32 A); 600 V, 15 A ④; 600 V, 15 A ⑥
	3-conductor through terminal block	blue ⑤	2202-6304 ③	2002-6304 ②③	100		
	3-conductor through terminal block	orange ⑤	2202-6302	2002-6302 ③	100		
	3-conductor through terminal block	red ⑤	2202-6303	2002-6303 ③	100		
	3-conductor through terminal block	black ⑤	2202-6305	2002-6305 ③	100		
	3-conductor through terminal block	yellow ⑤	2202-6306	2002-6306 ③	100		
	3-conductor ground terminal block	green-yellow ⑤	2202-6307	2002-6307 ③	100		
	3-conductor shield terminal block	white	2202-6308	2002-6308	100		
	End and intermediate plate; 0.8 mm thick	orange	2002-6392	2002-6392	25	0,8 x 38,9 x 52 mm /	
	End and intermediate plate; 0.8 mm thick	gray	2002-6391	2002-6391	25	0.03 x 1.53 x 2.05 inch	
	Separator plate Ex e/Ex i; 3 mm thick	orange	209-191	209-191	25	3 x 52 x 120 mm / 0.12 x 2.05 x 4.72 inch	
<b>4-conductor through terminal block; angled type; Notice: This terminal block has no jumper slots!</b>							
	4-conductor through terminal block	gray ⑤	2202-6401	2002-6401 ③	100	5,2 x 38,9 x 52,6 mm / 0,205 x 1.53 x 2.07 inch	800 V/8 kV/3 ①; I <sub>N</sub> 24 A (32 A); 600 V, 15 A ④; 600 V, 15 A ⑥
	4-conductor through terminal block	blue ⑤	2202-6404 ③	2002-6404 ②③	100		
	4-conductor through terminal block	orange ⑤	2202-6402	2002-6402 ③	100		
	4-conductor through terminal block	red ⑤	2202-6403	2002-6403 ③	100		
	4-conductor through terminal block	black ⑤	2202-6405	2002-6405 ③	100		
	4-conductor through terminal block	yellow ⑤	2202-6406	2002-6406 ③	100		
	4-conductor ground terminal block	green-yellow ⑤	2202-6407	2002-6407 ③	100		
	End and intermediate plate; 0.8 mm thick	orange	2002-6392	2002-6392	25	0,8 x 38,9 x 52 mm /	
	End and intermediate plate; 0.8 mm thick	gray	2002-6391	2002-6391	25	0.03 x 1.53 x 2.05 inch	
	Separator plate Ex e/Ex i; 3 mm thick	orange	209-191	209-191	25	3 x 52 x 120 mm / 0.12 x 2.05 x 4.72 inch	

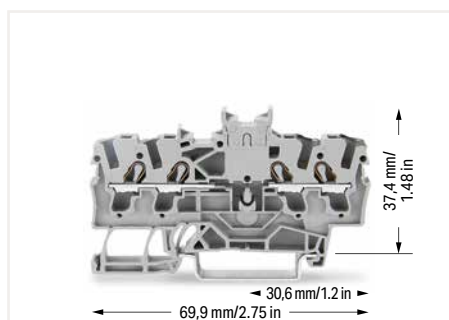

Notice: These double potential terminal blocks cannot be commoned with push-in type jumper bars!  
WAGO's front-entry double potential terminal blocks save space. Two independent feedthrough circuits are placed in one insulated housing on one level in just 5.2 mm. This achieves a width of just 2.6 mm per potential versus standard through terminal blocks. Input and output of a circuit are placed on the same side of the terminal block. Both circuits can be individually marked according to input and output.

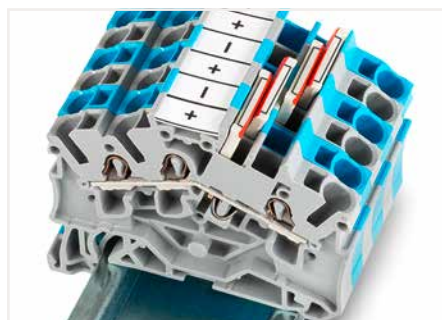

**The 3- and 4-conductor terminal blocks (angled type):**  
WAGO's TOPJOB® S Rail-Mount Terminal Blocks have a 35-degree conductor entry angle permitting a minimal bend radius and an extremely short wiring distance to the cable duct. These are space- and cost-saving solutions for switchgear and control cabinet applications that use the LSC wiring system from Lütze. The design allows a cable duct to be placed very close to the terminal blocks, keeping its height relatively low.



2009-193 Group Marker Carrier (equipped with a marking strip) for all 2001 to 2016 Series TOPJOB® S Rail-Mount Terminal Blocks  
Do not use on an end plate!

Conductor range: 0.25 ... 4 mm<sup>2</sup> "s+f-st"; Push-in termination: 1 ... 4 mm<sup>2</sup> "s" and 1 ... 2.5 mm<sup>2</sup> "insulated ferrules; 12 mm"; 22 ... 14 AWG;  
Strip length: 10 ... 12 mm / 0.39 ... 0.47 inch

Accessories: see pages 36 ... 38.

① 800 V = rated voltage;  
8 kV = rated impulse voltage;  
3 = pollution degree

Marking: WMB/WMB Inline/Marking strips

② Suitable for Ex e II applications; 550 V; 22 A

③ Suitable for Ex i applications

Suitable operating tool: see page 39

# WAGO Through/Ground/Shield Terminal Block TOPJOB® S – 2004/2104/2204 Series

## 4 (6) mm<sup>2</sup>

1

Image	Description	Color	With Push-Button Item No.	Without Push-Button Item No.	PU	Dimensions (W x H x D)	Electrical Data
<b>2-conductor through terminal block</b>							
	2-conductor through terminal block; with lever	gray	2104-5201	2104-1201	50	6,2 x 32,9 x 70 mm / 0.24 x 1.3 x 2.76 inch	800 V/8 kV/3 ①; I <sub>n</sub> 32 A (40 A)
	2-conductor through terminal block; with lever	blue ⑤	2104-5204 ③	2104-1204 ③	50		
	2-conductor ground terminal block; with lever	green-yellow	2104-5207	2104-1207	50		
	End and intermediate plate; 0,8 mm thick	orange	2104-1292	2104-1292	25	1 x 30,5 x 69,5 mm / 0.04 x 1.2 x 2.74 inch	
	End and intermediate plate; 0,8 mm thick	gray	2104-1291	2104-1291	25		
	2-conductor through terminal block	gray ⑤	2204-1201	2004-1201 ②	50	6,2 x 32,9 x 52,3 mm / 0.224 x 1.3 x 2.06 inch	800 V/8 kV/3 ①; I <sub>n</sub> 32 A (41 A); 600 V, 30 A ④; 600 V, 30 A ⑤
	2-conductor through terminal block	blue ⑤	2204-1204 ③	2004-1204 ②③	50		
	2-conductor through terminal block	orange ⑤		2004-1202 ②	50		
	2-conductor through terminal block	red ⑤		2004-1203 ②	50		
	2-conductor through terminal block	black ⑤		2004-1205 ②	50		
	2-conductor through terminal block	yellow ⑤		2004-1206 ②	50		
	2-conductor ground terminal block	green-yellow ⑤	2204-1207	2004-1207 ②	50		
	End and intermediate plate; 1 mm thick	orange	2004-1292	2004-1292	25		
	End and intermediate plate; 1 mm thick	gray	2004-1291	2004-1291	25	1 x 32,9 x 52,5 mm / 0.04 x 1.3 x 2.07 inch	
	Separator plate; oversized; 2 mm thick	orange	2004-1294	2004-1294	25		
	Separator plate; oversized; 2 mm thick	gray	2004-1293	2004-1293	25		
	Separator plate Ex e/Ex i; 3 mm thick; 90 mm	orange	209-190	209-190	25		
	Separator plate Ex e/Ex i; 3 mm thick; 120 mm	orange	209-191	209-191	25		
<b>3-conductor through terminal block</b>							
	3-conductor through terminal block; with lever	gray	2104-5301	2104-1301	50	6,2 x 32,9 x 83,2 mm / 0.24 x 1.3 x 3.28 inch	800 V/8 kV/3 ①; I <sub>n</sub> 32 A (40 A)
	3-conductor through terminal block; with lever	blue ⑤	2104-5304 ③	2104-1304 ③	50		
	3-conductor ground terminal block; with lever	green-yellow	2104-5307	2104-1307	50		
	End and intermediate plate; 0,8 mm thick	orange	2104-1392	2104-1392	25	1 x 30,5 x 69,5 mm / 0.04 x 1.2 x 2.74 inch	
	End and intermediate plate; 0,8 mm thick	gray	2104-1391	2104-1391	25		
	3-conductor through terminal block	gray ⑤	2204-1301	2004-1301 ②	50	6,2 x 32,9 x 82,7 mm / 0.244 x 1.3 x 3.26 inch	800 V/8 kV/3 ①; I <sub>n</sub> 32 A (41 A); 600 V, 30 A ④; 600 V, 30 A ⑤
	3-conductor through terminal block	blue ⑤	2204-1304 ③	2004-1304 ②③	50		
	3-conductor through terminal block	orange ⑤		2004-1302 ②	50		
	3-conductor through terminal block	red ⑤		2004-1303 ②	50		
	3-conductor through terminal block	black ⑤		2004-1305 ②	50		
	3-conductor through terminal block	yellow ⑤		2004-1306 ②	50		
	3-conductor ground terminal block	green-yellow ⑤	2204-1307	2004-1307 ②	50		
	End and intermediate plate; 1 mm thick	orange	2004-1392	2004-1392	25	1 x 32,9 x 65,5 mm / 0.04 x 1.3 x 2.56 inch	
	End and intermediate plate; 1 mm thick	gray	2004-1391	2004-1391	25		
	Separator plate; oversized; 2 mm thick	orange	2004-1394	2004-1394	25		
	Separator plate; oversized; 2 mm thick	gray	2004-1393	2004-1393	25		
	Separator plate Ex e/Ex i; 3 mm thick; 120 mm	orange	209-191	209-191	25		

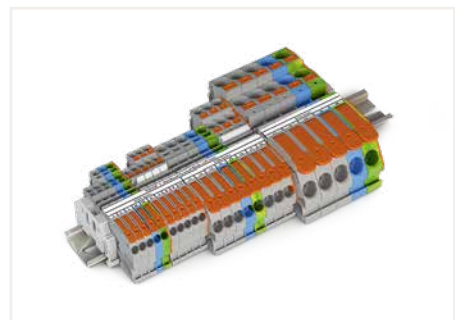
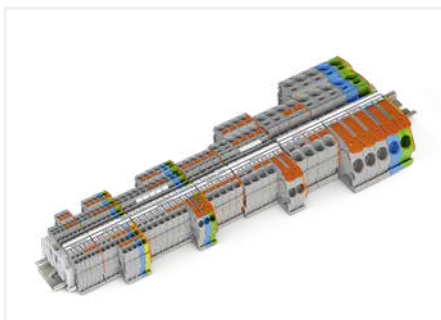

Conductor range: 0.5 ... 6 mm<sup>2</sup> "s+f-st"; Push-in termination: 1.5 ... 6 mm<sup>2</sup> "s" and 1.5 ... 4 mm<sup>2</sup> "insulated ferrules; 12 mm"; 20 ... 10 AWG;  
Strip length: 11 ... 13 mm / 0.43 ... 0.51 inch  
Accessories: see pages 36 ... 38.

① 800 V = rated voltage;  
8 kV = rated impulse voltage;  
3 = pollution degree



Marking: WMB/WMB Inline/Marking strips

② Suitable for Ex e II applications; 550 V; 30 A  
③ Suitable for Ex i applications

Suitable operating tool: see page 39

# WAGO Through/Ground/Shield Terminal Block TOPJOB® S – 2004/2204 Series

## 4 (6) mm<sup>2</sup>

Image	Description	Color	With Push-Button Item No.	Without Push-Button Item No.	PU	Dimensions (W x H x D)	Electrical Data
<b>4-conductor through terminal block</b>							
	4-conductor through terminal block	gray ☉	2204-1401	2004-1401 ②	50	6,2 x 32,9 x 78,7 mm / 0.244 x 1.3 x 3.1 inch	800 V/8 kV/3 ①; I <sub>n</sub> 32 A (41 A); 600 V, 30 A ②; 600 V, 30 A ③
	4-conductor through terminal block	blue ☉	2204-1404 ③	2004-1404 ②③	50		
	4-conductor through terminal block	orange ☉		2004-1402 ②	50		
	4-conductor through terminal block	red ☉		2004-1403 ②	50		
	4-conductor through terminal block	black ☉		2004-1405 ②	50		
	4-conductor through terminal block	yellow ☉		2004-1406 ②	50		
	4-conductor ground terminal block	green-yellow ☉	2204-1407	2004-1407 ②	50		
	4-conductor shield terminal block	white		2004-1408	50		
	End and intermediate plate; 1 mm thick	orange	2004-1492	2004-1492	25	1 x 32,9 x 79 mm / 0.04 x 1.3 x 3.11 inch	
	End and intermediate plate; 1 mm thick	gray	2004-1491	2004-1491	25		
	Separator plate; oversized; 2 mm thick	orange	2004-1494	2004-1494	25	2 x 34,7 x 78 mm / 0.08 x 1.37 x 3.07 inch	
	Separator plate; oversized; 2 mm thick	gray	2004-1493	2004-1493	25		
	Separator plate Ex e/Ex i; 3 mm thick; 120 mm	orange	209-191	209-191	25	3 x 52 x 120 mm / 0.12 x 2.05 x 4.72 inch	



**Marking example (rear)**  
The embossed details on the terminal blocks show the manufacturer's name, the series no., the type of protection Ex e II, the approval no., the approval data and the name of the testing authority.



Through terminal blocks with a blue insulated housing are suitable for Ex i applications.



All through and ground conductor terminal blocks are suitable for Ex e II applications.

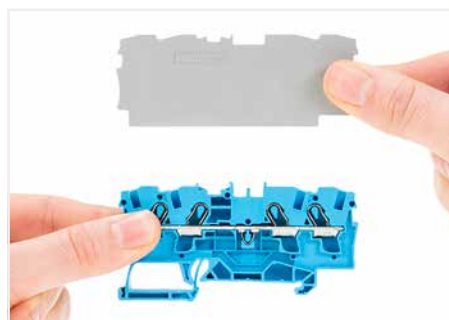

**Separator plate for Ex e/Ex i applications**  
An end plate must be applied to the terminal block located directly behind an Ex e/Ex i separator plate.



**Ex e II/Ex i terminal strip**  
**Notice:**  
The movable feet of terminal blocks and separator plates must face the same direction.

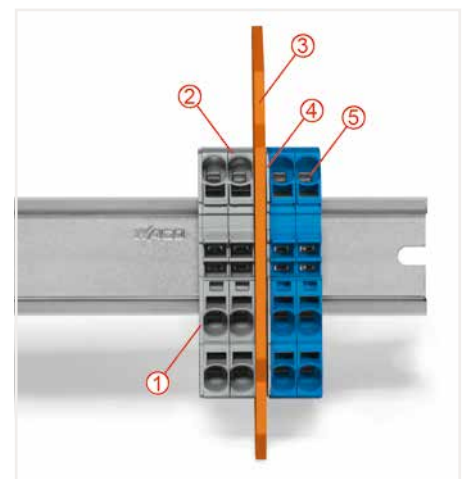

A separator plate is located between the Ex e II and Ex i terminal strip. A distance of 50 mm is required from connection point to connection point.

- ① End plate
- ② Ex e II terminal blocks
- ③ Ex e/Ex i separator plate
- ④ End plate
- ⑤ Ex i terminal blocks

Conductor range: 0.5 ... 6 mm<sup>2</sup> "s+f-st"; Push-in termination: 1.5 ... 6 mm<sup>2</sup> "s" and 1.5 ... 4 mm<sup>2</sup> "insulated ferrules; 12 mm"; 20 ... 10 AWG;  
Strip length: 11 ... 13 mm / 0.43 ... 0.51 inch  
Accessories: see pages 36 ... 38.

① 800 V = rated voltage;  
8 kV = rated impulse voltage;  
3 = pollution degree

Marking: WMB/WMB Inline/Marking strips

② Suitable for Ex e II applications; 550 V; 30 A  
③ Suitable for Ex i applications

Suitable operating tool: see page 39

# WAGO Through/Ground/Shield Terminal Block TOPJOB® S – 2006/2106/2206 Series

## 6 (10) mm<sup>2</sup>

1

Image	Description	Color	With Push-Button Item No.	Without Push-Button Item No.	PU	Dimensions (W x H x D)	Electrical Data
<b>2-conductor through terminal block</b>							
	2-conductor through terminal block; with lever	○ gray	2106-5201	2106-1201	25	7,5 x 32,9 x 74,8 mm / 0.295 x 1.3 x 2.94 inch	800 V/8 kV/3 ①; I <sub>n</sub> 41 A (55 A);
	2-conductor through terminal block; with lever	● blue	2106-5204 ②	2106-1204 ②	25		
	2-conductor ground terminal block; with lever	● green-yellow	2106-5207	2106-1207	25		
	End and intermediate plate; 0,8 mm thick	● orange	2106-1292	2106-1292	25	1 x 32,9 x 74,8 mm /	
	End and intermediate plate; 0,8 mm thick	○ gray	2106-1291	2106-1291	25		
	2-conductor through terminal block	○ gray ③	2206-1201	2006-1201 ②	50	7,5x 32,9 x 57,4 mm / 0.295 x 1.3 x 2.26 inch	800 V/8 kV/3 ①; I <sub>n</sub> 41 A (57 A); 600 V, 50 A ④; 600 V, 50 A ⑤
	2-conductor through terminal block	● blue ③	2206-1204 ③	2006-1204 ②③	50		
	2-conductor through terminal block	● orange ③		2006-1202 ②	50		
	2-conductor through terminal block	● green	2206-1201/000-001		50		
	2-conductor ground terminal block	● green-yellow ③	2206-1207	2006-1207 ②	50		
	2-conductor shield terminal block	○ white		2006-1208	50		
	End and intermediate plate; 1 mm thick	● orange	2006-1292	2006-1292	25	1 x 32,9 x 57,5 mm / 0.04 x 1.3 x 2.26 inch	
	End and intermediate plate; 1 mm thick	○ gray	2006-1291	2006-1291	25		
	Separator plate; oversized; 2 mm thick	● orange	2006-1294	2006-1294	25		
	Separator plate; oversized; 2 mm thick	○ gray	2006-1293	2006-1293	25		
<b>3-conductor through terminal block</b>							
	3-conductor through terminal block; with lever	○ gray	2106-5301	2106-1301	25	7,5 x 32,9 x 90,8 mm / 0.295 x 1.3 x 3.57 inch	800 V/8 kV/3 ①; I <sub>n</sub> 41 A (55 A);
	3-conductor through terminal block; with lever	● blue	2106-5304 ②	2106-1304 ②	25		
	3-conductor ground terminal block; with lever	● green-yellow	2106-5307	2106-1307	25		
	End and intermediate plate; 0,8 mm thick	● orange	2106-1392	2106-1392	25	1 x 32,9 x 90,8 mm /	
	End and intermediate plate; 0,8 mm thick	○ gray	2106-1391	2106-1391	25		
	3-conductor through terminal block	○ gray ③	2206-1301	2006-1301 ②	25	7,5 x 32,9 x 73,3 mm / 0.295 x 1.3 x 2.89 inch	800 V/8 kV/3 ①; I <sub>n</sub> 41 A (57 A); 600 V, 15 A ④; 600 V, 15 A ⑤
	3-conductor through terminal block	● blue ③	2206-1304 ③	2006-1304 ②③	25		
	3-conductor through terminal block	● orange ③		2006-1302 ②	25		
	3-conductor through terminal block	● black ③		2006-1305 ②	25		
	3-conductor through terminal block	● green	2206-1301/000-001		25		
	3-conductor ground terminal block	● green-yellow ③	2206-1307	2006-1307 ②	25		
	End and intermediate plate; 1 mm thick	● orange	2006-1392	2006-1392	25	1 x 32,9 x 73,5 mm / 0.04 x 1.3 x 2.89 inch	
	End and intermediate plate; 1 mm thick	○ gray	2006-1391	2006-1391	25		
	Separator plate; oversized; 2 mm thick	● orange	2006-1394	2006-1394	25		
	Separator plate; oversized; 2 mm thick	○ gray	2006-1393	2006-1393	25		

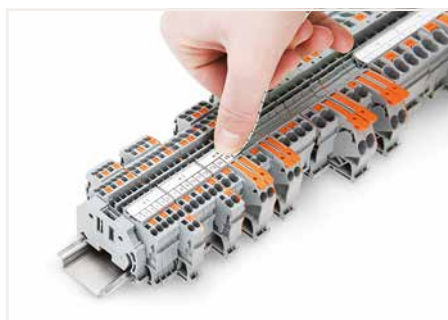

Snapping a marking strip into a marker slot.



Snapping a marking strip into the marker slot.



Combining terminal blocks with/without a push-button.

Conductor range: 0.5 ... 10 mm<sup>2</sup> "s+f-st"; Push-in termination: 2.5 ... 10 mm<sup>2</sup> "s" and 2.5 ... 6 mm<sup>2</sup> "insulated ferrules; 12 mm"; 20 ... 8 AWG;  
Strip length: 13 ... 15 mm / 0.51 ... 0.59 inch

Accessories: see pages 36 ... 38.









① 800 V = rated voltage;  
8 kV = rated impulse voltage;  
3 = pollution degree

Marking: WMB/WMB Inline/Marking strips

② Suitable for Ex e II applications; 550 V; 38 A  
③ Suitable for Ex i applications

Suitable operating tool: see page 39

## WAGO Through/Ground/Shield Terminal Block TOPJOB® S – 2010/2110/2210 Series 10 (16) mm<sup>2</sup>

Image	Description	Color	With Push-Button Item No.	Without Push-Button Item No.	PU	Dimensions (W x H x D)	Electrical Data
<b>2-conductor through terminal block</b>							
	2-conductor through terminal block; with lever	gray	2110-5201	2110-1201	25	10 x 36,9 x 89 mm / 0.394 x 1.45 x 3.5 inch	800 V/8 kV/3 ①; I <sub>N</sub> 57 A (74 A)
	2-conductor through terminal block; with lever	blue	2110-5204 ③	2110-1204 ③	25		
	2-conductor ground terminal block; with lever	green-yellow	2110-5207	2110-1207	25		
	End and intermediate plate; 1 mm thick	orange	2110-1292	2110-1292	25	1 x 36,9 x 89 mm / 0.04 x 1.45 x 3.5 inch	
	End and intermediate plate; 1 mm thick	gray	2110-1291	2110-1291	25		
	2-conductor through terminal block	gray ⑤	2210-1201	2010-1201 ②	25	10 x 36,9 x 67,8 mm / 0.394 x 1.45 x 2.67 inch	800 V/8 kV/3 ①; I <sub>N</sub> 57 A (76 A); 600 V, 65 A ④; 600 V, 65 A ⑥
	2-conductor through terminal block	blue ⑤	2210-1204 ③	2010-1204 ②③	25		
	2-conductor through terminal block	orange ⑤		2010-1202 ②	25		
	2-conductor through terminal block	black ⑤		2010-1205 ②	25		
	2-conductor ground terminal block	green-yellow ⑤	2210-1207	2010-1207 ②	25		
	2-conductor shield terminal block	white		2010-1208	25		
	2-conductor shield terminal block	white		2010-1208	25		
	End and intermediate plate; 1 mm thick	orange	2010-1292	2010-1292	25	1 x 33,5 x 67,2 mm / 0.04 x 1.32 x 2.65 inch	
	End and intermediate plate; 1 mm thick	gray	2010-1291	2010-1291	25		
	Separator plate Ex e/Ex i; 3 mm thick; 120 mm	orange	209-191	209-191	25		
<b>3-conductor through terminal block</b>							
	3-conductor through terminal block; with lever	gray	2110-5301	2110-1301	25	10 x 36,9 x 110,4 mm / 0.394 x 1.45 x 4.35 inch	800 V/8 kV/3 ①; I <sub>N</sub> 57 A (74 A)
	3-conductor through terminal block; with lever	blue	2110-5304 ③	2110-1304 ③	25		
	3-conductor ground terminal block; with lever	green-yellow	2110-5307	2110-1307	25		
	End and intermediate plate; 1 mm thick	orange	2110-1392	2110-1392	25	1 x 36,9 x 89 mm / 0.04 x 1.45 x 3.5 inch	
	End and intermediate plate; 1 mm thick	gray	2110-1391	2110-1391	25		
	3-conductor through terminal block	gray ⑤	2210-1301	2010-1301 ②	25	10 x 36,9 x 89 mm / 0.394 x 1.45 x 3.5 inch	800 V/8 kV/3 ①; I <sub>N</sub> 57 A (76 A); 600 V, 65 A ④; 600 V, 65 A ⑥
	3-conductor through terminal block	blue ⑤	2210-1304 ③	2010-1304 ②③	25		
	3-conductor through terminal block	orange ⑤		2010-1302 ②	25		
	3-conductor through terminal block	black ⑤		2010-1305 ②	25		
	3-conductor ground terminal block	green-yellow ⑤	2210-1307	2010-1307 ②	25		
	3-conductor ground terminal block	green-yellow ⑤	2210-1307	2010-1307 ②	25		
	End and intermediate plate; 1 mm thick	orange	2010-1392	2010-1392	25	1 x 33,5 x 88,6 mm / 0.04 x 1.32 x 3.49 inch	
	End and intermediate plate; 1 mm thick	gray	2010-1391	2010-1391	25		



Commoning with step-down jumpers.



Insert a push-in type jumper bar and push down until it hits the backstop.

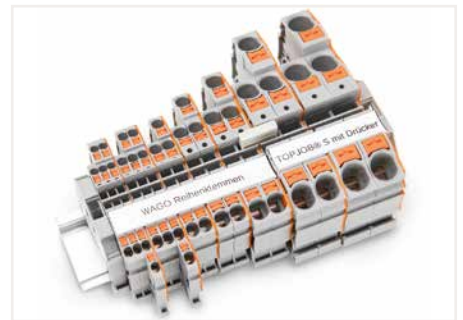

Use the same accessories for all terminal blocks.

Conductor range: 0.5 ... 16 mm<sup>2</sup> "s+f-st"; Push-in termination: 4 ... 16 mm<sup>2</sup> "s" and 4 ... 10 mm<sup>2</sup> "insulated ferrules; 12 mm"; 20 ... 6 AWG;  
Strip length: 17 ... 19 mm / 0.67 ... 0.75 inch

Accessories: see pages 36 ... 38.

① 800 V = rated voltage;  
8 kV = rated impulse voltage;  
3 = pollution degree

Marking: WMB/WMB Inline/Marking strips

② Suitable for Ex e II applications; 550 V; 51 A  
③ Suitable for Ex i applications

Suitable operating tool: see page 39

# WAGO Through/Ground/Shield Terminal Block TOPJOB® S – 2016/2116/2216 Series

## 16 (25 "f-st") mm<sup>2</sup>

1

Image	Description	Color	With Push-Button Item No.	Without Push-Button Item No.	PU	Dimensions (W x H x D)	Electrical Data
<b>2-conductor through terminal block</b>							
	2-conductor through terminal block; with lever	gray	2116-5201	2116-1201	20	12 x 36,9 x 91,5 mm / 0.472 x 1.45 x 3.6 inch	800 V/8 kV/3 ①; I <sub>n</sub> 76 A (90 A);
	2-conductor through terminal block; with lever	blue	2116-5204 ④	2116-1204 ③	20		
	2-conductor ground terminal block; with lever	green-yellow	2116-5207	2116-1207	20		
	End and intermediate plate; 1 mm thick	orange	2116-1292	2116-1292	25	1 x 36,5 x 91 mm / 0.04 x 1.44 x 3.58 inch	
	End and intermediate plate; 1 mm thick	gray	2116-1291	2116-1291	25		
<b>2-conductor through terminal block</b>							
	2-conductor through terminal block	gray ⑤	2216-1201	2016-1201 ②	20	12 x 36,9 x 69,8 mm / 0.472 x 1.45 x 2.75 inch	800 V/8 kV/3 ①; I <sub>n</sub> 76 A (90 A); 600 V, 85 A ⑥; 600 V, 80 A ⑥
	2-conductor through terminal block	blue ⑤	2216-1204 ④	2016-1204 ②③	20		
	2-conductor through terminal block	orange ⑤		2016-1202 ②	20		
	2-conductor through terminal block	red ⑤		2016-1203 ②	20		
	2-conductor ground terminal block	green-yellow ⑤	2216-1207	2016-1207 ②	20		
	2-conductor shield terminal block	white		2016-1208	20		
	End and intermediate plate; 1 mm thick	orange	2016-1292	2016-1292	25	1 x 36,5 x 73 mm / 0.04 x 1.44 x 2.87 inch	
	End and intermediate plate; 1 mm thick	gray	2016-1291	2016-1291	25		
	Separator plate Ex e/Ex i; 3 mm thick; 120 mm	orange	209-191	209-191	25		3 x 52 x 120 mm / 0.12 x 2.05 x 4.72 inch
<b>3-conductor through terminal block</b>							
	3-conductor through terminal block; with lever	gray	2116-5301	2116-1301	20	12 x 36,9 x 113,5 mm / 0.472 x 1.45 x 4.47 inch	800 V/8 kV/3 ①; I <sub>n</sub> 76 A (90 A);
	3-conductor through terminal block; with lever	blue	2116-5304 ④	2116-1304 ③	20		
	3-conductor ground terminal block; with lever	green-yellow	2116-5307	2116-1307	20		
	End and intermediate plate; 1 mm thick	orange	2116-1392	2116-1392	25	1 x 36,5 x 113,5 mm / 0.04 x 1.44 x 4.47 inch	
	End and intermediate plate; 1 mm thick	gray	2116-1391	2116-1391	25		
<b>3-conductor through terminal block</b>							
	3-conductor through terminal block	gray ⑤	2216-1301	2016-1301 ②	20	12 x 36,9 x 91,8 mm / 0.472 x 1.45 x 3.61 inch	800 V/8 kV/3 ①; I <sub>n</sub> 76 A (90 A); 600 V, 85 A ⑥; 600 V, 80 A ⑥
	3-conductor through terminal block	blue ⑤	2216-1304 ④	2016-1304 ②③	20		
	3-conductor through terminal block	orange ⑤		2016-1302 ②	20		
	3-conductor through terminal block	red ⑤		2016-1303 ②	20		
	3-conductor through terminal block	black ⑤		2016-1305 ②	20		
	3-conductor through terminal block	yellow ⑤		2016-1306 ②	20		
	3-conductor ground terminal block	green-yellow ⑤	2216-1307	2016-1307 ②	20		
	End and intermediate plate; 1 mm thick	orange	2016-1392	2016-1392	25	1 x 36,5 x 91,4 mm / 0.04 x 1.44 x 3.6 inch	
	End and intermediate plate; 1 mm thick	gray	2016-1391	2016-1391	25		
<b>Three-phase set</b>							
	Three-phase set; with orange end plate; with 2-conductor rail-mount terminal blocks; with lever and operating slot; 16 mm <sup>2</sup>			2116-1201/605-038		61 x 36,9 x 91,5 mm / 2.4 x 1.45 x 3.6 inch	

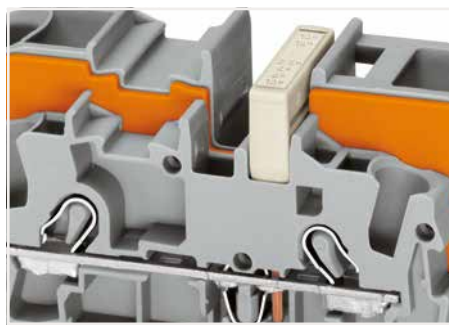

Commoning with step-down jumpers.

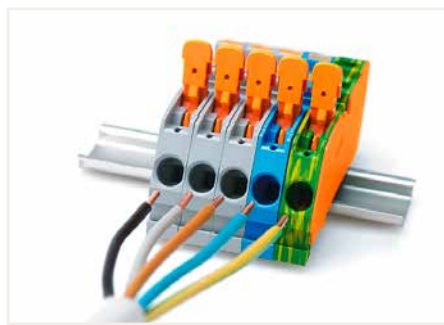

Terminal blocks with levers are ideal for field-wiring connections.

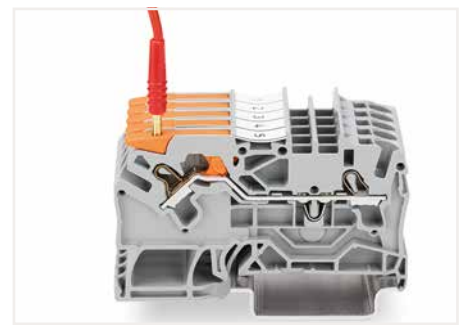

Testing with a 2 mm Ø test plug (max. 42 V).

Conductor range: 0.5 ... 16 mm<sup>2</sup> "s+f-st"; Push-in termination: 6 ... 16 mm<sup>2</sup> "s" and 6 ... 16 mm<sup>2</sup> "insulated ferrules; 18 mm"; 20 ... 4 AWG; Strip length: 18 ... 20 mm / 0.71 ... 0.79 inch  
Accessories: see pages 36 ... 38.

① 800 V = rated voltage; 8 kV = rated impulse voltage; 3 = pollution degree

Marking: WMB/WMB Inline/Marking strips

② Suitable for Ex e II applications; 550 V; 51 A  
③ Suitable for Ex i applications

Suitable operating tool: see page 39

## WAGO High-Current Rail-Mount Terminal Blocks – 285 Series Operation

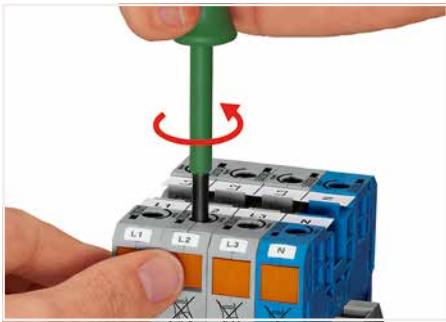

**Conductor termination (35 mm<sup>2</sup>) – step 1**  
Rotate the operating tool (5.5 mm blade width) counter-clockwise. Next, push in the orange locking tab. The clamp is locked open for hands-free wiring.

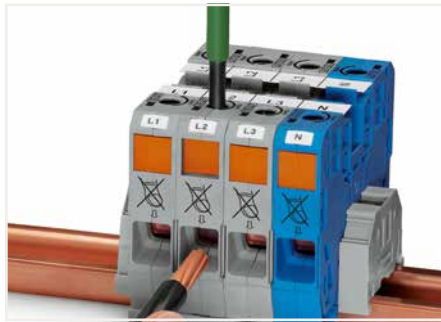

**Conductor termination (35 mm<sup>2</sup>) – step 2**  
Insert a stripped conductor into the clamping unit until it hits the backstop. Hold in this position.

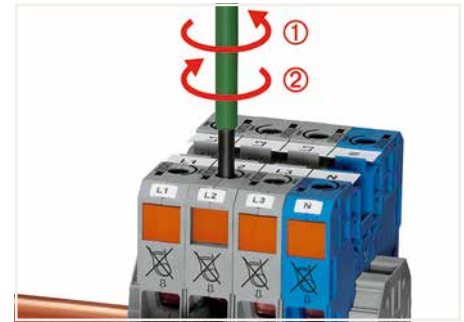

**Conductor termination (35 mm<sup>2</sup>) – step 3**  
A short counter-clockwise rotation closes the clamp, securing the conductor ①. When unlocked, allow the operating tool to rotate clockwise ② to securely terminate the conductor.



**Conductor termination (50, 95 and 185 mm<sup>2</sup>) – step 1**  
Rotate the T-wrench counter-clockwise to the stop ①. Next, push in the orange locking tab. The clamp is locked open for hands-free wiring.



**Conductor termination (50, 95 and 185 mm<sup>2</sup>) – step 2**  
Insert a stripped conductor into the clamping unit until it hits the backstop. Hold in this position.



**Conductor termination (50, 95 and 185 mm<sup>2</sup>) – step 3**  
A short counter-clockwise rotation ② releases the tab. When unlocked, the T-wrench rotates clockwise, securely clamping the conductor.

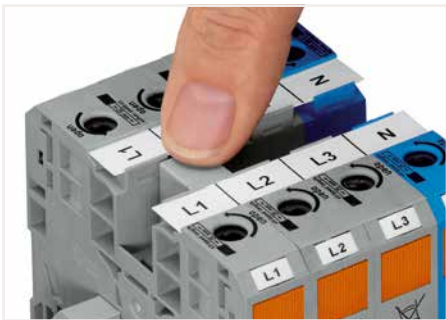

**Commoning (35 mm<sup>2</sup>):**  
Commoning adjacent terminal blocks using a centrally positioned push-in jumper. Use an operating tool to remove the conductor.

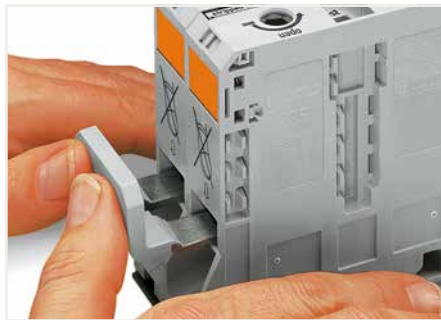

**Commoning (50, 95 and 185 mm<sup>2</sup>):**  
Commoning with an adjacent jumper: insert the jumper above the conductor entry hole prior to conductor termination. The nominal cross-section remains unchanged.



**Commoning 35 mm<sup>2</sup> (2 AWG) high-current terminal blocks with 10/16 mm<sup>2</sup> (8/6 AWG) TOPJOP® S Terminal Blocks using step-down jumpers.**



**Easy troubleshooting via 4 mm Ø touch-proof test plug.** A test plug adapter (283-404) is used for the 35 mm<sup>2</sup> (2 AWG) terminal block. (Test plugs are not available from WAGO, but are offered by industry suppliers such as Multi-Contact Deutschland GmbH.)







**Always push voltage tap (283-407) down into the terminal block until fully inserted!**



**Easily and consistently tap directly into the power supply.** Insert the unwired tap before opening the clamping unit.

# WAGO High-Current Through/Ground Terminal Block – 285 Series

## 35 / 50 (70 "f-st") / 95 / 185 mm<sup>2</sup>

Image	Description	Color	Item No.	PU	Dimensions (W x H x D)	Electrical Data
<b>35 mm<sup>2</sup>; High-current through/ground terminal block ①</b>						
	2-conductor through terminal block; only for DIN 35 x 15 rail	○ gray	285-135	15	16 x 63 x 86 mm / 0.63 x 2.48 x 3.99 inch	1000 V/8 kV/3 ⑤; I <sub>N</sub> 125 A; 600 V, 115 A ⑧; 600 V, 115 A ⑨
		● blue	285-134	15		
		● brown	285-132	15		
		● red	285-133	15		
		● black	285-136	15		
		○ light gray ⑥	285-935 ⑥	15		
	● dark gray/yellow	285-131	15			
2-conductor ground terminal block; only for DIN 35 x 15 rail; 2.3 mm thick	● green-yellow	285-137	15			
	● green-yellow ⑥	285-137/999-950 ⑥	15			
<b>50 (70 "f-st") mm<sup>2</sup>; High-current through/ground terminal block ②</b>						
	2-conductor through terminal block; only for DIN 35 x 15 rail	○ gray	285-150	5	20 x 87 x 94 mm / 0.79 x 3.43 x 3.7 inch	1000 V/8 kV/3 ⑤; I <sub>N</sub> 150 A; 600 V, 150 A ⑧; 600 V, 150 A ⑨
		● blue	285-154	5		
		○ light gray ⑥	285-950 ⑦	5		
		● dark gray/yellow	285-151	5		
	● green-yellow	285-157	5			
2-conductor ground terminal block; only for DIN 35 x 15 rail; 2.3 mm thick; copper	● green-yellow ⑥	285-157/999-950 ⑦	5			
	2-conductor through terminal block; with mounting flanges	○ gray	285-141	5	20 x 94 x 130 mm / 0.79 x 3.7 x 5.12 inch	1000 V/8 kV/3 ⑤; I <sub>N</sub> 150 A
		● blue	285-144	5		
		○ light gray ⑥	285-143 ⑦	5		
		● dark gray/yellow	285-147	5		
	● dark gray/yellow ⑥	285-147/999-950 ⑦	5			
<b>95 mm<sup>2</sup>; High-current through/ground terminal block ③</b>						
	2-conductor through terminal block; only for DIN 35 x 15 rail	○ gray	285-195	5	25 x 101 x 107 mm / 0.98 x 3.98 x 4.21 inch	1000 V/8 kV/3 ⑤; I <sub>N</sub> 232 A; 600 V, 200 A ⑧; 600 V, 210 A ⑨
		● blue	285-194	5		
		○ light gray ⑥	285-995 ⑧	5		
		● dark gray/yellow	285-191	5		
	● green-yellow	285-197	5			
2-conductor ground terminal block; only for DIN 35 x 15 rail; 2.3 mm thick; copper	● green-yellow ⑥	285-197/999-950 ⑧	5			
	2-conductor through terminal block; with mounting flanges	○ gray	285-181	5	25 x 108 x 145 mm / 0.98 x 4.25 x 5.71 inch	1000 V/8 kV/3 ⑤; I <sub>N</sub> 232 A
		● blue	285-184	5		
		● dark gray/yellow	285-187	5		
		● dark gray/yellow ⑥	285-187/999-950 ⑧	5		
<b>185 mm<sup>2</sup>; High-current through/ground terminal block ④</b>						
	2-conductor through terminal block; only for DIN 35 x 15 rail	○ gray	285-1185	5	32 x 116 x 130 mm / 1.26 x 4.57 x 5.12 inch	1000 VAC/DC/ 1500 VDC/ 12 kV/3 ⑤; I <sub>N</sub> 353 A
		● blue	285-1184	5		
		○ light gray ⑥	285-1189 ⑨	5		
		● dark gray/yellow	285-1181	5		
	● green-yellow	285-1187	5			
2-conductor ground terminal block; only for DIN 35 x 15 rail; 2.3 mm thick; copper	● green-yellow ⑥	285-1187/999-950 ⑨	5			
	2-conductor through terminal block; with mounting flanges	○ gray	285-1161	4	32 x 123 x 170 mm / 1.26 x 4.84 x 6.69 inch	1000 VAC/DC/ 1500 VDC/ 12 kV/3 ⑤; I <sub>N</sub> 353 A
		● blue	285-1164	4		
		○ light gray ⑥	285-1163 ⑨	4		
		● dark gray/yellow	285-1167	4		
		● dark gray/yellow ⑥	285-1167/999-950 ⑨	4		

① 6 ... 35 mm<sup>2</sup>; 10 ... 2 AWG; Strip length: 25 mm / 0.98 inch

② 10 ... 50 (70 "f-st") mm<sup>2</sup>; 8 ... 1/0 AWG; Strip length: 30 mm / 1.18 inch

③ 25 ... 95 mm<sup>2</sup>; 4 ... 4/0 AWG; Strip length: 35 mm / 1.38 inch

④ 50 ... 185 mm<sup>2</sup>; 1/0 AWG ... 350 kcmil; Strip length: 45 ... 47 mm / 1.77 ... 1.85 inch

⑤ 1000 V / 1000 VAC/DC / 1500 VDC = rated voltage  
8/12 kV = rated impulse voltage  
3 = pollution degree

⑥ Suitable for Ex e II applications; 880 V; 101 A

⑦ Suitable for Ex e II applications; 880 V; 134 A

⑧ Suitable for Ex e II applications; 880 V; 211 A

⑨ Suitable for Ex e II applications; 1000 V; 250 A

Marking: WMB/WMB Inline/Marking strips

Suitable operating tool: see page 31



## Accessories for WAGO High-Current Through/Ground Terminal Block

Image	Description	35 mm <sup>2</sup>	PU	50 mm <sup>2</sup>	PU	95 mm <sup>2</sup>	PU	185 mm <sup>2</sup>	PU
	Voltage tap; I <sub>N</sub> 32 A	○ 285-427	5						
	Voltage tap; I <sub>N</sub> 41 A			○ 285-447	5				
	Voltage tap; I <sub>N</sub> 57 A					○ 285-407	5		
	Voltage tap; I <sub>N</sub> 57 A							○ 285-1175	5
	Current and voltage tap; 150 A			● 855-501/ 150-000	1				
	Current and voltage tap; 250 A					● 855-951/ 250-000	1		
	Current and voltage tap; 350 A							● 855-1851/ 350-000	1
	Adjacent jumper; insulated; I <sub>N</sub> 85 A	○ 285-435	25						
	Adjacent jumper; insulated; I <sub>N</sub> 150 A, for 1 jumper; I <sub>N</sub> 150 A, for 2 ... 4 jumpers			○ 285-450	25				
	Adjacent jumper; insulated; I <sub>N</sub> 232 A, for 1 jumper; I <sub>N</sub> 192 A, for 2 ... 4 jumpers					○ 285-495	25		
	Adjacent jumper; insulated; I <sub>N</sub> 309 A							○ 285-1171	25
	Protective warning marker; with a black high-voltage symbol	● 285-420	25	● 285-440	25	● 285-170	25	● 285-1177	25
	Protective warning marker; with two black high-voltage symbols			● 285-449	25	● 285-175	25	● 285-1176	25
	Finger guard; touch-proof cover protects unused conductor entries	● 285-421	25	● 285-441	25	● 285-169	25	● 285-1178	25
	Block-to-block connector; for 50 mm <sup>2</sup> high-current terminal blocks			● 285-448	25				
	Block-to-block connector; for 95 mm <sup>2</sup> high-current terminal blocks					● 285-168	25		
	Block-to-block connector; for 185 mm <sup>2</sup> high-current terminal blocks							● 285-1179	25
	Three-phase set; with high-current terminal blocks; for DIN 35 x 15 rail	285-139	1	285-159	1	285-199	1	285-1169	1
	Three-phase set; with high-current terminal blocks; with mounting flanges			285-148	1	285-188	1	285-1165	1
	DIN-rail; per EN 60715; 35 x 15 mm; 2.3 mm thick; 2 m long								
	Steel	210-118	10						
	Copper			210-198	10	210-198	10	210-198	10
	Screwless end stop; for DIN-35 rail;								
	10 mm wide; I <sub>N</sub> 125 A	○ 249-117	25						
	14 mm wide; I <sub>N</sub> 309 A			○ 249-197	10	○ 249-197	10	○ 249-197	10
	Marker carrier; for POWER CAGE CLAMP 35/50/95 mm <sup>2</sup> ; 10.4 mm wide	○ 285-442	25	○ 285-442	25	○ 285-442	25		
	Operating tool with a partially insulated shaft; Type 3; (5.5 x 0.8) mm blade	● 210-721	1						
	T-wrench with a partially insulated shaft; with anti-reverse mating protection			● 285-173	1	● 285-173	1	● 285-173	1
	T-wrench with a partially insulated shaft			● 285-172	1	● 285-172	1	● 285-172	1

1



WAGO's spring pressure connection technology is a safety advantage, especially with large conductor cross-sections and currents.



Secure the terminal block to a mounting plate using two M8 cylinder-head screws and appropriate washers.

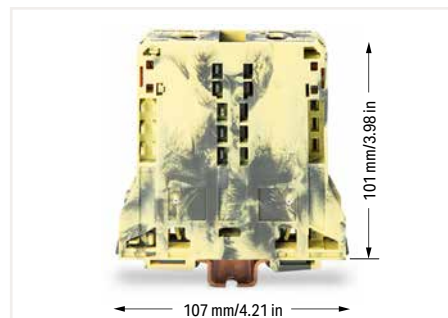

2-conductor through terminal block, dark gray/yellow (285-191), for ground connection without contact to the DIN-rail

# WAGO Double-Deck Terminal Block TOPJOB® S – 2000 / 2002 Series

## 1 (1,5) / 2,5 (4) mm<sup>2</sup>

1

Image	Description	Color/ Potentials	With Marker Carrier Item No.	Without Marker Carrier Item No.	PU	Electrical Data
<b>Double-deck terminal block; 1 (1.5) mm<sup>2</sup>; 2000 Series</b>						
	Double-deck terminal block; through/through terminal block	○ L/L	2000-2231	2000-2201	50	500 V/6 kV/3 ①; I <sub>N</sub> 13,5 A (16 A); 600 V, 20 A ②
		○ N/L	2000-2232	2000-2202	50	
		○ L/N	2000-2233	2000-2203	50	
		● N/N	2000-2234	2000-2204	50	
	Double-deck terminal block; Ground/through terminal block	○ GND/N	2000-2247	2000-2217	50	500 V/6 kV/3 ①; I <sub>N</sub> 13,5 A (16 A); 600 V, 20 A ②
		○ GND/L	2000-2257	2000-2227	50	
		○ Shield/N	2000-2248	2000-2218	50	
		○ Shield/L	2000-2258	2000-2228	50	
	Double-deck terminal block; 4-conductor through terminal block; internally commoned; violet conductor entry	○ L	2000-2238	2000-2208	50	500 V/6 kV/3 ①; I <sub>N</sub> 13,5 A (16 A); 600 V, 20 A ②
		● N	2000-2239	2000-2209	50	
	Double-deck terminal block; 4-conductor ground terminal block; internally commoned	● GND	2000-2237	2000-2207	50	500 V/6 kV/3 ①; I <sub>N</sub> 13,5 A (16 A); 600 V, 20 A ②
<b>Double-deck terminal block; 2.5 (4) mm<sup>2</sup>; 2002 Series ①</b>						
	Double-deck terminal block; through/through terminal block	○ L/L	2002-2231 ③	2002-2201 ③	50	500 V/6 kV/3 ②; I <sub>N</sub> 24 A (28 A); 600 V, 20 A ②; ③; 600 V, 20 A ④
		○ N/L	2002-2232 ③	2002-2202 ③	50	
		○ L/N	2002-2233 ③	2002-2203 ③	50	
		● N/N	2002-2234 ③,④	2002-2204 ③,④	50	
	Double-deck terminal block; Ground/through terminal block	○ GND/N	2002-2247 ③	2002-2217 ③	50	500 V/6 kV/3 ②; I <sub>N</sub> 24 A (28 A); 600 V, 20 A ②; ③; 600 V, 20 A ④
		○ GND/L	2002-2257 ③	2002-2227 ③	50	
		○ Shield/N	2002-2248	2002-2218	50	
		○ Shield/L	2002-2258	2002-2228	50	
	Double-deck terminal block; 4-conductor through terminal block; internally commoned; violet conductor entry	○ L	2002-2238 ③	2002-2208 ③	50	500 V/6 kV/3 ②; I <sub>N</sub> 24 A (28 A); 600 V, 20 A ②; ③; 600 V, 20 A ④
		● N	2002-2239 ③,④	2002-2209 ③,④	50	
	Double-deck terminal block; 4-conductor ground terminal block; internally commoned	● GND	2002-2237 ③	2002-2207 ③	50	500 V/6 kV/3 ②; I <sub>N</sub> 24 A (28 A); 600 V, 20 A ②; ③; 600 V, 20 A ④
	End and intermediate plate; 0.7 mm thick	● orange	2002-2292	2002-2292	25	These end plates also fit the 2000 Series Double-Deck Terminal Blocks!
	End and intermediate plate; 0.7 mm thick	○ gray	2002-2291	2002-2291	25	
<b>Double-deck terminal block; same profile as double-deck disconnect terminal block; 2.5 (4) mm<sup>2</sup>; 2002 Series ②</b>						
	Double-deck terminal block; through/through terminal block	○ L/L		2002-2601 ③	50	500 V/6 kV/3 ②; I <sub>N</sub> 24 A (28 A); 300 V, 20 A ②; ③; 300 V, 20 A ④
		○ N/L		2002-2602 ③	50	
		○ L/N		2002-2603 ③	50	
		● N/N		2002-2604 ③,④	50	
	Double-deck terminal block; Ground/through terminal block	○ GND/N		2002-2647 ③	50	500 V/6 kV/3 ②; I <sub>N</sub> 24 A (28 A); 300 V, 20 A ②; ③;
		○ GND/L		2002-2657 ③	50	
	End and intermediate plate; 1 mm thick	● orange		2002-2692	25	
	End and intermediate plate; 1 mm thick	○ gray		2002-2691	25	

<b>2000 Series</b>		
Conductor range: 0.14 ... 1.5 mm <sup>2</sup> "s+f-st"; Push-in termination: 1 ... 4 mm <sup>2</sup> "s" and 1 ... 2.5 mm <sup>2</sup> "insulated ferrules; 12 mm"; 22 ... 14 AWG; Strip length: 9 ... 11 mm / 0.35 ... 0.43 inch	Dimensions (W x H x D): 3.5 x 51.7 x 69.7 mm / 0.138 x 2.04 x 2.74 inch Versions for 800 V versions with suffix item no. xxx/099-000	① 500 V = rated voltage; 6 kV = rated impulse voltage; 3 = pollution degree
<b>2002 Series</b>		
Conductor range: 0.25 ... 4 mm <sup>2</sup> "s+f-st"; Push-in termination: 1 ... 4 mm <sup>2</sup> "s" and 1 ... 2.5 mm <sup>2</sup> "insulated ferrules; 12 mm"; 22 ... 14 AWG; Strip length: 10 ... 12 mm / 0.39 ... 0.47 inch	① Dimensions (W x H x D): 5.2 x 51.7 x 69.7 mm / 0.205 x 2.04 x 2.74 inch ② Dimensions (W x H x D): 5.2 x 51.7 x 93 mm / 0.205 x 2.04 x 3.66 inch Versions for 800 V versions with suffix item no. xxx/099-000	② 500 V = rated voltage; 6 kV = rated impulse voltage; 3 = pollution degree ③ Suitable for Ex e II applications; 440 V; 20 A ④ Suitable for Ex i applications
Accessories: see pages 36 ... 38.	Marking: WMB/WMB Inline/Marking strips	Suitable operating tool: see page 39

# Double-Deck Terminal Block TOPJOB® S; With Vertical Conductor Entry – 2002 / 2202 Series; 4-Conductor Double-Deck Terminal Block – 2002 Series 2.5 (4) mm<sup>2</sup>

Image	Description	Color/ Potentials	With Push-Button Item No.	Without Push-Button Item No.	PU	Electrical Data
<b>Double-deck terminal block; with vertical conductor entry</b>						
	Double-deck terminal block; through/through terminal block	<input type="radio"/> L/L	2202-2701	2002-2701 ②	50	800 V/8 kV/3 ①; I <sub>N</sub> 24 A (28 A)
		<input type="radio"/> N/L	2202-2702	2002-2702 ②	50	
		<input type="radio"/> L/N	2202-2703	2002-2703 ②	50	
		<input checked="" type="radio"/> N/N	2202-2704 ③	2002-2704 ②③	50	
	Double-deck terminal block; Ground/through terminal block	<input type="radio"/> GND/N	2202-2717	2002-2717 ②	50	800 V/8 kV/3 ①; I <sub>N</sub> 24 A (28 A)
		<input type="radio"/> GND/L	2202-2727	2002-2727 ②	50	
	Double-deck terminal block; 4-conductor through terminal block; internally commoned; violet conductor entry	<input type="radio"/> L	2202-2708	2002-2708 ②	50	800 V/8 kV/3 ①; I <sub>N</sub> 24 A (28 A)
		<input checked="" type="radio"/> N	2202-2709 ③	2002-2709 ②③	50	
	Double-deck terminal block; 4-conductor ground terminal block; internally commoned	<input checked="" type="radio"/> GND	2202-2707	2002-2707	50	800 V/8 kV/3 ①; I <sub>N</sub> 24 A (28 A)
		<input checked="" type="radio"/> GND		2002-2707/999-950 ②	50	
	End and intermediate plate; 0.8 mm thick	<input checked="" type="radio"/> orange	2002-2792	2002-2792	25	
	End and intermediate plate; 0.8 mm thick	<input type="radio"/> gray	2002-2791	2002-2791	25	

Image	Description	Color/ Potentials	With Marker Carrier Item No.	Without Marker Carrier Item No.	PU	Electrical Data
<b>4-conductor double-deck terminal block ①</b>						
	4-conductor double-deck terminal block; Through/through terminal block	<input type="radio"/> L/L	2002-2431 ②	2002-2401 ②	50	800 V/8 kV/3 ①; I <sub>N</sub> 24 A (28 A); 600 V, 20 A ②; 600 V, 20 A ③
		<input type="radio"/> N/L	2002-2432 ②	2002-2402 ②	50	
		<input type="radio"/> L/N	2002-2433 ②	2002-2403 ②	50	
		<input checked="" type="radio"/> N/N	2002-2434 ②③	2002-2404 ②③	50	
	4-conductor double-deck terminal block; Ground/through terminal block	<input type="radio"/> GND/N	2002-2447 ②	2002-2417 ②	50	800 V/8 kV/3 ①; I <sub>N</sub> 24 A (28 A); 600 V, 20 A ②; 600 V, 20 A ③
		<input type="radio"/> GND/L	2002-2457 ②	2002-2427 ②	50	
	4-conductor double-deck terminal block; Shield/through terminal block	<input type="radio"/> Shield/N	2002-2448	2002-2418	50	800 V/8 kV/3 ①; I <sub>N</sub> 24 A (28 A); 600 V, 20 A ②; 600 V, 20 A ③
		<input type="radio"/> Shield/L	2002-2458	2002-2428	50	
	4-conductor double-deck terminal block; 8-conductor through terminal block; internally commoned; violet conductor entry	<input type="radio"/> gray ④	2002-2438 ②	2002-2408 ②	50	800 V/8 kV/3 ①; I <sub>N</sub> 24 A (28 A); 600 V, 20 A ②; 600 V, 20 A ③
		<input checked="" type="radio"/> blue ⑤	2002-2439 ②③	2002-2409 ②③	50	
	4-conductor double-deck terminal block; 8-conductor ground terminal block	<input checked="" type="radio"/> green-yellow ⑥	2002-2437 ②	2002-2407 ②	50	800 V/8 kV/3 ①; I <sub>N</sub> 24 A (28 A); 600 V, 20 A ②; 600 V, 20 A ③
		<input type="radio"/> gray				
	End and intermediate plate; 0.8 mm thick	<input checked="" type="radio"/> orange	2002-2492	2002-2492	25	
	End and intermediate plate; 0.8 mm thick	<input type="radio"/> gray	2002-2491	2002-2491	25	

<b>4-conductor double-deck terminal block; same profile as double-deck disconnect terminal block ②</b>						
	4-conductor double-deck terminal block; Through/through terminal block; internally commoned; violet conductor entry	<input type="radio"/> L/L		2002-2608 ③	50	500 V/6 kV/3 ②; I <sub>N</sub> 24 A (28 A); 300 V, 20 A ②; 300 V, 20 A ③
		<input checked="" type="radio"/> N/N		2002-2604 ③④	50	
	4-conductor double-deck terminal block; Ground terminal block; internally commoned	<input type="radio"/> GND/N		2002-2607 ⑤	50	500 V/6 kV/3 ②; I <sub>N</sub> 24 A (28 A); 300 V, 20 A ②; 300 V, 20 A ③
	End and intermediate plate; 1 mm thick	<input checked="" type="radio"/> orange		2002-2692	25	
	End and intermediate plate; 1 mm thick	<input type="radio"/> gray		2002-2691	25	

<b>Double-deck terminal block; with vertical conductor entry</b>						
Conductor range: 0.25 ... 4 mm <sup>2</sup> "s+f-st"; Push-in termination: 1 ... 4 mm <sup>2</sup> "s" and 1 ... 2.5 mm <sup>2</sup> "insulated ferrules; 12 mm"; 22 ... 12 AWG; Strip length: 10 ... 12 mm / 0.39 ... 0.47 inch	Dimensions (W x H x D): 5.2 x 51.7 x 92.5 mm / 0.205 x 2.04 x 3.64 inch	① 800 V = rated voltage; 8 kV = rated impulse voltage; 3 = pollution degree ② Suitable for Ex e II applications; 550 V; 21 A ③ Suitable for Ex i applications				
<b>4-conductor double-deck terminal block</b>						
Conductor range: 0.25 ... 4 mm <sup>2</sup> "s+f-st"; Push-in termination: 1 ... 4 mm <sup>2</sup> "s" and 1 ... 2.5 mm <sup>2</sup> "insulated ferrules; 12 mm"; 22 ... 12 AWG; Strip length: 10 ... 12 mm / 0.39 ... 0.47 inch	① Dimensions (W x H x D): 5.2 x 52.1 x 105.1 mm / 0.205 x 2.05 x 4.14 inch ② Dimensions (W x H x D): 5.2 x 51.7 x 93 mm / 0.205 x 2.04 x 3.66 inch	① 800 V = rated voltage; 8 kV = rated impulse voltage; 3 = pollution degree ② Suitable for Ex e II applications; 550 V; 21 A ③ Suitable for Ex i applications				

# WAGO Triple-/Quadruple-Deck Rail-Mount Terminal Block TOPJOB® S – 2002 Series

## 2.5 (4) mm<sup>2</sup>

1

Image	Description	Color/ Potentials	With Marker Carrier Item No.	Without Marker Carrier Item No.	PU	Electrical Data
<b>Triple-deck terminal block</b>						
	Triple-deck terminal block; Through/through/through terminal block	<input type="radio"/> L/L/L	2002-3231 ②	2002-3201 ②	50	500 V/6 kV/3 ①; I <sub>n</sub> 24 A (28 A); 600 V, 20 A ②③; 600 V, 20 A ④
		<input type="radio"/> L/L/N	2002-3233 ②	2002-3203 ②	50	
		<input checked="" type="radio"/> N/N/N	2002-3234 ②③	2002-3204 ②③	50	
	Triple-deck terminal block; Ground conductor/through/through terminal block	<input type="radio"/> GND/N/L	2002-3247 ②	2002-3217 ②	50	500 V/6 kV/3 ①; I <sub>n</sub> 24 A (28 A); 600 V, 20 A ②③; 600 V, 20 A ④
		<input type="radio"/> GND/L/L	2002-3257 ②	2002-3227 ②	50	
	Triple-deck terminal block; Shield conductor/through/through terminal block	<input type="radio"/> Shield/N/L	2002-3248	2002-3218	50	
		<input type="radio"/> Shield/L/L	2002-3258	2002-3228	50	
	Double-deck terminal block; 6-conductor through terminal block; internally commoned; violet conductor entry	<input type="radio"/> L	2002-3238 ②	2002-3208 ②	50	500 V/6 kV/3 ①; I <sub>n</sub> 24 A (28 A); 600 V, 20 A ②③; 600 V, 20 A ④
		<input checked="" type="radio"/> N	2002-3239 ②③	2002-3209 ②③	50	
	Double-deck terminal block; 6-conductor ground terminal block; internally commoned	<input checked="" type="radio"/> GND	2002-3237 ②	2002-3207 ②	50	500 V/6 kV/3 ①; I <sub>n</sub> 24 A (28 A); 600 V, 20 A ②③; 600 V, 20 A ④
		<input type="radio"/> orange	2002-3292	2002-3292	25	
	End and intermediate plate; 0.8 mm thick	<input checked="" type="radio"/> orange	2002-3292	2002-3292	25	
		<input type="radio"/> gray	2002-3291	2002-3291	25	
<b>Quadruple-deck rail-mount terminal block</b>						
	Quadruple-deck rail-mount terminal block; Rail-mount terminal block for electric motor wiring	<input type="radio"/> L1/L2/L3/ GND	2002-4157 ②	2002-4127 ②	25	800 V/8 kV/3 ①; I <sub>n</sub> 20 A (25 A);
	Quadruple-deck rail-mount terminal block; Rail-mount terminal block for electric motor wiring	<input type="radio"/> L1/L2	2002-4141 ②	2002-4111 ②	25	
	Quadruple-deck rail-mount terminal block; Rail-mount terminal block for electric motor wiring	<input type="radio"/> L1/L2/L3	2002-4131 ②	2002-4101 ②	25	
	End and intermediate plate; 1 mm thick	<input checked="" type="radio"/> orange	2002-4192	2002-4192	25	
		<input type="radio"/> gray	2002-4191	2002-4191	25	

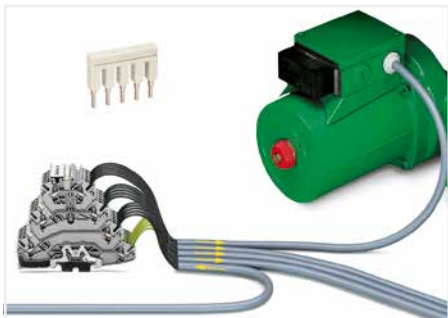

In addition to rail-mount terminal blocks for electric motor wiring, special versions are also available.

- Version without ground contact and only two potentials: These terminal blocks were custom designed to support additional functions, such as engine brakes or temperature sensors. Sharing a common profile, this terminal block version can be put next to the appropriate electric motor wiring terminal block without using intermediate plates.
- Version without ground contact and with three potentials: When using devices with protective insulation, for example, there are no open ground clamping units that could create confusion.

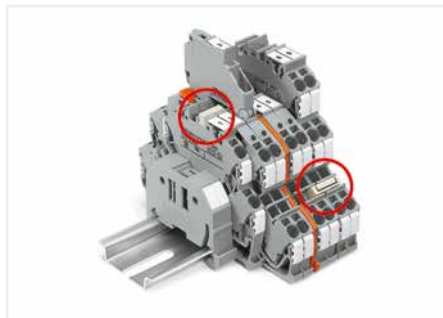

The same profile allows for commoning with double-deck terminal blocks (upper deck) and with triple-deck terminal blocks (lower deck).

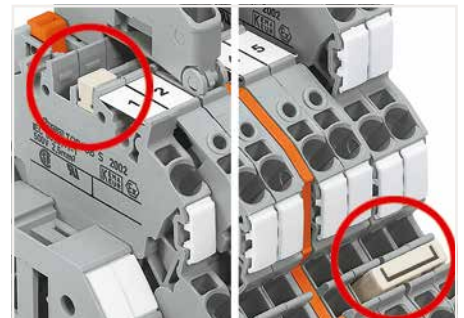

Left picture – Vertical jumper (2002-492)  
Right picture – Push-in type jumper bar (2002 Series)

Conductor range: 0.25 ... 4 mm<sup>2</sup> "s+f-st"; Push-in termination:  
1 ... 4 mm<sup>2</sup> "s" and 1 ... 2.5 mm<sup>2</sup> "insulated ferrules;  
12 mm"; 22 ... 12 AWG;  
Strip length: 10 ... 12 mm / 0.39 ... 0.47 inch

Accessories: see pages 36 ... 38.

Triple-deck terminal block dimensions (W x H x D):  
5.2 x 69.5 x 93.3 mm / 0.205 x 2.74 x 3.67 inch

Quadruple-deck terminal block dimensions (W x H x D):  
5.2 x 83.9 x 103.5 mm / 0.205 x 3.3 x 4.08 inch

Marking: WMB/WMB Inline/Marking strips

① 500/800 V = rated voltage;  
6/8 kV = rated impulse voltage;  
3 = pollution degree

② Suitable for Ex e II applications; 440 V; 19 A

③ Suitable for Ex i applications

Suitable operating tool: see page 39

## Series-Specific Accessories for WAGO Rail-Mount Terminal Blocks TOPJOB® S Operation

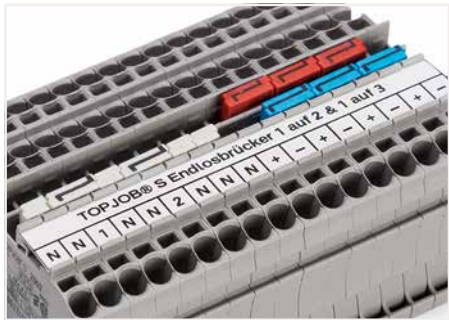

The 1-to-3 adjacent jumper for continuous commoning enables every other terminal block to be commoned. For example, positive and negative potentials can be accommodated alongside each other.

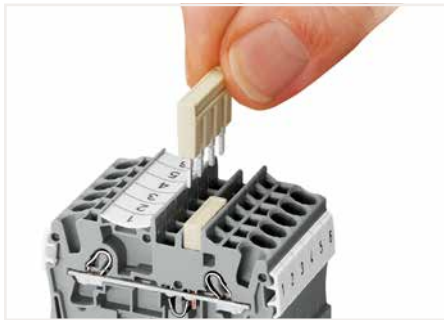

Insert a push-in type jumper bar and push down until it hits the backstop.

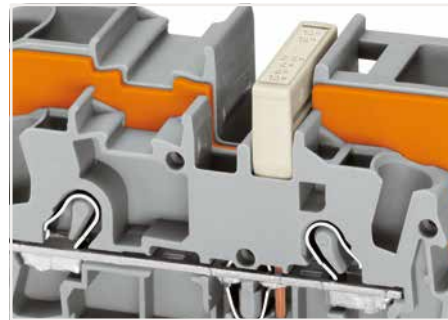

Commoning with step-down jumpers.

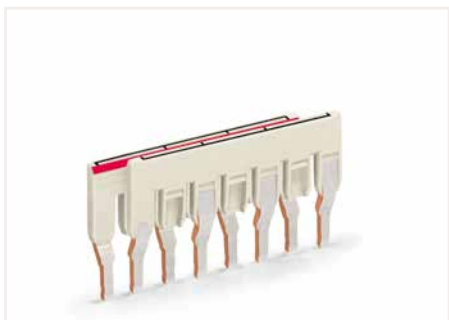

**Staggering jumpers in a single jumper slot.**  
Custom staggered jumpers can be created, e.g., for bridging over a terminal block with a different potential. Make sure that only one contact lug is in contact with the terminal block.



Orient the staggered jumpers' red stripes on the inside. Insert the staggered jumper and push down until it hits the backstop.



Push-in type wire jumpers common terminal blocks over longer distances and across multiple levels.

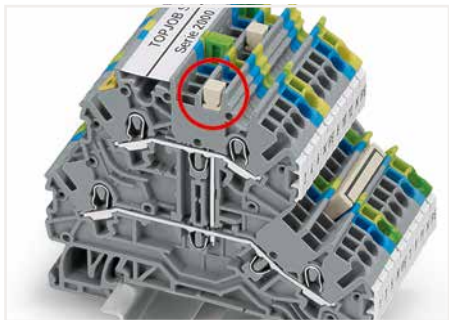

Commoning two levels via double-deck vertical jumper (2000-492).

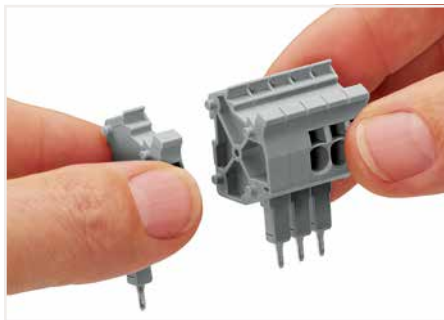

Snapping connectors and spacers together to assemble a multipole connector.



Testing tap (2009-182) for tool-free connection of test cables up to 2.5 mm<sup>2</sup> (12 AWG) – compatible with 2000 to 2016 Series

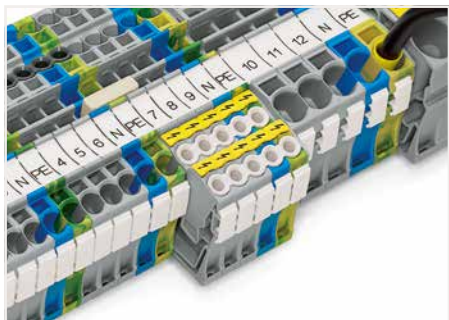

Insulation stops reliably prevent the insulation of thin conductors from being clamped. Protective warning covers identify terminal blocks that carry voltage even when the main switch is open.

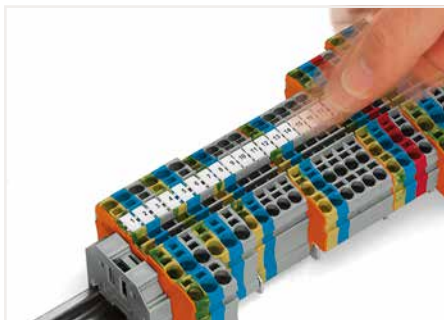

Snapping a marking strip into the marker slot.

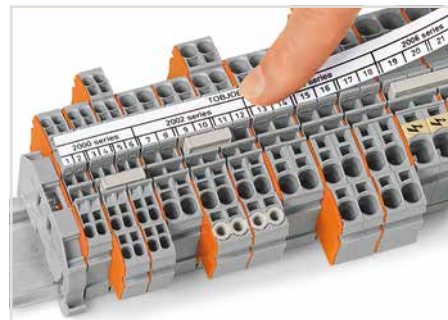

































Snapping a marking strip into a marker slot.

# Series-Specific Accessories for WAGO Rail-Mount Terminal Blocks TOPJOB® S Selection Guide



1

Image	Description	Series: 2000 / 2200 / 2020	PU	Series: 2001 / 2201	PU
	Adjacent jumper for continuous commoning; insulated; 2-way				
	Adjacent jumper for continuous commoning; insulated; 5-way				
	Adjacent jumper for continuous commoning; insulated; 1 to 3				
	Push-in type jumper bar; insulated; 2-way	<input type="radio"/> 2000-402	25	<input type="radio"/> 2001-402	25
	Push-in type jumper bar; insulated; 3-way	<input type="radio"/> 2000-403	25	<input type="radio"/> 2001-403	25
	Push-in type jumper bar; insulated; 4-way	<input type="radio"/> 2000-404	25	<input type="radio"/> 2001-404	25
	Push-in type jumper bar; insulated; 5-way	<input type="radio"/> 2000-405	25	<input type="radio"/> 2001-405	25
	⋮	⋮		⋮	
	Push-in type jumper bar; insulated; 10-way	<input type="radio"/> 2000-410	25	<input type="radio"/> 2001-410	25
	Push-in type jumper bar; insulated; 1 to 3	<input type="radio"/> 2000-433	25	<input type="radio"/> 2001-433	25
	Push-in type jumper bar; insulated; 1 to 4	<input type="radio"/> 2000-434	25	<input type="radio"/> 2001-434	25
	Push-in type jumper bar; insulated; 1 to 5	<input type="radio"/> 2000-435	25	<input type="radio"/> 2001-435	25
	⋮	⋮		⋮	
	Push-in type jumper bar; insulated; 1 to 10	<input type="radio"/> 2000-440	25	<input type="radio"/> 2001-440	25
	Delta jumper; insulated; 1-2; 3-4; 5-6	<input type="radio"/> 2000-406/020-000	25	<input type="radio"/> 2001-406/020-000	25
	Star point jumper; insulated; 1-3-5	<input type="radio"/> 2000-405/011-000	25	<input type="radio"/> 2001-405/011-000	25
	Step-down jumper; insulated; commons 6/4 mm <sup>2</sup> to 4/2.5/1.5 mm <sup>2</sup>			<input type="radio"/> 2006-499	25
	Step-down jumper; insulated; commons 16/10 mm <sup>2</sup> to 10/6/4/2.5 mm <sup>2</sup>				
	Staggered jumper; insulated, 2-way				
	Staggered jumper; insulated, 3-way				
	⋮				
	Staggered jumper; insulated, 12-way				
	Double-deck vertical jumper; insulated	<input type="radio"/> 2000-492	25		
	Double-deck vertical jumper; insulated				
	Triple-deck vertical jumper; insulated				
	Modular connector; snaps together; for jumper contact slot	<input type="radio"/> 2000-510	25	<input type="radio"/> 2001-511	25
	Spacer module; snaps together; bridges commoned terminal blocks	<input type="radio"/> 2000-549	25	<input type="radio"/> 2001-549	25
	End plate; for modular connector; 1.5 mm thick	<input type="radio"/> 2002-541	25	<input type="radio"/> 2002-541	25
	Protective warning marker; with black high-voltage symbol; for 5 terminal blocks	<input checked="" type="radio"/> 2000-115	25	<input checked="" type="radio"/> 2001-115	25
	Insulation stop; 5 pcs/strip; 0.25 ... 0.5 mm <sup>2</sup>			<input type="radio"/> 2001-171	25
	Insulation stop; 5 pcs/strip; 0.75 ... 1 mm <sup>2</sup>				

Series: 2002 / 2102 / 2202	PU	Series: 2004 / 2104 / 2204	PU	Series: 2006 / 2106 / 2206	PU	Series: 2007	PU	Series: 2010 / 2110 / 2210	PU	Series: 2016 / 2116 / 2216	PU
<input type="radio"/> 2002-400	25										
<input type="radio"/> 2002-415	25										
<input type="radio"/> 2002-423  	25										
<input type="radio"/> 2002-402  	25	<input type="radio"/> 2004-402	25	<input type="radio"/> 2006-402	25	 282-432	10	<input type="radio"/> 2010-402	25	<input type="radio"/> 2016-402	25
<input type="radio"/> 2002-403  	25	<input type="radio"/> 2004-403	25	<input type="radio"/> 2006-403	25	 282-433	10	<input type="radio"/> 2010-403	25	<input type="radio"/> 2016-403	25
<input type="radio"/> 2002-404  	25	<input type="radio"/> 2004-404	25	<input type="radio"/> 2006-404	25	 282-434	10	<input type="radio"/> 2010-404	25	<input type="radio"/> 2016-404	25
<input type="radio"/> 2002-405  	25	<input type="radio"/> 2004-405	25	<input type="radio"/> 2006-405	25	 282-435	10	<input type="radio"/> 2010-405	25	<input type="radio"/> 2016-405	25
⋮		⋮				⋮					
<input type="radio"/> 2002-410  	25	<input type="radio"/> 2004-410	25			 282-440	10				
<input type="radio"/> 2002-433  	25	<input type="radio"/> 2004-433	25	<input type="radio"/> 2006-433	25			<input type="radio"/> 2010-433	25	<input type="radio"/> 2016-433	25
<input type="radio"/> 2002-434  	25	<input type="radio"/> 2004-434	25	<input type="radio"/> 2006-434	25			<input type="radio"/> 2010-434	25	<input type="radio"/> 2016-434	25
<input type="radio"/> 2002-435  	25	<input type="radio"/> 2004-435	25	<input type="radio"/> 2006-435	25			<input type="radio"/> 2010-435	25	<input type="radio"/> 2016-435	25
⋮		⋮									
<input type="radio"/> 2002-440  	25	<input type="radio"/> 2004-440	25								
<input type="radio"/> 2002-406/020-000	25	<input type="radio"/> 2004-406/020-000	25								
<input type="radio"/> 2002-405/011-000	25	<input type="radio"/> 2004-405/011-000	25	<input type="radio"/> 2006-405/011-000	25			<input type="radio"/> 2010-405/011-000	25	<input type="radio"/> 2016-405/011-000	25
<input type="radio"/> 2006-499	25	<input type="radio"/> 2006-499	25	<input type="radio"/> 2006-499	25			<input type="radio"/> 2016-499	25	<input type="radio"/> 2016-499	25
<input type="radio"/> 2002-472	25										
<input type="radio"/> 2002-473	25										
⋮											
<input type="radio"/> 2002-482	25										
<input type="radio"/> 2002-492	25										
 2002-492/000-012	25										
<input type="radio"/> 2002-493	25										
<input type="radio"/> 2002-511	25	<input type="radio"/> 2004-511	25	<input type="radio"/> 2006-511	25			<input type="radio"/> 2010-511	25	<input type="radio"/> 2016-511	25
<input type="radio"/> 2002-549	25	<input type="radio"/> 2004-549	25	<input type="radio"/> 2006-549	25			<input type="radio"/> 2010-549	25	<input type="radio"/> 2016-549	25
<input type="radio"/> 2002-541	25	<input type="radio"/> 2004-541	25								
 2002-115	25	 2004-115	25	 2006-115	25	 2006-115	25	 2010-115	25	 2016-115	25
<input type="radio"/> 2002-171	25	<input type="radio"/> 2004-171	25								
<input checked="" type="radio"/> 2002-172	25	<input checked="" type="radio"/> 2004-172	25								









I<sub>N</sub> = I<sub>n</sub> terminal block

2002-64x, 2001-1441, 2002-1441 have no jumper slots.

 Red color variation with appendix number .../000-005;  
 Blue color variation with appendix number .../000-006  
 Light green color variation with appendix number .../000-018

# General Accessories for WAGO Rail-Mount Terminal Blocks TOPJOB® S

1

Image	Description	Color	Item No.	PU		
	Push-in type wire jumper; insulated; 1.5 mm² conductor cross-section; I <sub>N</sub> 18 A					
	L = 60 mm	● black	2009-412	10		
	L = 110 mm	● black	2009-414	10		
		● red	2009-414/000-005	10		
	Banana plug; for 4 mm socket diameter; color mixed; 10 x orange, white, black, blue, yellow; max. 42 V	● blue	2009-414/000-006	10		
		● black	2009-416	10		
	Test plug adapter; for 4 mm Ø test plug	○ gray	2009-174	25		
	Testing tap; for max. 2.5 mm²	○ gray	2009-182	25		
	Test plug; with 500 mm cable; 2 mm Ø; max. 42 V	● red	210-136	50		
	Test plug; with 500 mm cable; 2.3 mm Ø; max. 42 V	● yellow	210-137	50		
	Step-down test plug; from 4mm socket to 2mm plug	● red	210-297	25		
	Marking strip; plain; for Smart Printer; 11 mm wide; 50 m reel	○ white	2009-110	1		
	WMB Inline; plain; for Smart Printer; 2,300 WMB markers (3.5 mm)/reel	○ white	2009-113	1		
	WMB Inline; plain; for Smart Printer; 2,000 WMB markers (4 mm)/reel; for 4 ... 4.2 mm terminal block width	○ white	2009-114	1		
	WMB Inline; plain; for Smart Printer; 1,500 WMB markers (5 mm)/reel; for 5 ... 5.2 mm terminal block width	○ white	2009-115	1		
	WMB marker card; 10 strips with 10 markers/card	Color	3,5 mm	4 ... 4,2 mm	5 ... 5,2 mm	
		○ white	793-3501	793-4501	793-5501	5
		● yellow		793-4501/000-002	793-5501/000-002	5
		● red		793-4501/000-005	793-5501/000-005	5
		● blue		793-4501/000-006	793-5501/000-006	5
		○ gray		793-4501/000-007	793-5501/000-007	5
		● orange		793-4501/000-012	793-5501/000-012	5
		● light green		793-4501/000-017	793-5501/000-017	5
		● green		793-4501/000-023	793-5501/000-023	5
		● violet		793-4501/000-024	793-5501/000-024	5



Testing via banana plug. Picture shows a test plug adapter (209-170).

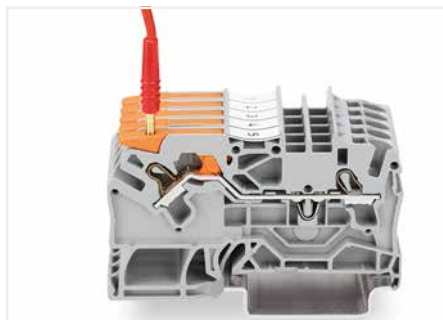

Testing with a 2 mm Ø test plug (max. 42 V).



Snapping a marking strip into the marker slot.



# General Accessories for WAGO Rail-Mount Terminal Blocks TOPJOB® S and WAGO High-Current Terminals Blocks

1

Image	Description	Color	Item No.	PU
	Operating tool with a partially insulated shaft; Type 1; (2.5 x 0.4) mm blade	● green	210-719	1
	Operating tool with a partially insulated shaft; Type 2; (3.5 x 0.5) mm blade	● green	210-720	1
	Operating tool with a partially insulated shaft; Type 3; (5.5 x 0.8) mm blade	● green	210-721	1
	Operating tool set; with 210-719/-720/-721	● green	210-722	1
	Operating tool; 3.5 and 2.5 mm blades	● green	2009-309	1
	Operating tool; 3.5 and 5.5 mm blades	● green	2009-310	1
	Cable cutter; for copper and aluminum cables up to 35 mm² (2 AWG)	● green	206-118	1
	„Variocrimp 4“ crimping tool; crimping range: 0.25 ... 4 mm² (24 ... 12 AWG)	● green	206-1204	1
	„Variocrimp 16“ crimping tool; 6 mm² (10 AWG), 10 mm² (8 AWG) and 16 mm² (6 AWG)	● green	206-1216	1
	„Variocrimp 25“ Crimping tool; crimping range: 10 mm² (8 AWG), 16 mm² (6 AWG) and 25 mm² (4 AWG)	● green	206-1225	1
	„Variocrimp 50“ Crimping tool; crimping range: 35 mm² (2 AWG) and 50 mm² (1/0 AWG)	● green	206-1250	1

**Ferrule; insulated; electro-tin-plated; electrolytic copper; gastight crimped; per DIN 46288 (Part 4/09.09)**

Image	Conductor Cross-Section	Color	Strip Length	L	L 1	D	D 1	D 2	Item No.	PU
	0.5 mm² / 20 AWG	○ white	12 mm / 0.47 inch	16	10	3,1	2,6	1	216-241	1000
	0.75 mm² / 18 AWG	○ gray	12 mm / 0.47 inch	16	10	3,3	2,8	1,2	216-242	1000
	0.75 mm² / 18 AWG	○ gray	14 mm / 0.55 inch	18	12	3,3	2,8	1,2	216-262	1000
	1 mm² / 18 AWG	● red	12 mm / 0.47 inch	16	10	3,5	3	1,4	216-243	1000
	1 mm² / 18 AWG	● red	14 mm / 0.55 inch	18	12	3,5	3	1,4	216-263	1000
	1.5 mm² / 16 AWG	● black	12 mm / 0.47 inch	16	10	4	3,5	1,7	216-244	1000
	1.5 mm² / 16 AWG	● black	14 mm / 0.55 inch	18	12	4	3,5	1,7	216-264	1000
	1.5 mm² / 16 AWG	● black	20 mm / 0.79 inch	24	18	4	3,5	1,7	216-284	500
	2.5 mm² / 14 AWG	● blue	12 mm / 0.47 inch	17	10	4,7	4,2	2,2	216-246	1000
	2.5 mm² / 14 AWG	● blue	14 mm / 0.55 inch	19	12	4,7	4,2	2,2	216-266	1000
	2.5 mm² / 14 AWG	● blue	20 mm / 0.79 inch	25	18	4,7	4,2	2,2	216-286	500
	4 mm² / 12 AWG	○ gray	14 mm / 0.55 inch	20	12	5,4	4,8	2,8	216-267	500
	4 mm² / 12 AWG	○ gray	20 mm / 0.79 inch	26	18	5,4	4,8	2,8	216-287	100
	6 mm² / 10 AWG	● yellow	14 mm / 0.55 inch	20	12	6,9	6,3	3,5	216-208	100
	6 mm² / 10 AWG	● yellow	20 mm / 0.79 inch	26	18	6,9	6,3	3,5	216-288	100
	10 mm² / 8 AWG	● red	20 mm / 0.79 inch	28	18	8,4	7,6	4,5	216-289	100
	16 mm² / 6 AWG	● blue	23 mm / 0.91 inch	28	18	9,6	8,8	5,8	216-210	100

**Ferrule; uninsulated; electro-tin-plated; electrolytic copper; gastight crimped; per DIN 46288 (Part 4/09.09)**

	25 mm² / 4 AWG		25 mm / 0.98 inch	25		9,5		7,3	216-413	50
	35 mm² / 2 AWG		25 mm / 0.98 inch	25		11		8,3	216-414	50
	35 mm² / 2 AWG		30 mm / 1.18 inch	30		11		8,3	216-424	50
	50 mm² / 1/0 AWG		30 mm / 1.18 inch	30		13		10,3	216-425	50
	50 mm² / 1/0 AWG		35 mm / 1.38 inch	35		13		10,3	216-435	50



Insert the ferruled conductor into the crimping station.

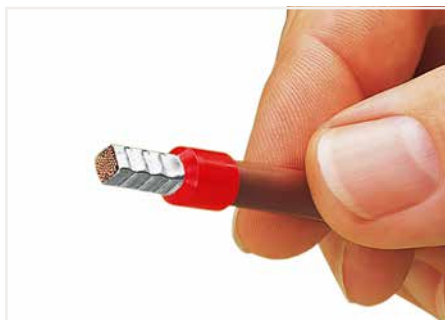

A perfect gas-tight crimp – both electrically and mechanically reliable

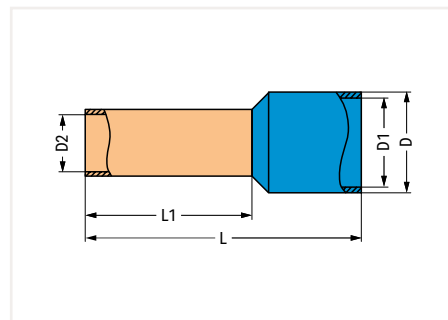

# WAGO Installation Rail-Mount Terminal Blocks TOPJOB® S Operation

1



Inserting a conductor via push-in termination. Solid conductors with cross-sections from either one size above, or up to two sizes below, the rated cross-section can be simply pushed in – no tools needed.

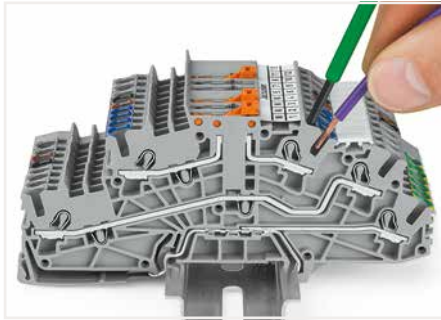

Inserting a conductor via operating tool. Connecting fine-stranded conductors without ferrules, or small cross-sectional conductors that cannot be pushed in, is performed similarly to the original CAGE CLAMP® – just use an operating tool.

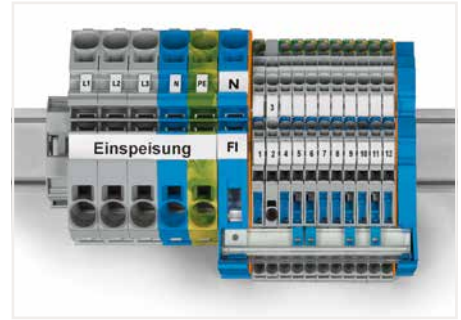

Mounting busbars on busbar carriers: Insert busbar ends onto large busbar carriers (2009-305) or onto supply terminal blocks with an integrated busbar carrier.

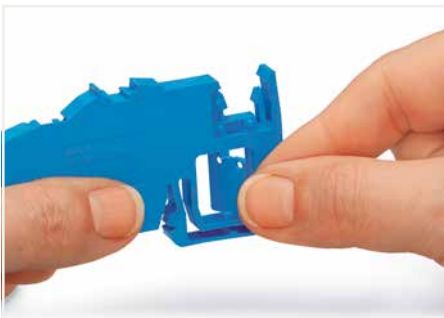

Removing the separator plate from the busbar carrier or from the N-disconnect terminal block.

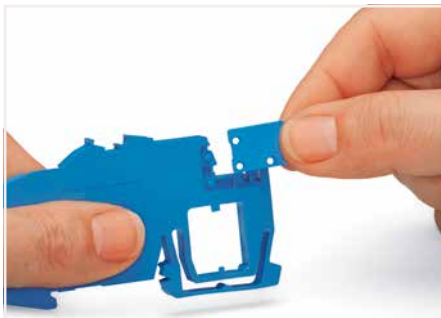

Inserting the separator plate into the busbar carrier to protect the N-busbar against accidental contact.

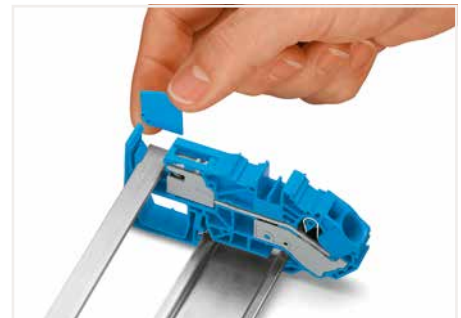

Inserting separator plate removed from N-disconnect terminal block.

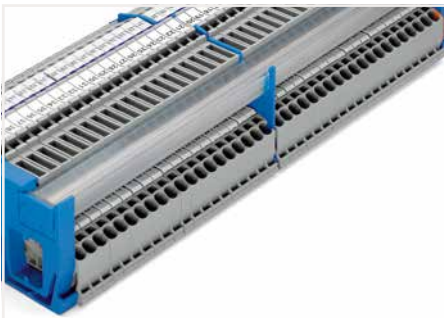

The compact busbar carrier (1.5 mm thick), which is placed every 200 mm, provides additional busbar support for longer assemblies.

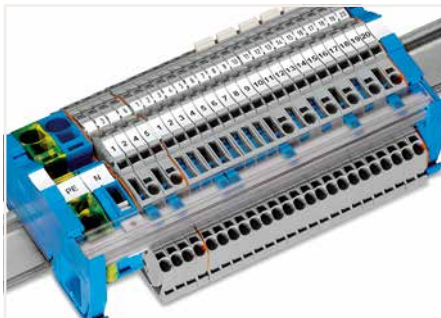

The busbar transparent cover (Item No. 777-303) protects the busbar against accidental contact and makes it easy to see which terminal blocks are connected to the busbar.



Tool-operated N-disconnect slide link

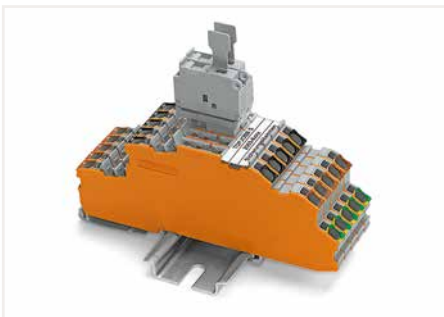

Multilevel installation terminal block as carrier terminal block for fuse or disconnect plugs, for more information, see Full Line Catalog, Volume 1

- 1 Conductor range: 0.25 ... 4 mm<sup>2</sup> "s+f-st"; Push-in termination: 1 ... 4 mm<sup>2</sup> "s" and 1 ... 2.5 mm<sup>2</sup> "insulated ferrules; 12 mm"; 22 ... 12 AWG; Strip length: 10 ... 12 mm / 0.39 ... 0.47 inch
  - 2 Conductor range: 0.5 ... 6 mm<sup>2</sup> "s+f-st"; Push-in termination: 1.5 ... 6 mm<sup>2</sup> "s" and 1.5 ... 4 mm<sup>2</sup> "insulated ferrules; 12 mm"; 22 ... 12 AWG; Strip length: 11 ... 13 mm / 0.43 ... 0.51 inch
- Accessories: see pages 36 ... 38.

- 3 Potential – Ground  
250 V = rated voltage;  
4 kV = rated impulse voltage;  
3 = pollution degree

- 4 Potential – Potential  
400 V = rated voltage;  
6 kV = rated impulse voltage;  
3 = pollution degree

Marking: WMB/WMB Inline/Marking strips

- 5 Conductor range: 0.5 ... 16 mm<sup>2</sup> "s+f-st", 25 mm<sup>2</sup> "f-st"; Push-in termination: 6 ... 16 mm<sup>2</sup> "s" and 6 ... 16 mm<sup>2</sup> "insulated ferrules; 18 mm"; 20 ... 4 AWG; Strip length: 18 ... 20 mm / 0.71 ... 0.79 inch

- 6 250/800 V = rated voltage;  
4/8 kV = rated impulse voltage;  
3 = pollution degree

Suitable operating tool: see page 39

# WAGO Multilevel Installation Terminal Block TOPJOB® S; With Disconnect Slide Link/Knife Disconnect – 2003 Series; WAGO N-Disconnect Terminal Block and Power Distribution Disconnect Terminal Block TOPJOB® S – 2016 Series

## 2.5 (4) / 16 mm<sup>2</sup>

1

Image	Description	Color	With Disconnect Slide Link Item No.	I <sub>N</sub>	With Knife Disconnect Item No.	I <sub>N</sub>	PU	Potential Marking	Electrical Data
<b>Multilevel installation terminal block; 2.5 (4) mm<sup>2</sup>; 2003 Series ①</b>									
	Multilevel installation terminal block	○ gray	2003-7641	32 A	2003-6641	20 A	50	NT/L/GND	250 V/4 kV/3 ③; 400 V/6 kV/3 ④
	Multilevel installation terminal block	○ gray	2003-7640	32 A			50	NT/L	
	Multilevel installation terminal block	○ gray	2003-7659	32 A			50	LT/L	
	Multilevel installation terminal block	○ gray	2003-7646	32 A	2003-6646	24 A	50	N/L/GND	
	Multilevel installation terminal block	○ gray	2003-7645	32 A	2003-6645	24 A	50	L/L/GND	
	Multilevel installation terminal block	○ gray	2003-7642	32 A	2003-6642	24 A	50	L/L	400 V/6 kV/3 ④
	Multilevel installation terminal block	○ gray	2003-7649	32 A	2003-6649	24 A	50	N/L	
	Multilevel installation terminal block	○ gray	2003-7650	32 A	2003-6650	24 A	50	L	
	Multilevel installation terminal block	○ gray	2003-7651	32 A	2003-6651	24 A	50	N	
	End and intermediate plate; 0,8 mm thick	● orange	2003-7692				25		

Image	Description	Color	With Disconnect Slide Link Item No.	I <sub>N</sub>	With Knife Disconnect Item No.	I <sub>N</sub>	PU	Potential Marking	Electrical Data
<b>Multilevel installation terminal block; 4 (6) mm<sup>2</sup>; 2005 Series ②</b>									
	Multilevel installation terminal block; with N-disconnect slide link	○ gray	2005-7641	36 A			50	NT/L/GND	250 V/4 kV/3 ③; 400 V/6 kV/3 ④
	Multilevel installation terminal block	○ gray	2005-7646	36 A			50	N/L/GND	
	Multilevel installation terminal block	○ gray	2005-7645	36 A			50	L/L/GND	
	Multilevel installation terminal block	○ gray	2005-7642	36 A			50	L/L	400 V/6 kV/3 ④
	Multilevel installation terminal block	○ gray	2005-7649	36 A			50	N/L	
	End and intermediate plate; 1 mm thick	● orange	2005-7692				25		

Image	Description	Color	Item No.	PU	Dimensions (W x H x D)	Electrical Data
<b>N-disconnect terminal block and power distribution disconnect terminal block; 16 (25 "f-st") mm<sup>2</sup>; 2016 Series ⑤</b>						
	1-conductor N-disconnect terminal block	● blue	2016-7114	25	12 x 38,1 x 69,4 mm/	250 V/4 kV/3 ⑥; I <sub>N</sub> 65 A
	1-conductor power distribution disconnect terminal block	○ gray	2016-7111	25	0.472 x 1.5 x 2.73 inch	
	End and intermediate plate; 1 mm thick	● orange	2016-7192	25	1 x 38 x 69 mm/ 0.04 x 1.496 x 2.72 inch	
	1-conductor N-disconnect terminal block	● blue	2016-7714	20	12 x 40,8 x 99,7 mm/	250 V/4 kV/3 ⑥; I <sub>N</sub> 76 A
	1-conductor power distribution disconnect terminal block	○ gray	2016-7711	20	0.472 x 1,61 x 3,93 inch	
	End and intermediate plate; 1 mm thick	● orange	2016-7792	25	1 x 41,7 x 98,1 mm/ 0.04 x 1.642 x 3.93 inch	
<b>2-conductor supply terminal block for distribution boxes; 16 (25 "f-st") mm<sup>2</sup>; 2016 Series ⑤</b>						
	2-conductor supply terminal block for distribution boxes	○ gray	2016-7601	20	12 x 40,8 x 85,7 mm/ 0.472 x 1,61 x 3,37 inch	800 V/8 kV/3 ⑥; I <sub>N</sub> 76 A
	2-conductor supply terminal block for distribution boxes	● blue	2016-7604	20		
	2-conductor ground terminal block	● green-yellow	2016-7607	20		
	End and intermediate plate; 1 mm thick	● orange	2016-7692	25	1 x 41,7 x 84,5 mm/	
	End and intermediate plate; 1 mm thick	○ gray	2016-7691	25	0.04 x 1.642 x 3.33 inch	

# WAGO Disconnect/Test/Fuse Terminal Blocks TOPJOB® S Operation

1

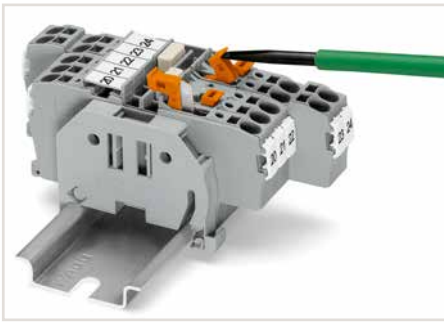

Disconnect/test terminal block with pivoting knife disconnect – Opening a knife disconnect.

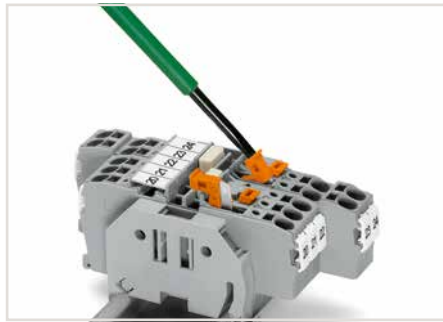

Disconnect/test terminal block with pivoting knife disconnect – Closing the knife disconnect.



Disconnect/test terminal block with pivoting knife disconnect – Testing with voltage tester.



Disconnect/test terminal block with pivoting knife disconnect and mechanical interlock – knife disconnect in open position

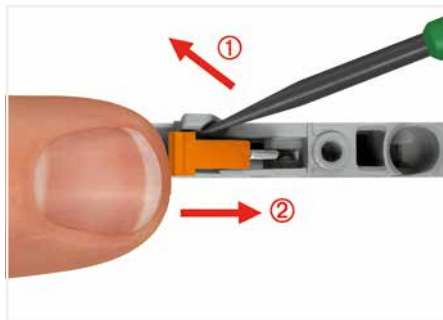

Disconnect/test terminal block with pivoting knife disconnect and mechanical interlock – Closing the knife disconnect.

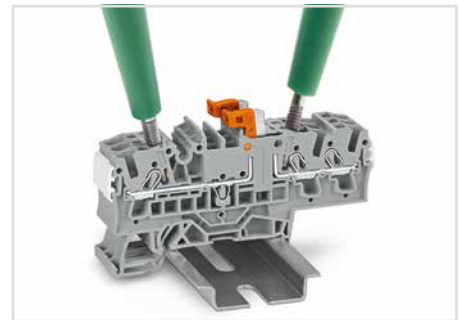

Disconnect/test terminal block with pivoting knife disconnect – Testing with voltage tester.

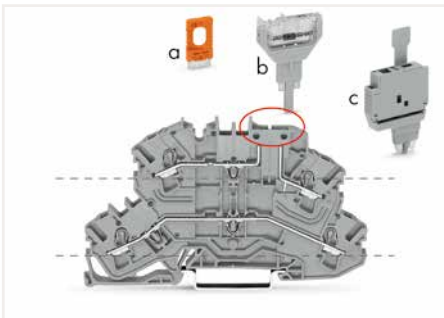

Carrier terminal blocks (2002-2661) have the same design as disconnect terminal blocks.

The following components may be used:

- Disconnect plugs (a: 2002-401)
- Pluggable diode (b: 2002-800/1000-411)
- LED module (2002-800/1000-541, no illustration)
- Fuse plug (c: 2004-911)

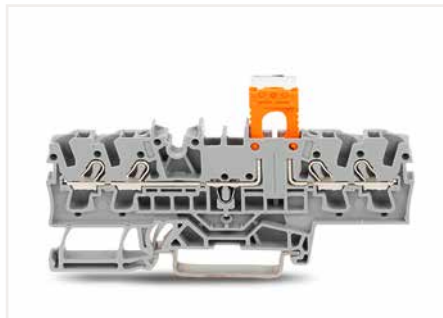

Carrier terminal block (2002-1861) with disconnect plug (2002-401) in parked position

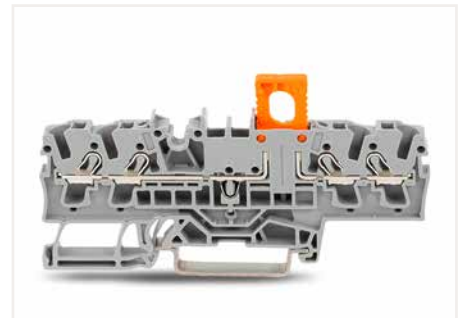

Carrier terminal block (2002-401) with disconnect plug (2002-1861) in operating position



Fused Disconnect Terminal Block with a Pivoting Fuse Holder  
Pivot the fuse holder into the locked open position.













Fused Disconnect Terminal Block with a Pivoting Fuse Holder  
Fuse replacement:



Fuse terminal blocks with a width of 6.2 mm can be assembled adjacently. If there is no adjacent fuse terminal block at the end of the assembly, an end plate must be used.

# WAGO Disconnect/Test Terminal Block; WAGO Through/Ground Terminal Block TOPJOB® S of Same Profile – 2002/2202 Series

## 2.5 (4) mm<sup>2</sup>

Image	Description	Color	With Push-Button Item No.	Without Push-Button Item No.	PU	Dimensions (W x H x D)	Electrical Data
<b>2-conductor disconnect/test/through terminal block</b>							
	2-conductor disconnect/test terminal block; with test point; orange disconnect link	gray ☹	2202-1671	2002-1671 ②	50	5,2 x 32,9 x 66,1 mm/ 0.205 x 1.3 x 2.6 inch	400 V/6 kV/3 ①; I <sub>N</sub> 16 A; 300 V, 15 A ②; 300 V, 10 A ③
		blue ☹	2202-1674	2002-1674 ②	50		
		orange ☹	2202-1672	2002-1672 ②	50		
	2-conductor through terminal block; with test point; same profile as 2-conductor disconnect terminal block	gray ☹	2202-1601	2002-1601 ②	50	5,2 x 32,9 x 66,1 mm/ 0.205 x 1.3 x 2.6 inch	400 V/6 kV/3 ①; I <sub>N</sub> 16 A; 300 V, 15 A ②; 300 V, 10 A ③
		blue ☹	2202-1604	2002-1604 ②	50		
		orange ☹	2202-1602	2002-1602 ②	50		
	2-conductor disconnect/test terminal block; with mechanical interlock; with test point; orange disconnect link	gray ☹		2002-1671/401-000 ②	50	5,2 x 32,9 x 66,1 mm/ 0.205 x 1.3 x 2.6 inch	400 V/6 kV/3 ①; I <sub>N</sub> 16 A; 300 V, 15 A ②;
		blue ☹		2002-1674/401-000 ②	50		
		orange ☹		2002-1672/401-000 ②	50		
	2-conductor carrier terminal block; with test point	gray	2202-1661	2002-1661	50	5,2 x 32,9 x 66,1 mm/ 0.205 x 1.3 x 2.6 inch	400 V/6 kV/3 ①; I <sub>N</sub> 16 A
	Disconnect plug for carrier terminal blocks; suitable when using a carrier terminal block as disconnect terminal block	orange		2002-401	25		I <sub>N</sub> 10 A
	End and intermediate plate; 1 mm thick	orange	2002-1692	2002-1692	25	1 x 30,4 x 66,1 mm/ 0.04 x 1.2 x 2.6 inch	
		gray	2002-1691	2002-1691	25		
	2-conductor disconnect/test terminal block; with test point; with additional jumper slot; orange disconnect link	gray ☹	2202-1971	2002-1971 ②	50	5,2 x 32,9 x 72,9 mm/ 0.205 x 1.3 x 2.87 inch	400 V/6 kV/3 ①; I <sub>N</sub> 16 A; 300 V, 15 A ②;
		blue ☹	2202-1974	2002-1974 ②	50		
		orange ☹	2202-1972	2002-1972 ②	50		
	2-conductor through terminal block; with test point; with additional jumper slot; same profile as 2-conductor disconnect terminal block	gray ☹	2202-1901	2002-1901 ②	50	5,2 x 32,9 x 72,9 mm/ 0.205 x 1.3 x 2.87 inch	400 V/6 kV/3 ①; I <sub>N</sub> 16 A; 300 V, 15 A ②; 300 V, 10 A ③
		blue ☹	2202-1904	2002-1904 ②	50		
		orange ☹	2202-1902	2002-1902 ②	50		
	2-conductor disconnect/test terminal block; with mechanical interlock; with test point; with additional jumper slot; orange disconnect link	gray ☹		2002-1971/401-000 ②	50	5,2 x 32,9 x 72,9 mm/ 0.205 x 1.3 x 2.87 inch	400 V/6 kV/3 ①; I <sub>N</sub> 16 A; 300 V, 15 A ②;
		blue ☹		2002-1974/401-000 ②	50		
		orange ☹		2002-1972/401-000 ②	50		
	2-conductor ground terminal block	green-yellow	2202-1907	2002-1907	50	5,2 x 32,9 x 76,8 mm/ 0.205 x 1.3 x 3.02 inch	400 V/6 kV/3 ①; I <sub>N</sub> 16 A
	End and intermediate plate; 1 mm thick	orange	2002-1992	2002-1992	25	1 x 32,9 x 72,9 mm/ 0.04 x 1.3 x 2.87 inch	
		gray	2002-1991	2002-1991	25		

Conductor range: 0.25 ... 4 mm<sup>2</sup> "s+f-st"; Push-in termination:  
1 ... 4 mm<sup>2</sup> "s" and 1 ... 2.5 mm<sup>2</sup> "insulated ferrules;  
12 mm"; 22 ... 12 AWG;  
Strip length: 10 ... 12 mm / 0.39 ... 0.47 inch

- ① 400 V = rated voltage  
6 kV = rated impulse voltage  
3 = pollution degree
- ② Suitable for Ex ec IIc applications

Accessories: see pages 36 ... 38.  
Marking: WMB/WMB Inline/Marking strips  
Suitable operating tool: see page 39

# WAGO Disconnect/Test Terminal Block; WAGO Through/Ground Terminal Block TOPJOB® S of Same Profile – 2002/2202 Series

## 2.5 (4) mm<sup>2</sup>









1

Image	Description	Color	With Push-Button Item No.	Without Push-Button Item No.	PU	Dimensions (W x H x D)	Electrical Data
<b>3-conductor disconnect/test/through/ground terminal block</b>							
	3-conductor disconnect/test terminal block; with test point; orange disconnect link	gray	2202-1771	2002-1771 ②	50	5,2 x 32,9 x 76,8 mm/ 0.205 x 1.3 x 3.02 inch	400 V/6 kV/3 ①; I <sub>N</sub> 16 A; 300 V, 15 A ②; 300 V, 10 A ③
		blue	2202-1774	2002-1774 ②	50		
		orange	2202-1772	2002-1772 ②	50		
	3-conductor through terminal block; with test point; same profile as 3-conductor disconnect terminal block	gray	2202-1701	2002-1701 ②	50	5,2 x 32,9 x 76,8 mm/ 0.205 x 1.3 x 3.02 inch	400 V/6 kV/3 ①; I <sub>N</sub> 16 A; 300 V, 15 A ②; 300 V, 10 A ③
		blue	2202-1704	2002-1704 ②	50		
		orange	2202-1702	2002-1702 ②	50		
	3-conductor disconnect/test terminal block; with mechanical interlock; with test point; orange disconnect link	gray		2002-1771/401-000 ②	50	5,2 x 32,9 x 76,8 mm/ 0.205 x 1.3 x 3.02 inch	400 V/6 kV/3 ①; I <sub>N</sub> 16 A; 300 V, 15 A ②
		blue		2002-1774/401-000 ②	50		
		orange		2002-1772/401-000 ②	50		
	3-conductor ground terminal block	green-yellow	2202-1707	2002-1707 ②	50	5,2 x 32,9 x 76,8 mm/ 0.205 x 1.3 x 3.02 inch	400 V/6 kV/3 ①; I <sub>N</sub> 16 A; 300 V, 15 A ②; 300 V, 10 A ③
	3-conductor carrier terminal block; with test point	gray	2202-1761	2002-1761	50	5,2 x 32,9 x 76,8 mm/ 0.205 x 1.3 x 3.02 inch	400 V/6 kV/3 ①; I <sub>N</sub> 16 A; 300 V, 15 A ②; 300 V, 10 A ③
	Disconnect plug for carrier terminal blocks; suitable when using a carrier terminal block as disconnect terminal block	orange		2002-401	25		I <sub>N</sub> 10 A
	End and intermediate plate; 1 mm thick	orange	2002-1792	2002-1792	25	1 x 32,9 x 76,8 mm/ 0.04 x 1.3 x 3.02 inch	
		gray	2002-1791	2002-1791	25		
<b>4-conductor disconnect/test/through terminal block</b>							
	4-conductor disconnect/test terminal block; with test point; orange disconnect link	gray	2202-1871	2002-1871 ②	50	5,2 x 32,9 x 87,5 mm/ 0.205 x 1.3 x 3.44 inch	400 V/6 kV/3 ①; I <sub>N</sub> 16 A; 300 V, 15 A ②; 300 V, 10 A ③
		blue	2202-1874	2002-1874 ②	50		
		orange	2202-1872	2002-1872 ②	50		
	4-conductor through terminal block; with test point; same profile as 4-conductor disconnect terminal block	gray	2202-1801	2002-1801 ②	50	5,2 x 32,9 x 87,5 mm/ 0.205 x 1.3 x 3.44 inch	400 V/6 kV/3 ①; I <sub>N</sub> 16 A; 300 V, 15 A ②; 300 V, 15 A ③
		blue	2202-1804	2002-1804 ②	50		
		orange	2202-1802	2002-1802 ②	50		
	4-conductor disconnect/test terminal block; with mechanical interlock; with test point; orange disconnect link	gray		2002-1871/401-000 ②	50	5,2 x 32,9 x 87,5 mm/ 0.205 x 1.3 x 3.44 inch	400 V/6 kV/3 ①; I <sub>N</sub> 16 A; 300 V, 15 A ②
		blue		2002-1874/401-000 ②	50		
		orange		2002-1872/401-000 ②	50		
	4-conductor carrier terminal block; with test point	gray	2202-1861	2002-1861	50	5,2 x 32,9 x 87,5 mm/ 0.205 x 1.3 x 3.44 inch	400 V/6 kV/3 ①; I <sub>N</sub> 16 A; 300 V, 15 A ②; 300 V, 10 A ③
	Disconnect plug for carrier terminal blocks; suitable when using a carrier terminal block as disconnect terminal block	orange		2002-401	25		I <sub>N</sub> 10 A
	End and intermediate plate; 1 mm thick	orange	2002-1892	2002-1892	25	1 x 32,9 x 87,5 mm/ 0.04 x 1.3 x 3.44 inch	
		gray	2002-1891	2002-1891	25		

# WAGO Fuse Terminal Block TOPJOB® S; for Mini-Automotive Blade-Style Fuses

## - 2002/2202 Series

2.5 (4) mm<sup>2</sup>

Image	Description	Color	With Push-Button Item No.	Without Push-Button Item No.	PU	Dimensions (W x H x D)	Electrical Data
<b>2-conductor fuse terminal block</b>							
	2-conductor fuse terminal block; with test point	gray ⑤	2202-1681	2002-1681 ②	50	5,2 x 32,9 x 66,1/ 0.205 x 1.3 x 2.6 inch	400 V/6 kV/3 ①; I <sub>n</sub> 10 A; 300 V, 10 A ③; 300 V, 10 A ④
	End and intermediate plate; 1 mm thick	orange gray	2002-1692 2002-1691	2002-1692 2002-1691	25 25	1 x 30,4 x 66,1/ 0.04 x 1.2 x 2.6 inch	
<b>2-conductor fuse terminal block with LED</b>							
	2-conductor fuse terminal block; with test point; with blown fuse indication by LED; LED power consumption: 4.8 mA						400 V/6 kV/3 ①; I <sub>n</sub> 10 A
	12 V; Circuit 1 ③	gray ⑤	2202-1981/1000-429	2002-1981/1000-429 ②		5,2 x 32,9 x 66,1/ 0.205 x 1.3 x 2.6 inch	12 V, 10 A ③;
	12 V; Circuit 2 ④	gray ⑤	2202-1981/1000-449	2002-1981/1000-449 ②			24 V, 10 A ④;
	24 V; Circuit 1 ③	gray ⑤	2202-1981/1000-413	2002-1981/1000-413 ②			48 V, 10 A ④;
	24 V; Circuit 2 ④	gray ⑤	2202-1981/1000-434	2002-1981/1000-434 ②			
	48 V; Circuit 1 ③	gray ⑤	2202-1981/1000-414	2002-1981/1000-414 ②			
	48 V; Circuit 2 ④	gray ⑤	2202-1981/1000-435	2002-1981/1000-435 ②			
	2-conductor fuse terminal block; with test point; without blown fuse indication; with additional jumper slot	gray ⑤	2202-1981	2002-1981 ②	50	5,2 x 32,9 x 72,9/ 0.205 x 1.3 x 2.87 inch	400 V/6 kV/3 ①; I <sub>n</sub> 10 A; 250 V, 10 A ③;
	End and intermediate plate; 1 mm thick	orange gray	2002-1992 2002-1991	2002-1992 2002-1991	25 25	1 x 32,9 x 72,9/ 0.04 x 1.3 x 2.87 inch	
<b>3-conductor fuse terminal block</b>							
	3-conductor fuse terminal block; with test point	gray ⑤	2202-1781	2002-1781 ②	50	5,2 x 32,9 x 76,8/ 0.205 x 1.3 x 2.6 inch	400 V/6 kV/3 ①; I <sub>n</sub> 10 A; 300 V, 10 A ③; 300 V, 10 A ④
	End and intermediate plate; 1 mm thick	orange gray	2002-1792 2002-1791	2002-1792 2002-1791	25 25	1 x 32,9 x 76,8/ 0.04 x 1.3 x 2.6 inch	
<b>4-conductor fuse terminal block</b>							
	4-conductor fuse terminal block; with test point	gray ⑤	2202-1881	2002-1881 ②	100	5,2 x 32,9 x 87,5/ 0.205 x 1.3 x 3.45 inch	400 V/6 kV/3 ①; I <sub>n</sub> 10 A; 300 V, 10 A ③; 300 V, 10 A ④
	End and intermediate plate; 1 mm thick	orange gray	2002-1892 2002-1891	2002-1892 2002-1891	25 25	1 x 32,9 x 87,5/ 0.04 x 1.3 x 3.45 inch	

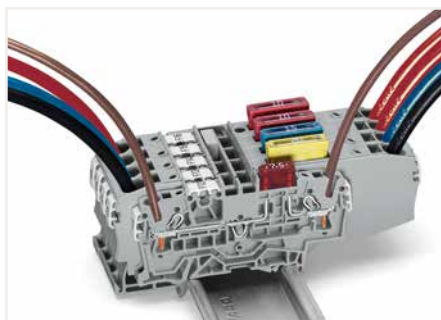
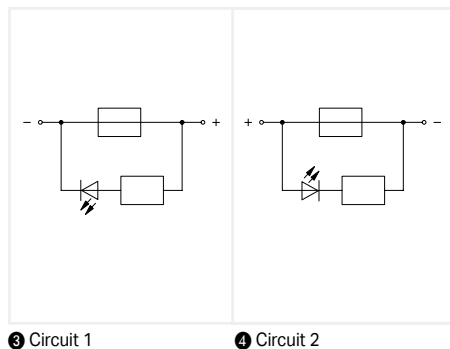

Selecting the correct fuse cartridge is important for product safety within applications, as well as for fuse cartridge service life and reliability. Fuse cartridges can operate perfectly as protection (break-off point) if they are properly selected and used according to manufacturer specifications.

Nominal current ratings for fuse cartridges are defined differently in international standards. This is why the recommended continuous current-carrying capacity of the fuses is a max. 80% of their nominal current according to DIN 72581/Part 3 (for a surrounding air temperature of 23°C). Regarding to product safety, fuse cartridges must generally be tested both under normal and faulty operating conditions within your application.

Conductor range: 0.25 ... 4 mm<sup>2</sup> "s+f-st"; Push-in termination: 1 ... 4 mm<sup>2</sup> "s" and 1 ... 2.5 mm<sup>2</sup> "insulated ferrules; 12 mm"; 22 ... 14 AWG; Strip length: 10 ... 12 mm / 0.39 ... 0.47 inch

- ① 400/250 V = rated voltage; 6 kV = rated impulse voltage; 3 = pollution degree
- ② Suitable for Ex e II applications; 550 V; 17 A

Accessories: see pages 36 ... 38.  
Marking: WMB/WMB Inline/Marking strips  
Suitable operating tool: see page 39

# WAGO Fused Disconnect Terminal Block with a Pivoting Fuse Holder TOPJOB® S; for (5 x 20) mm Glass Cartridge Fuses – 2002/2202 Series 2.5 (4) mm<sup>2</sup>

1

Image	Description	Color	With Push-Button Item No.	Without Push-Button Item No.	PU	Dimensions (W x H x D)	Electrical Data
<b>2-conductor fuse terminal block</b>							
	2-conductor fused disconnect terminal block with a pivoting fuse holder; for (5 x 20) mm glass cartridge fuse; without blown fuse indication	○ gray ☒	2202-1611	2002-1611 ②	50	6,2 x 57,2 x 66,1/ 0.24 x 2.23 x 2.6 inch	250 V/6 kV/3 ①; I <sub>n</sub> 6,3 A; 250 V, 6,3 A ②; 250 V, 6,3 A ③
	2-conductor fused disconnect terminal block with a pivoting fuse holder; for (5 x 20) mm glass cartridge fuse; with blown fuse indication by LED						
	12 ... 30 V	○ gray ☒	2202-1611/1000-541	2002-1611/1000-541 ②	50	6,2 x 57,2 x 66,1/ 0.24 x 2.23 x 2.6 inch	250 V/6 kV/3 ①; I <sub>n</sub> 6,3 A; 250 V, 6,3 A ②; 250 V, 6,3 A ③
	30 ... 65 V	○ gray ☒	2202-1611/1000-542	2002-1611/1000-542 ②	50		
	230 V	○ gray ☒	2202-1611/1000-836	2002-1611/1000-836 ②	50		
	120 V	○ gray ☒	2202-1611/1000-867	2002-1611/1000-867 ②	50		
	2-conductor fused disconnect terminal block with a pivoting fuse holder; with additional jumper slot; for (5 x 20) mm glass cartridge fuse; without blown fuse indication	○ gray ☒	2202-1911	2002-1911 ②	50	6,2 x 57,6 x 72,9/ 0.24 x 2.27 x 2.87 inch	250 V/6 kV/3 ①; I <sub>n</sub> 6,3 A; 600 V, 6,3 A ②
	2-conductor fused disconnect terminal block with a pivoting fuse holder; with additional jumper slot; for (5 x 20) mm glass cartridge fuse; with blown fuse indication by LED						
	12 ... 30 V	○ gray ☒	2202-1911/1000-541	2002-1911/1000-541 ②	50	6,2 x 57,2 x 66,1/ 0.24 x 2.23 x 2.6 inch	250 V/6 kV/3 ①; I <sub>n</sub> 6,3 A; 30 V, 6,3 A ②
	30 ... 65 V	○ gray ☒	2202-1911/1000-542	2002-1911/1000-542 ②	50		
	230 V	○ gray ☒	2202-1911/1000-836	2002-1911/1000-836 ②	50		
	120 V	○ gray ☒	2202-1911/1000-867	2002-1911/1000-867 ②	50		
<b>3-conductor fuse terminal block</b>							
	3-conductor fused disconnect terminal block with a pivoting fuse holder; for (5 x 20) mm glass cartridge fuse; without blown fuse indication	○ gray ☒	2202-1711	2002-1711 ②	50	6,2 x 57,6 x 76,8/ 0.24 x 2.23 x 3.02 inch	250 V/6 kV/3 ①; I <sub>n</sub> 6,3 A; 250 V, 6,3 A ②; 250 V, 6,3 A ③
	3-conductor fused disconnect terminal block with a pivoting fuse holder; for (5 x 20) mm glass cartridge fuse; with blown fuse indication by LED						
	12 ... 30 V	○ gray ☒	2202-1711/1000-541	2002-1711/1000-541 ②	50	6,2 x 57,6 x 76,8/ 0.24 x 2.23 x 3.02 inch	250 V/6 kV/3 ①; I <sub>n</sub> 6,3 A; 250 V, 6,3 A ②; 250 V, 6,3 A ③
	30 ... 65 V	○ gray ☒	2202-1711/1000-542	2002-1711/1000-542 ②	50		
	230 V	○ gray ☒	2202-1711/1000-836	2002-1711/1000-836 ②	50		
	120 V	○ gray ☒	2202-1711/1000-867	2002-1711/1000-867 ②	50		
<b>4-conductor fuse terminal block</b>							
	4-conductor fused disconnect terminal block with a pivoting fuse holder; for (5 x 20) mm glass cartridge fuse; without blown fuse indication	○ gray ☒	2202-1811	2002-1811 ②	100	6,2 x 57,6 x 87,5/ 0.24 x 2.23 x 3.44 inch	250 V/6 kV/3 ①; I <sub>n</sub> 6,3 A; 250 V, 6,3 A ②; 250 V, 6,3 A ③
	4-conductor fused disconnect terminal block with a pivoting fuse holder; for (5 x 20) mm glass cartridge fuse; with blown fuse indication by LED						
	12 ... 30 V	○ gray ☒	2202-1811/1000-541	2002-1811/1000-541 ②	50	6,2 x 57,6 x 87,5/ 0.24 x 2.23 x 3.44 inch	250 V/6 kV/3 ①; I <sub>n</sub> 6,3 A; 250 V, 6,3 A ②; 250 V, 6,3 A ③
	30 ... 65 V	○ gray ☒	2202-1811/1000-542	2002-1811/1000-542 ②	50		
	230 V	○ gray ☒	2202-1811/1000-836	2002-1811/1000-836 ②	50		
	120 V	○ gray ☒	2202-1811/1000-867	2002-1811/1000-867 ②	50		

**Miniature fuses 5 x 20**

Series Item No.	Overload and short circuit protection		Short circuit protection only	
	Individual argmt.	Group argmt.	Individual argmt.	Group argmt.
Fuse terminal blocks				
2202-1611	1.6 W	1.6 W	2.5 W	2.5 W
2202-1711				
2202-1811				
2202-1611/.....	1.6 W	1.6 W	2.5 W	2.5 W
2202-1711/.....				
2202-1811/.....				

**Miniature fuses 5 x 20**

Series Item No.	Overload and short circuit protection		Short circuit protection only	
	Individual argmt.	Group argmt.	Individual argmt.	Group argmt.
Fuse terminal blocks				
2202-1911	1.6 W	1.6 W	2.5 W	2.5 W
2202-1911/.....	1.6 W	1.6 W	2.5 W	2.5 W

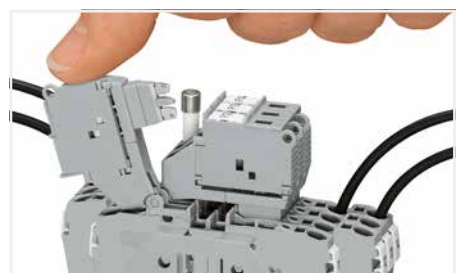

Conductor range: 0.25 ... 4 mm<sup>2</sup> "s+f-st";  
Push-in termination: 1 ... 4 mm<sup>2</sup> "s" and 1 ... 2.5 mm<sup>2</sup>  
"insulated ferrules; 12 mm"; 22 ... 14 AWG;  
Strip length: 10 ... 12 mm / 0.39 ... 0.47 inch

- ① 250 V = rated voltage  
6 kV = rated impulse voltage  
3 = pollution degree
- ② Suitable for Ex e II applications; 550 V; 17 A

Accessories: see pages 36 ... 38.  
Marking: WMB/WMB Inline/Marking strips  
Suitable operating tool: see page 39



# WAGO Disconnect/Test Terminal Block; WAGO Through Terminal Block; WAGO Ground Conductor Disconnect Terminal Block TOPJOB® S of Same Profile – 2006 Series 6 (10) mm<sup>2</sup>

Image	Description	Color	Item No.	PU	Dimensions (W x H x D)	Electrical Data
<b>2-conductor disconnect/test/through/carrier terminal block</b>						
	2-conductor disconnect/test terminal block; with test point; orange disconnect link	gray ☉	2006-1671	25	7,5 x 36,8 x 96,3 mm/ 0.295 x 1.47 x 3.79 inch	800 V/6 kV/3 ①; I <sub>N</sub> 30 A; 600 V, 15 A ②; 600 V, 30 A ③
		blue ☉	2006-1674	25		
	2-conductor through terminal block; with test point; same profile as 2-conductor disconnect terminal block	gray ☉	2006-1601	25	7,5 x 32,9 x 96,3 mm/ 0.295 x 1.3 x 3.79 inch	800 V/6 kV/3 ①; I <sub>N</sub> 30 A; 600 V, 30 A ②; 600 V, 30 A ③
		blue ☉	2006-1604	25		
	2-conductor disconnect/test terminal block; with test point; orange disconnect link	gray ☉	2006-8671	12	15 x 59,2 x 106,9 mm/ 0.501 x 2.33 x 4.21 inch	1000 VAC/ DC/1500 VDC/ 12 kV/3 ①; I <sub>N</sub> 30 A; 600 V, 30 A ②; 1000 V, 30 A ③
		blue ☉	2006-8674	12		
	2-conductor through terminal block; with test point; same profile as 2-conductor disconnect terminal block	gray ☉	2006-8601	12	15 x 33 x 106,9 mm/ 0.501 x 1.3 x 4.21 inch	1000 VAC/ DC/1500 VDC/ 12 kV/3 ①; I <sub>N</sub> 30 A; 600 V, 30 A ②; 1000 V, 30 A ③
		blue ☉	2006-8604	12		
	2-conductor carrier terminal block; with test point	gray ☉	2006-8661	12	15 x 33 x 106,9 mm/ 0.501 x 1.3 x 4.21 inch	1000 VAC/ DC/1500 VDC/ 12 kV/3 ①; I <sub>N</sub> 30 A; 600 V, 30 A ②; 1000 V, 30 A ③
		blue ☉	2006-8664	12		
	Disconnect plug for carrier terminal blocks; suitable when using a carrier terminal block as disconnect terminal block	orange	2006-401	25		I <sub>N</sub> 30 A
	End and intermediate plate; 1 mm thick	orange	2002-1892	25	1 x 31,6 x 106,5/	
		gray	2002-1891	25	0.04 x 1.24 x 4.19 inch	

<b>Ground conductor disconnect terminal block</b>						
	Ground conductor disconnect terminal block; with test point; orange disconnect link					
	24 V AC/DC	gray	2006-1671/1000-848	12	15 x 33 x 106,9 mm/ 0.501 x 1.3 x 4.21 inch	
	48 VAC/DC	gray	2006-1671/1000-849	12		
	120 VAC/DC	gray	2006-1671/1000-850	12		
	230 VAC/VDC	gray	2006-1671/1000-851	12		

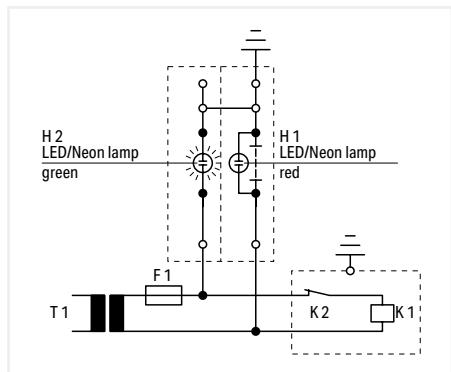

**Operation**  
Slide link closed, auxiliary circuit grounded, green LED/neon lamp illuminates.

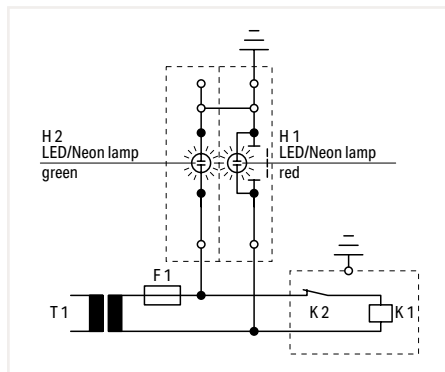

**Test condition – No grounding**  
Slide link open, auxiliary circuit not grounded.

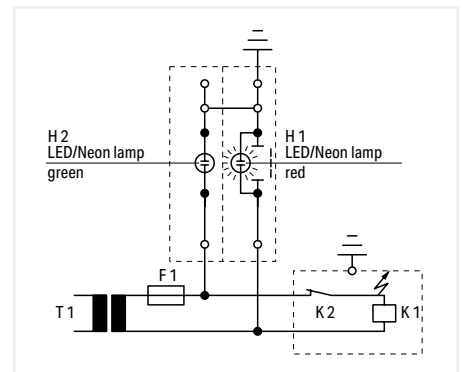

**Test condition – Grounding**  
Slide link open, auxiliary circuit not grounded, red LED/neon lamp illuminates.

Conductor range: 0.5 ... 10 mm<sup>2</sup> "s+f-st"; Push-in termination: 2.5 ... 10 mm<sup>2</sup> "s" and 2.5 ... 6 mm<sup>2</sup> "insulated ferrules; 12 mm"; 20 ... 8 AWG; Strip length: 13 ... 15 mm / 0.51 ... 0.59 inch

① 800/1000/1500 V = rated voltage; 6/12 kV = rated impulse voltage; 3 = pollution degree

Accessories: see pages 36 ... 38.  
Marking: WMB/WMB Inline/Marking strips  
Suitable operating tool: see page 39

# WAGO Fused Disconnect Terminal Block TOPJOB® S; with a Pivoting Fuse Holder; for (5 x 20) mm, (5 x 30) mm and 1/4" x 11/4" Glass Cartridge Fuses – 2006 Series 6 (10) mm<sup>2</sup>

1

Image	Description	Color	Item No.	PU	Dimensions (W x H x D)	Electrical Data
<b>2-conductor fuse terminal block</b>						
	2-conductor fuse terminal block for automotive blade-style fuses; with test point; with blown fuse indication by LED; LED power consumption: 4.8 mA					250 V/6 kV/3 ①; I <sub>n</sub> 25 A (30 A)
	12 V; Circuit 1 ②	○ gray	2006-1681/1000-429	25	7,5 x 32,9 x 96,3/ 0.295 x 1.3 x 3.79 inch	12 V, 15 A ②; 12 V, 30 A ③
	12 V; Circuit 2 ③	○ gray	2006-1681/1000-449	25		24 V, 15 A ②; 24 V, 30 A ③
	24 V; Circuit 1 ②	○ gray	2006-1681/1000-413	25		48 V, 30 A ②; 48 V, 30 A ③
	24 V; Circuit 2 ③	○ gray	2006-1681/1000-434	25		
	48 V; Circuit 1 ②	○ gray	2006-1681/1000-414	25		
48 V; Circuit 2 ③	○ gray	2006-1681/1000-435	25			
	2-conductor fuse terminal block for automotive blade-style fuses; with test point; without blown fuse indication	○ gray	2006-1681	25	7,5 x 32,9 x 96,3/ 0.295 x 1.3 x 3.79 inch	500 V/6 kV/3 ①; I <sub>n</sub> 25 A (30 A); 600 V, 15 A ②; 600 V, 30 A ③
<b>2-conductor fused disconnect terminal block with a pivoting fuse holder</b>						
	2-conductor fused disconnect terminal block with a pivoting fuse holder; without blown fuse indication					800 V/8 kV/3 ①; I <sub>n</sub> 10 A; 600 V, 15 A ②; 600 V, 15 A ③
	for (5 x 20) mm glass cartridge fuse	○ gray	2006-1611	25	7,5 x 59 x 96,3/ 0.295 x 2.32 x 3.79 inch	
	for (5 x 30) mm glass cartridge fuse	○ gray	2006-1621	25		
for 1/4" x 11/4" glass cartridge fuse	○ gray	2006-1631	25			
	2-conductor fused disconnect terminal block with a pivoting fuse holder; with blown fuse indication by LED					
	for (5 x 20) mm glass cartridge fuse; 12 ... 30 V	○ gray	2006-1611/1000-541	25	7,5 x 59 x 96,3/ 0.295 x 2.32 x 3.79 inch	800 V/8 kV/3 ①; I <sub>n</sub> 10 A; 30 V, 15 A ②; 30 V, 15 A ③
	for (5 x 20) mm glass cartridge fuse; 30 ... 65 V	○ gray	2006-1611/1000-542	25		
	for (5 x 20) mm glass cartridge fuse; 120 V	○ gray	2006-1611/1000-867	25		
	for (5 x 20) mm glass cartridge fuse; 230 V	○ gray	2006-1611/1000-836	25		
	for (5 x 30) mm glass cartridge fuse; 12 ... 30 V	○ gray	2006-1621/1000-541	25		
	for (5 x 30) mm glass cartridge fuse; 30 ... 65 V	○ gray	2006-1621/1000-542	25		
	for (5 x 30) mm glass cartridge fuse; 120 V	○ gray	2006-1621/1000-867	25		
	for (5 x 30) mm glass cartridge fuse; 230 V	○ gray	2006-1621/1000-836	25		
	for (5 x 30) mm glass cartridge fuse; 308 ... 500 V	○ gray	2006-1621/1000-859	25		
	for 1/4" x 11/4" glass cartridge fuse; 12 ... 30 V	○ gray	2006-1631/1000-541	25		
	for 1/4" x 11/4" glass cartridge fuse; 30 ... 65 V	○ gray	2006-1631/1000-542	25		
	for 1/4" x 11/4" glass cartridge fuse; 120 V	○ gray	2006-1631/1000-867	25		
for 1/4" x 11/4" glass cartridge fuse; 230 V	○ gray	2006-1631/1000-836	25			
for 1/4" x 11/4" glass cartridge fuse; 308 ... 500 V	○ gray	2006-1631/1000-859	25			
	2-conductor fused disconnect terminal block with a pivoting fuse holder and end plate, for 1/4" x 11/4" glass cartridge fuse; without blown fuse indication	○ gray	2006-1631/099-000	25	10,4 x 59 x 96,3/ 0.409 x 2.32 x 3.79 inch	800 V/8 kV/3 ①; I <sub>n</sub> 10 A; 600 V, 15 A ②; 600 V, 15 A ③
	2-conductor fused disconnect terminal block with a pivoting fuse holder and end plate; with blown fuse indication by LED					
	for 1/4" x 11/4" glass cartridge fuse; 12 ... 30 V	○ gray	2006-1631/1099-541	25	10,4 x 59 x 96,3/ 0.409 x 2.32 x 3.79 inch	800 V/8 kV/3 ①; I <sub>n</sub> 10 A; 30 V, 15 A ②; 30 V, 15 A ③
	for 1/4" x 11/4" glass cartridge fuse; 30 ... 65 V	○ gray	2006-1631/1099-542	25		
	for 1/4" x 11/4" glass cartridge fuse; 120 V	○ gray	2006-1631/1099-867	25		
	for 1/4" x 11/4" glass cartridge fuse; 230 V	○ gray	2006-1631/1099-836	25		
for 1/4" x 11/4" glass cartridge fuse; 308 ... 500 V	○ gray	2006-1631/1099-859	25			

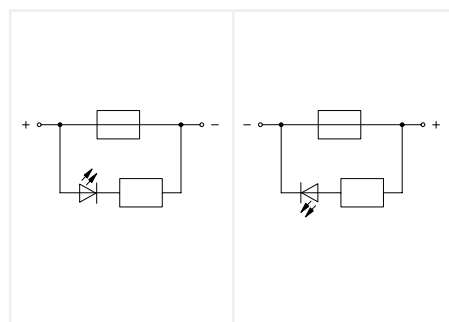

② Circuit 1

③ Circuit 2

Conductor range: 0.5 ... 10 mm<sup>2</sup> "s+f-st"; Push-in termination: 2.5 ... 10 mm<sup>2</sup> "s" and 2.5 ... 6 mm<sup>2</sup> "insulated ferrules; 12 mm"; 20 ... 8 AWG; Strip length: 13 ... 15 mm / 0.51 ... 0.59 inch

### Glass cartridge fuses

Series Item No.	Overload and short circuit protection		Short circuit protection only	
	Individual argmt.	Group argmt.	Individual argmt.	Group argmt.
Fused disconnect terminal blocks				
2006-1611	7.5	1.6 W	1.6 W	2.5 W
2006-1621	7.5	1.6 W	1.6 W	2.5 W
2006-1631	7.5	1.6 W	1.6 W	2.5 W
2006-1631 /099-...	10.4	2.5 W	2.5 W	2.5 W
2006-1631 /1099-...	10.4	2.5 W	2.5 W	2.5 W

① 250/500/800 V = rated voltage; 6/8 kV = rated impulse voltage; 3 = pollution degree

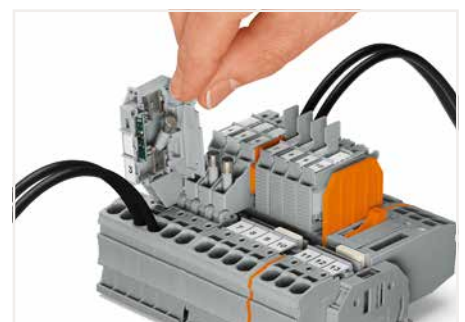

**Fuse replacement:**  
Open the cover to replace the fuse.

Accessories: see pages 36 ... 38.

Marking: WMB/WMB Inline/Marking strips

Suitable operating tool: see page 39

# WAGO Disconnect/Test Terminal Blocks; Through/Ground Terminal Blocks TOPJOB® S; for Current/Voltage Transformer Circuits Operation

1



Measuring set for a three-phase current transformer  
Terminal blocks required:

- 6 x disconnect/test terminal block (2007-8821)
- 3 x circuit jumper, orange (2007-8442)
- In addition: interlocking link, locking cover, lock-out



Additional commoning option on the transformer side



Multipole switching via snap-on type, transparent (locking) cover for disconnect links.



Preparing shorting path for the current transformer circuits.



Insert insulated, touch-proof circuit jumpers into jumper slot.



A lock-out seal can be used on the disconnect link in operating position I when combined with an end and separator plate (2007-8893 or 2007-8894).



Lock-out prevents accidental operation of disconnect link.



Lock-out snaps into one of two notched positions.



Marking via WMB Multi markers or marking strips.



### Example for voltage transformer testing

Measuring set for single-phase voltage transformer testing

Terminal blocks required:

- 1 x disconnect/test terminal block (2007-8811)
- 1 x through terminal block (2007-8801)
- 1 x end plate, orange (2007-8892)
- In addition: locking cover, lock-out

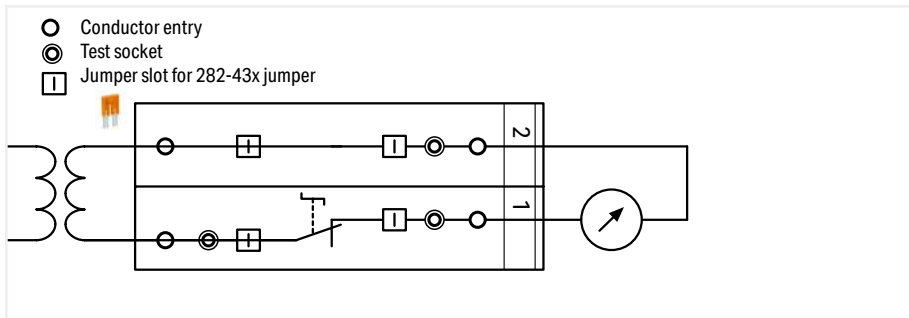

Disconnecting the voltage transformer from the circuit: Move disconnect link from operating position to measurement position.

Voltage measurement: Connecting a measurement device via test socket on the meter side can only be performed after disconnection is complete (measuring point).

# WAGO Disconnect/Test Terminal Blocks, Through/Ground Terminal Blocks TOPJOB® S; for Current and Voltage Transformer Circuits Operation (Continued)

1



**Disconnect link in operating position I**  
Terminal blocks required:  
2 x disconnect/test terminal block (2007-8821)  
1 x circuit jumper, orange (2007-8442)  
Locking covers or interlocking links (option)

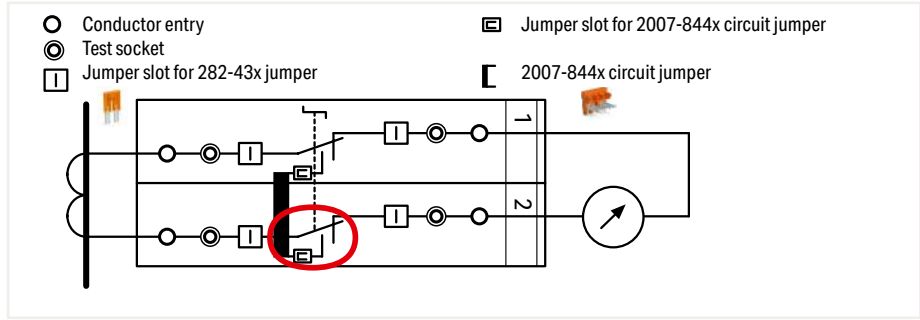

In the operating position, the measurement device is connected to the transformer, the circuit jumper is inserted and the disconnect link is in position I.



**Disconnect link in shorting position II**

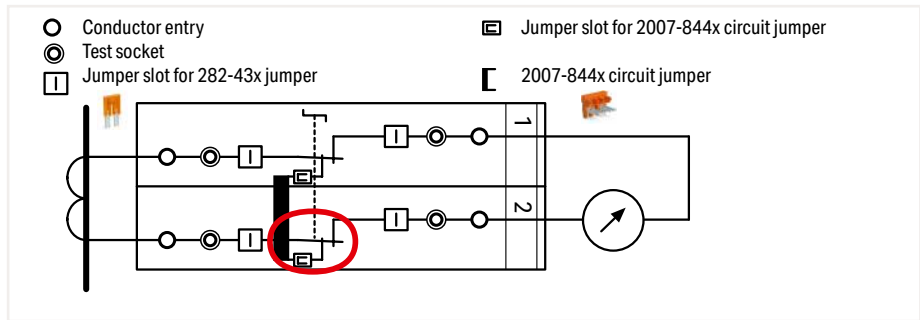

The transformer is not disconnected from the measuring device yet, the shorting path is activated by moving the disconnect link into shorting position II and the transformer is safely shorted.



**Test current measurement: Disconnect link in measuring position III**

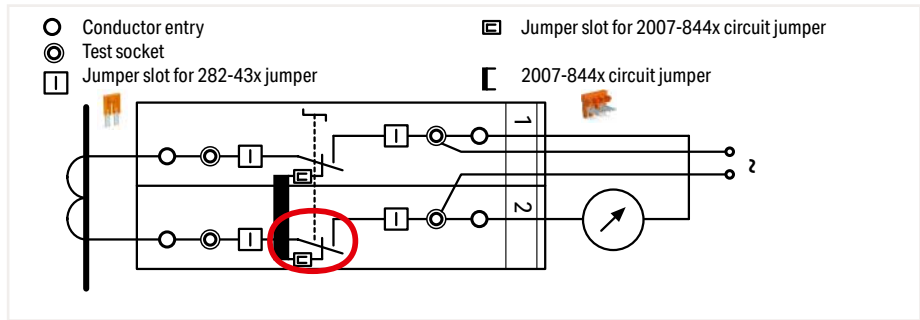

The measuring device is electrically disconnected from the transformer. If required, an external voltage can be applied to the measuring device via the test socket.



**Measurement testing (using both test sockets)**  
Terminal block 1: Disconnect link in operating position I  
Terminal block 2: Disconnect link in measuring position III

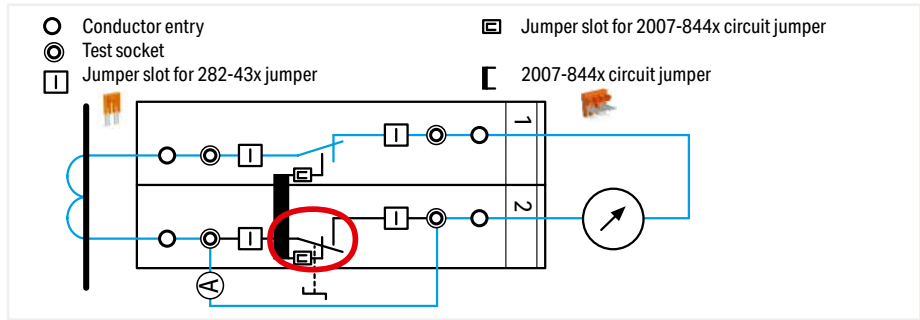













Measurement testing: First insert the reference current meter (A) into the test socket, then move the disconnect link into measurement point III (test current measurement).

Conductor range: 0.5 ... 10 mm<sup>2</sup> "s+f-st"; Push-in termination: 2.5 ... 10 mm<sup>2</sup> "s" and 2.5 ... 6 mm<sup>2</sup> "insulated ferrules; 12 mm"; 20 ... 8 AWG;  
Strip length: 13 ... 15 mm / 0.51 ... 0.59 inch

① 500 V = Bemessungsspannung  
6 Kv = Bemessungsstoßspannung  
3 = Verschmutzungsgrad

Accessories: see pages 36 ... 38.  
Marking: WMB/Marking strips  
Suitable operating tool: see page 39

# WAGO Disconnect/Test Terminal Block, Through/Ground Terminal Block TOPJOB® S; for Current and Voltage Transformer Circuits – 2007 Series 6 mm<sup>2</sup>

Image	Description	Color	Item No.	PU	Dimensions (W x H x D)	Electrical Data
<b>2-conductor disconnect/test/through/ground terminal block</b>						
	2-conductor disconnect/test terminal block; e.g., for current transformer circuits; with circuit jumper slot; with touch-proof test sockets; for 4 mm Ø test plugs	○ gray	2007-8821	20	8 x 65,3 x 99,6 mm / 0.315 x 2.57 x 3.92 inch	500 V/6 kV/3 ①; I <sub>N</sub> 30 A; 300 V, 30 A ②
	Circuit jumper; insulated					
	2-way	● orange	2007-8842	10		
	3-way	● orange	2007-8843	10		I <sub>N</sub> 30 A
	⋮		⋮			
	8-way	● orange	2007-8848	10		
	2-conductor disconnect/test terminal block; e.g., for voltage transformer circuits; with touch-proof test sockets; for 4 mm Ø test plugs	○ gray	2007-8811	20	8 x 65,3 x 99,6 mm / 0.315 x 2.57 x 3.92 inch	500 V/6 kV/3 ①; I <sub>N</sub> 30 A; 300 V, 30 A ②
	2-conductor through terminal block; with touch-proof test socket; for 4 mm Ø test plugs	○ gray ● blue	2007-8801 2007-8804	20 20	8 x 46,8 x 99,6 mm / 0.315 x 1.85 x 3.92 inch	500 V/6 kV/3 ①; I <sub>N</sub> 30 A; 300 V, 30 A ②
	2-conductor ground terminal block; with touch-proof test socket; for 4 mm Ø test plugs	● green-yellow	2007-8807	20	8 x 46,8 x 99,6 mm / 0.315 x 1.85 x 3.92 inch	
	End and separator plate; 1.5 mm thick; without lock-out seal option	● orange ○ gray	2007-8892 2007-8891	25 25	1,5 x 46,8 x 99,3 mm / 0.06 x 1.85 x 3.91 inch	
	End and separator plate; 1.5 mm thick; with lock-out seal option	● orange ○ gray	2007-8894 2007-8893	25 25	1,5 x 50,5 x 99,3 mm / 0.06 x 1.99 x 3.91 inch	
<b>Accessories</b>						
	Jumper; insulated					
	2-way	orange	282-432	10		
	3-way	orange	282-433	10		I <sub>N</sub> 30 A
	⋮		⋮			
	10-way	orange	282-440	10		
	Jumper with safety lid; insulated					
	2-way	orange	282-432/100-000	10		
	3-way	orange	282-433/100-000	10		I <sub>N</sub> 30 A
	4-way	orange	282-434/100-000	10		
	Jumper; insulated					
	1-3	orange	282-433/011-000	10		
	1-3-5	orange	282-435/011-000	10		
	1-4-5	orange	282-435/301-000	10		
	1-3-4-5	orange	282-435/300-000	10		
	1-2-4-6	orange	282-436/301-000	10		
	1-4-6	orange	282-436/304-000	10		I <sub>N</sub> 30 A
	1-3-5-7	orange	282-437/011-000	10		
	1-4-7	orange	282-437/012-000	10		
	1-2-5-8	orange	282-438/300-000	10		
	1-4-7-8	orange	282-438/301-000	10		
	1-3-5-7-9	orange	282-439/011-000	10		
	Locking cover; mechanically locks multiple links					
	1-pole	transparent	282-881	10		
	2-pole	transparent	282-882	10		
	⋮		⋮			
	8-pole	transparent	282-888	10		
	Interlocking link; mechanically locks multiple links	transparent	210-254	1		

# WAGO Double-Deck Disconnect/Test Terminal Block TOPJOB® S – 2002 Series

## 2.5 (4) mm<sup>2</sup>

1

Image	Description	Color	Item No.	PU	Potential Marking	Electrical Data
<b>Double-deck disconnect/test terminal block</b>						
	Double-deck, double-disconnect terminal block; with two pivoting knife disconnects	○ gray ☺	2002-2951 ②	50	L/L	400 V/6 kV/3 ①; I <sub>N</sub> 16 A; 300 V, 15 A ③; 300 V, 15 A ④
		○ gray ☺	2002-2952 ②	50	N/L	
		● blue ☺	2002-2954 ②	50	N/N	
	Double-deck, double-disconnect terminal block; with two pivoting knife disconnects; lower and upper decks internally commoned and violet conductor entry	○ gray ☺	2002-2958 ②	50	L/L	400 V/6 kV/3 ①; I <sub>N</sub> 16 A; 300 V, 15 A ③; 300 V, 15 A ④
		● blue ☺	2002-2959 ②	50	N/N	
	Double-deck disconnect terminal block; with pivoting knife disconnect; same profile as double-deck, double-disconnect terminal block	○ gray ☺	2002-2971 ②	50	L/L	400 V/6 kV/3 ①; I <sub>N</sub> 16 A; 300 V, 15 A ③; 300 V, 15 A ④
		○ gray ☺	2002-2972 ②	50	N/L	
		● blue ☺	2002-2974 ②	50	N/N	
	End and intermediate plate; 1 mm thick	● orange	2002-2992	25		
		○ gray	2002-2991	25		
<b>Double-deck disconnect and carrier terminal block</b>						
	Double-deck disconnect terminal block; with a pivoting knife disconnect	○ gray ☺	2002-2671 ②	50	L/L	400 V/6 kV/3 ①; I <sub>N</sub> 16 A; 300 V, 20 A ③
		○ gray ☺	2002-2672 ②	50	N/L	
		○ gray ☺	2002-2678 ②	50	Shield/L	
	Double-deck carrier terminal block; upper-deck base	○ gray ☺	2002-2661 ②	50	L/L	400 V/6 kV/3 ①; I <sub>N</sub> 16 A; 300 V, 20 A ③
		○ gray ☺	2002-2662 ②	50	N/L	
		○ gray ☺	2002-2667 ②	50	GND/L	
	End and intermediate plate; 1 mm thick	● orange	2002-2692	25		
		○ gray	2002-2691	25		

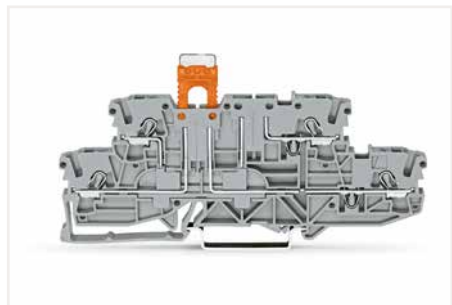

Carrier terminal block (2002-2941) with disconnect plug (2002-401) in parked position

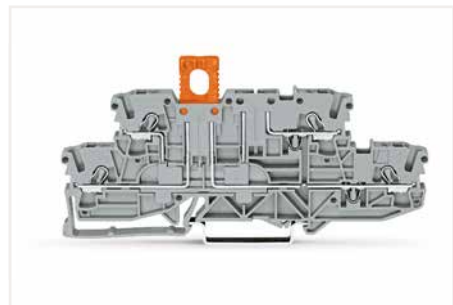

Carrier terminal block (2002-2941) with disconnect plug (2002-401) in operating position

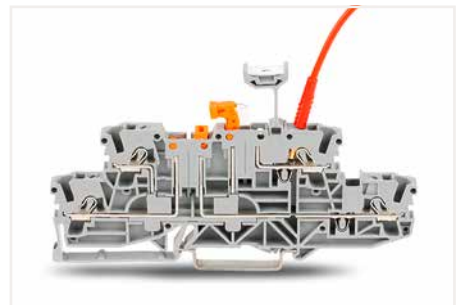

Double-deck, double-disconnect terminal block (2002-2951) with group marker carrier (2002-160) accommodated in a jumper contact slot and test plug (210-136)

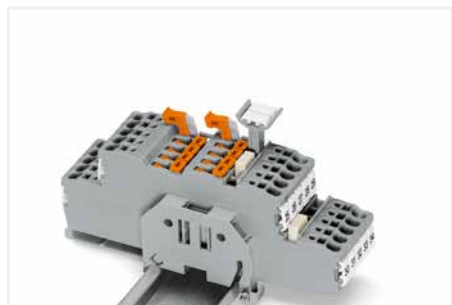

Double-deck, double-disconnect terminal blocks (2002-2951) with group marker carrier accommodated in jumper contact slot

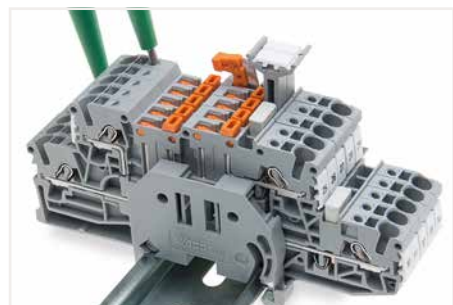

Testing with voltage tester.



Double-deck disconnect terminal blocks with a pivoting knife disconnect (2002-2671) can be used as through terminal blocks on the lower deck and as disconnect terminal blocks on the upper deck.

Conductor range: 0.25 ... 4 mm<sup>2</sup> "s+f-st"; Push-in termination: 1 ... 4 mm<sup>2</sup> "s" and 1 ... 2.5 mm<sup>2</sup> "insulated ferrules; 12 mm"; 22 ... 12 AWG; Strip length: 10 ... 12 mm / 0.39 ... 0.47 inch  
Accessories: see pages 36 ... 38.

Dimensions (W x H x D): 5.2 x 42 x 108 mm / 0.205 x 1.65 x 4.25 inch  
Marking: WMB/WMB Inline/Marking strips

① 400 V = rated voltage  
6 kV = rated impulse voltage  
3 = pollution degree  
② Suitable for Ex ec IIc applications  
Suitable operating tool: see page 39

## WAGO Double-Deck Fuse Terminal Block TOPJOB® S – 2002 Series

### 2.5 (4) mm<sup>2</sup>

Image	Description	Color	Item No.	PU	Potential Marking	Electrical Data
<b>Double-deck disconnect/test terminal block</b>						
	Double-deck fuse disconnect terminal block; with a pivoting fuse holder; Through/fuse terminal block; for (5 x 20) mm glass cartridge fuse; without blown fuse indication	○ gray ②	2002-2611 ②	25	L/L	250 V/6 kV/3 ①; I <sub>N</sub> 6,3 A; 300 V, 6,3 A ③
		○ gray ②	2002-2612 ②	25	N/L	
	Double-deck fuse disconnect terminal block; with a pivoting fuse holder; Through/fuse terminal block; for (5 x 20) mm glass cartridge fuse; with blown fuse indication					250 V/6 kV/3 ①; I <sub>N</sub> 6,3 A; 300 V, 6,3 A ③
		○ gray ②	2002-2611/1000-541 ②	25		
		○ gray ②	2002-2611/1000-542 ②	25		
		○ gray ②	2002-2611/1000-867 ②	25		
	End and intermediate plate; 1 mm thick	○ orange	2002-2692	25		
		○ gray	2002-2691	25		
		○ gray	2002-1091	25		
	End plate for fuse terminal blocks; oversized; 2 mm thick	○ orange	2002-1092	25		
		○ gray	2002-1091	25		
<b>Double-deck carrier terminal block; upper-deck base</b>						
	Double-deck carrier terminal block	○ gray	2002-2661 ②	50	L/L	400 V/6 kV/3 ①; I <sub>N</sub> 16 A; 300 V, 20 A ③
		○ gray	2002-2662 ②	50	N/L	
		○ gray	2002-2667 ②	50	GND/L	
	End and intermediate plate; 1 mm thick	○ orange	2002-2692	25		
		○ gray	2002-2691	25		
<b>TOPJOB® S Fuse Plug for carrier terminal block, 2.5 mm<sup>2</sup> (also suitable for 2002-1661/-1761/-1861/-1961 Single-Deck Carrier Terminal Blocks)</b>						
	Fuse plug with pull-tab; for (5 x 20) mm glass cartridge fuses	○ gray	2004-911	50		250 V / I <sub>N</sub> 6,3 A
	Fuse plug with pull-tab; for (5 x 20) mm glass cartridge fuses; with LED					250 V / I <sub>N</sub> 6,3 A
		○ gray	2004-911/1000-541	50		
		○ gray	2004-911/1000-542	50		
		○ gray	2004-911/1000-867	50		
	230 V	○ gray	2004-911/1000-836	50		



Double-deck fuse disconnect terminal blocks with a pivoting fuse holder (2002-2611, gray) are compatible with disconnect, carrier, through and ground conductor terminal blocks. The fuse holder is also available with a blown fuse LED indicator (e.g., 2002-2611/1000-541 for 12–30 V).

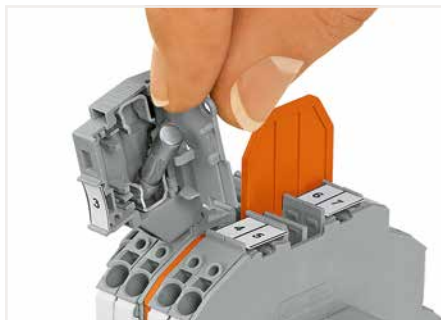

An end plate for fuse disconnect terminal blocks (shown in orange, 2002-1092) is used for additional protection, preventing the fuse holder from being opened. The fuse cannot be replaced until disconnecting the fuse holder from the power supply.

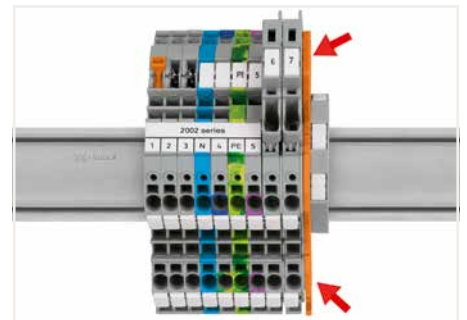

Additionally, an end plate for fuse terminal blocks (e.g., 2002-1092, orange) must be used at the end of an assembly or if there is no adjacent fuse terminal block.

Conductor range: 0.25 ... 4 mm<sup>2</sup> "s+f-st"; Push-in termination:  
1 ... 4 mm<sup>2</sup> "s" and 1 ... 2.5 mm<sup>2</sup> "insulated ferrules;  
12 mm"; 22 ... 12 AWG;  
Strip length: 10 ... 12 mm / 0.39 ... 0.47 inch  
Accessories: see pages 36 ... 38.

Dimensions (W x H x D):  
6.2 x 76.4 x 93 mm / 0.24 x 3.01 x 3.66 inch

Marking: WMB/WMB Inline/Marking strips

① 250 V = rated voltage  
6 kV = rated impulse voltage  
3 = pollution degree

② Suitable for Ex ec IIc applications

Suitable operating tool: see page 39

# WAGO Diode Terminal Block and LED Terminal Block TOPJOB® S – 2001 Series

## 1.5 (2.5) mm<sup>2</sup>

1

Image	Circuit diagram	Description	Color	Item No.	PU	Dimensions (W x H x D)	Electrical Data
<b>2-conductor diode terminal block</b>							
		2-conductor diode terminal block; with 1N4007 diode	○ gray	2001-1211/1000-411	100	4,2 x 32,9 x 48,5 mm / 0.165 x 1.3 x 1.91 inch	U <sub>N</sub> 250 V; U <sub>RM</sub> 1000 V; 1N4007 – 0.5 A continuous current
		2-conductor diode terminal block; with 1N4007 diode	○ gray	2001-1211/1000-410	100	4,2 x 32,9 x 48,5 mm / 0.165 x 1.3 x 1.91 inch	U <sub>N</sub> 250 V; U <sub>RM</sub> 1000 V; 1N4007 – 0.5 A continuous current
		End and intermediate plate; 0.8 mm thick	● orange	2002-1292	25	0,8 x 33 x 48,5 mm /	
			○ gray	2002-1291	25	0.03 x 1.3 x 1.91 inch	
<b>3-conductor diode terminal block/3-conductor LED terminal block</b>							
		3-conductor diode terminal block; with 1N4007 diode	○ gray	2001-1311/1000-411	100	4,2 x 32,9 x 59,2 mm / 0.165 x 1.3 x 2.33 inch	U <sub>N</sub> 250 V; U <sub>RM</sub> 1000 V; 1N4007 – 0.5 A continuous current
		3-conductor diode terminal block; with 1N4007 diode	○ gray	2001-1311/1000-410	100	4,2 x 32,9 x 59,2 mm / 0.165 x 1.3 x 2.33 inch	U <sub>N</sub> 250 V; U <sub>RM</sub> 1000 V; 1N4007 – 0.5 A continuous current
		3-conductor LED terminal block; with red LED	○ gray	2001-1321/1000-434	100	4,2 x 32,9 x 59,2 mm / 0.165 x 1.3 x 2.33 inch	24 VDC; I <sub>f</sub> 0.025 (max.)
		3-conductor LED terminal block; with red LED	○ gray	2001-1321/1000-413	100	4,2 x 32,9 x 59,2 mm / 0.165 x 1.3 x 2.33 inch	24 VDC; I <sub>f</sub> 0.025 (max.)
		End and intermediate plate; 0.8 mm thick	● orange	2002-1392	25	0,8 x 33 x 59,5 mm /	
			○ gray	2002-1391	25	0.03 x 1.3 x 2.34 inch	
<b>4-conductor diode terminal block/4-conductor LED terminal block</b>							
		4-conductor diode terminal block; with 1N4007 diode	○ gray	2001-1411/1000-411	100	4,2 x 32,9 x 69,9 mm / 0.165 x 1.3 x 2.75 inch	U <sub>N</sub> 250 V; U <sub>RM</sub> 1000 V; 1N4007 – 0.5 A continuous current
		4-conductor diode terminal block; with 1N4007 diode	○ gray	2001-1411/1000-410	100	4,2 x 32,9 x 69,9 mm / 0.165 x 1.3 x 2.75 inch	U <sub>N</sub> 250 V; U <sub>RM</sub> 1000 V; 1N4007 – 0.5 A continuous current
		4-conductor LED terminal block; with red LED	○ gray	2001-1421/1000-434	100	4,2 x 32,9 x 69,9 mm / 0.165 x 1.3 x 2.75 inch	24 VDC; I <sub>f</sub> 0.025 (max.)
		4-conductor LED terminal block; with red LED	○ gray	2001-1421/1000-413	100	4,2 x 32,9 x 69,9 mm / 0.165 x 1.3 x 2.75 inch	24 VDC; I <sub>f</sub> 0.025 (max.)
		End and intermediate plate; 0.8 mm thick	● orange	2002-1492	25	0,8 x 33 x 70 mm /	
			○ gray	2002-1491	25	0.03 x 1.3 x 2.76 inch	

Conductor range: 0.25 ... 2.5 mm<sup>2</sup> "s+f-st"; Push-in termination: 0.75 ... 2.5 mm<sup>2</sup> "s" and 0.75 ... 1.5 mm<sup>2</sup> "insulated ferrules; 12 mm"; 22 ... 14 AWG; Strip length: 9 ... 11 mm / 0.35 ... 0.43 inch

Accessories: see pages 36 ... 38.

Marking: WMB/WMB Inline/Marking strips

Suitable operating tool: see page 39



## WAGO Diode Terminal Block and LED Terminal Block TOPJOB® S – 2002 Series

### 2.5 (4) mm<sup>2</sup>

Image	Circuit diagram	Description	Color	Item No.	PU	Dimensions (W x H x D)	Electrical Data
<b>2-conductor diode terminal block</b>							
		2-conductor diode terminal block; with 1N4007 diode	○ gray	2002-1211/1000-411	100	5,2 x 32,9 x 48,5 mm / 0.205 x 1.3 x 1.91 inch	U <sub>N</sub> 250 V; U <sub>RM</sub> 1000 V; 1N4007 – 0.5 A continuous current
		2-conductor diode terminal block; with 1N4007 diode	○ gray	2002-1211/1000-410	100	5,2 x 32,9 x 48,5 mm / 0.205 x 1.3 x 1.91 inch	U <sub>N</sub> 250 V; U <sub>RM</sub> 1000 V; 1N4007 – 0.5 A continuous current
		End and intermediate plate; 0.8 mm thick	● orange	2002-1292	25	0,8 x 33 x 48,5 mm /	
			○ gray	2002-1291	25	0.03 x 1.3 x 1.91 inch	
<b>3-conductor diode terminal block/3-conductor LED terminal block</b>							
		3-conductor diode terminal block; with 1N4007 diode	○ gray	2002-1311/1000-411	100	5,2 x 32,9 x 59,2 mm / 0.205 x 1.3 x 2.33 inch	U <sub>N</sub> 250 V; U <sub>RM</sub> 1000 V; 1N4007 – 0.5 A continuous current
		3-conductor diode terminal block; with 1N4007 diode	○ gray	2002-1311/1000-410	100	5,2 x 32,9 x 59,2 mm / 0.205 x 1.3 x 2.33 inch	U <sub>N</sub> 250 V; U <sub>RM</sub> 1000 V; 1N4007 – 0.5 A continuous current
		3-conductor LED terminal block; with red LED	○ gray	2002-1321/1000-434	100	5,2 x 32,9 x 59,2 mm / 0.205 x 1.3 x 2.33 inch	24 VDC; I <sub>f</sub> 0.025 (max.)
		3-conductor LED terminal block; with red LED	○ gray	2002-1321/1000-413	100	5,2 x 32,9 x 59,2 mm / 0.205 x 1.3 x 2.33 inch	24 VDC; I <sub>f</sub> 0.025 (max.)
		End and intermediate plate; 0.8 mm thick	● orange	2002-1392	25	0,8 x 33 x 59,5 mm /	
			○ gray	2002-1391	25	0.03 x 1.3 x 2.34 inch	
<b>4-conductor diode terminal block/4-conductor LED terminal block</b>							
		4-conductor diode terminal block; with 1N4007 diode	○ gray	2002-1411/1000-411	100	5,2 x 32,9 x 69,9 mm / 0.205 x 1.3 x 2.75 inch	U <sub>N</sub> 250 V; U <sub>RM</sub> 1000 V; 1N4007 – 0.5 A continuous current
		4-conductor diode terminal block; with 1N4007 diode	○ gray	2002-1411/1000-410	100	5,2 x 32,9 x 69,9 mm / 0.205 x 1.3 x 2.75 inch	U <sub>N</sub> 250 V; U <sub>RM</sub> 1000 V; 1N4007 – 0.5 A continuous current
		4-conductor LED terminal block; with red LED	○ gray	2002-1421/1000-434	100	5,2 x 32,9 x 69,9 mm / 0.205 x 1.3 x 2.75 inch	24 VDC; I <sub>f</sub> 0.025 (max.)
		4-conductor LED terminal block; with red LED	○ gray	2002-1421/1000-413	100	5,2 x 32,9 x 69,9 mm / 0.205 x 1.3 x 2.75 inch	24 VDC; I <sub>f</sub> 0.025 (max.)
		End and intermediate plate; 0.8 mm thick	● orange	2002-1492	25	0,8 x 33 x 70 mm /	
			○ gray	2002-1491	25	0.03 x 1.3 x 2.76 inch	

Conductor range: 0.25 ... 4 mm<sup>2</sup> "s+f-st"; Push-in termination: 1 ... 4 mm<sup>2</sup> "s" and 1 ... 2.5 mm<sup>2</sup> "insulated ferrules; 12 mm"; 22 ... 12 AWG; Strip length: 10 ... 12 mm / 0.39 ... 0.47 inch

Accessories: see pages 36 ... 38.

Marking: WMB/WMB Inline/Marking strips

Suitable operating tool: see page 39

# WAGO Diode Terminal Block TOPJOB® S – 2004 Series

## 4 (6) mm<sup>2</sup>

1

Image	Circuit diagram	Description	Color	Item No.	PU	Dimensions (W x H x D)	Electrical Data
<b>2-conductor diode terminal block</b>							
		2-conductor diode terminal block; with 1N5408 diode	○ gray	2004-1211/1000-401	50	6,2 x 32,9 x 52,3 mm / 0,244 x 1.3 x 2.06 inch	U <sub>N</sub> 250 V; U <sub>RM</sub> 1000 V; 1N5408 – 1.5 A continuous current
		2-conductor diode terminal block; with 1N5408 diode	○ gray	2004-1211/1000-400	50	6,2 x 32,9 x 52,3 mm / 0,244 x 1.3 x 2.06 inch	U <sub>N</sub> 250 V; U <sub>RM</sub> 1000 V; 1N5408 – 1.5 A continuous current
		End and intermediate plate; 1 mm thick	● orange	2004-1292	25	1 x 32,9 x 52,5 mm / 0,04 x 1.3 x 2.07 inch	
			○ gray	2004-1291	25		
<b>3-conductor diode terminal block/3-conductor LED terminal block</b>							
		3-conductor diode terminal block; with 1N5408 diode	○ gray	2004-1311/1000-401	50	6,2 x 32,9 x 65,5 mm / 0,244 x 1.3 x 2.58 inch	U <sub>N</sub> 250 V; U <sub>RM</sub> 1000 V; 1N5408 – 1.5 A continuous current
		3-conductor diode terminal block; with 1N5408 diode	○ gray	2004-1311/1000-400	50	6,2 x 32,9 x 65,5 mm / 0,244 x 1.3 x 2.58 inch	U <sub>N</sub> 250 V; U <sub>RM</sub> 1000 V; 1N5408 – 1.5 A continuous current
		End and intermediate plate; 1 mm thick	● orange	2004-1392	25	1 x 32,9 x 65,5 mm / 0,04 x 1.3 x 2.56 inch	
			○ gray	2004-1391	25		
<b>4-conductor diode terminal block/4-conductor LED terminal block</b>							
		4-conductor diode terminal block; with 1N5408 diode	○ gray	2004-1411/1000-401	50	6,2 x 32,9 x 78,7 mm / 0,244 x 1.3 x 3.1 inch	U <sub>N</sub> 250 V; U <sub>RM</sub> 1000 V; 1N5408 – 1.5 A continuous current
		4-conductor diode terminal block; with 1N5408 diode	○ gray	2004-1411/1000-400	50	6,2 x 32,9 x 78,7 mm / 0,244 x 1.3 x 3.1 inch	U <sub>N</sub> 250 V; U <sub>RM</sub> 1000 V; 1N5408 – 1.5 A continuous current
		End and intermediate plate; 1 mm thick	● orange	2004-1492	25	1 x 32,9 x 79 mm / 0,04 x 1.3 x 3.11 inch	
			○ gray	2004-1491	25		

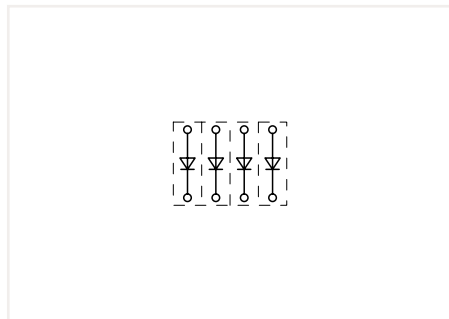

Open diode gates can be created using the following terminal blocks: 2001-1211/1000-410 or 2001-1211/1000-411



These diode terminal blocks have been specially developed for custom diode circuits, such as lamp test and collective fault signal circuits.



Using LED terminal blocks, monitoring units can be designed, e.g., for control and operating circuits.

Conductor range: 0.5 ... 6 mm<sup>2</sup> "s+f-st"; Push-in termination: 1.5 ... 6 mm<sup>2</sup> "s" and 1.5 ... 4 mm<sup>2</sup> "insulated ferrules; 12 mm"; 20 ... 10 AWG; Strip length: 11 ... 13 mm / 0.43 ... 0.51 inch

Accessories: see pages 36 ... 38.  
Marking: WMB/WMB Inline/Marking strips  
Suitable operating tool: see page 39

## WAGO Double-Deck Diode Terminal Block and LED Terminal Block TOPJOB® S – 2002 Series 2.5 (4) mm<sup>2</sup>

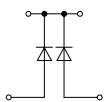
Image	Circuit diagram	Description	Color	Item No.	PU	Dimensions (W x H x D)	Electrical Data
<b>Double-deck diode terminal block</b>							
		Double-deck diode terminal block; with 1N4007 diode	○ gray	2002-2211/1000-410	50	5,2 x 51.7 x 69,7 mm / 0.205 x 2.03 x 2.74 inch	U <sub>N</sub> 250 V; U <sub>RM</sub> 1000 V; 1N4007 – 0.5 A continu- ous current
		Double-deck diode terminal block; with 1N4007 diode	○ gray	2002-2211/1000-411	50	5,2 x 51.7 x 69,7 mm / 0.205 x 2.03 x 2.74 inch	U <sub>N</sub> 250 V; U <sub>RM</sub> 1000 V; 1N4007 – 0.5 A continu- ous current
		Double-deck diode terminal block; with two 1N4007 diodes	○ gray	2002-2213/1000-487	50	5,2 x 51.7 x 69,7 mm / 0.205 x 2.03 x 2.74 inch	U <sub>N</sub> 250 V; U <sub>RM</sub> 1000 V; 1N4007 – 0.5 A continu- ous current
		Double-deck diode terminal block; with two 1N4007 diodes	○ gray	2002-2213/1000-488	50	5,2 x 51.7 x 69,7 mm / 0.205 x 2.03 x 2.74 inch	U <sub>N</sub> 250 V; U <sub>RM</sub> 1000 V; 1N4007 – 0.5 A continu- ous current
		Double-deck diode terminal block; with two 1N4007 diodes	○ gray	2002-2214/1000-492	50	5,2 x 51.7 x 69,7 mm / 0.205 x 2.03 x 2.74 inch	U <sub>N</sub> 250 V; U <sub>RM</sub> 1000 V; 1N4007 – 0.5 A continu- ous current
		Double-deck diode terminal block; with two 1N4007 diodes	○ gray	2002-2214/1000-491	50	5,2 x 51.7 x 69,7 mm / 0.205 x 2.03 x 2.74 inch	U <sub>N</sub> 250 V; U <sub>RM</sub> 1000 V; 1N4007 – 0.5 A continu- ous current
		Double-deck diode terminal block; with two 1N4007 diodes	○ gray	2002-2214/1000-489	50	5,2 x 51.7 x 69,7 mm / 0.205 x 2.03 x 2.74 inch	U <sub>N</sub> 250 V; U <sub>RM</sub> 1000 V; 1N4007 – 0.5 A continu- ous current
		Double-deck diode terminal block; with two 1N4007 diodes	○ gray	2002-2214/1000-490	50	5,2 x 51.7 x 69,7 mm / 0.205 x 2.03 x 2.74 inch	U <sub>N</sub> 250 V; U <sub>RM</sub> 1000 V; 1N4007 – 0.5 A continu- ous current
		Double-deck diode terminal block; with two 1N4007 diodes	○ gray	2002-2214/1000-980	50	5,2 x 51.7 x 69,7 mm / 0.205 x 2.03 x 2.74 inch	U <sub>N</sub> 250 V; U <sub>RM</sub> 1000 V; 1N4007 – 0.5 A continu- ous current
<b>Double-deck LED terminal block</b>							
		Double-deck LED terminal block; with red LED	○ gray	2002-2221/1000-434	50	5,2 x 51.7 x 69,7 mm / 0.205 x 2.03 x 2.74 inch	24 VDC; I <sub>f</sub> 0.025 (max.)
		Double-deck LED terminal block; with red LED	○ gray	2002-2221/1000-413	50	5,2 x 51.7 x 69,7 mm / 0.205 x 2.03 x 2.74 inch	24 VDC; I <sub>f</sub> 0.025 (max.)
		End and intermediate plate; 0.7 mm thick	● orange ○ gray	2002-2292 2002-2291	25 25	0,7 x 51.7 x 70 mm / 0.03 x 2.03 x 2.76 inch	
		These end plates are also suitable for double-deck diode terminal blocks!					

Conductor range: 0.25 ... 4 mm<sup>2</sup> "s+f-st"; Push-in  
termination: 1 ... 4 mm<sup>2</sup> "s" and 1 ... 2.5 mm<sup>2</sup> "insulated  
ferrules; 12 mm"; 22 ... 12 AWG;  
Strip length: 10 ... 12 mm / 0.39 ... 0.47 inch

Accessories: see pages 36 ... 38.  
Marking: WMB/WMB Inline/Marking strips  
Suitable operating tool: see page 39

# WAGO Triple-Deck Diode Terminal Block and LED Terminal Block TOPJOB® S – 2002 Series

## 2.5 (4) mm<sup>2</sup>

1

Image	Circuit diagram	Description	Color	Item No.	PU	Dimensions (W x H x D)	Electrical Data
<b>Triple-deck diode terminal block</b>							
		Triple-deck diode terminal block; with 1N4007 diode	gray	2002-3211/1000-410	50	5,2 x 69,5 x 93,3 mm / 0.205 x 2.74 x 3.67 inch	U <sub>N</sub> 250 V; U <sub>RM</sub> 1000 V; 1N4007 – 0.5 A continuous current
		Triple-deck diode terminal block; with 1N4007 diode	gray	2002-3211/1000-411	50	5,2 x 69,5 x 93,3 mm / 0.205 x 2.74 x 3.67 inch	U <sub>N</sub> 250 V; U <sub>RM</sub> 1000 V; 1N4007 – 0.5 A continuous current
		Triple-deck diode terminal block; with 1N4007 diode	gray	2002-3211/1000-675	50	5,2 x 69,5 x 93,3 mm / 0.205 x 2.74 x 3.67 inch	U <sub>N</sub> 250 V; U <sub>RM</sub> 1000 V; 1N4007 – 0.5 A continuous current
		Triple-deck diode terminal block; with 1N4007 diode	gray	2002-3211/1000-676	50	5,2 x 69,5 x 93,3 mm / 0.205 x 2.74 x 3.67 inch	U <sub>N</sub> 250 V; U <sub>RM</sub> 1000 V; 1N4007 – 0.5 A continuous current
		Triple-deck diode terminal block; with three 1N4007 diodes	gray	2002-3212/1000-673	50	5,2 x 69,5 x 93,3 mm / 0.205 x 2.74 x 3.67 inch	U <sub>N</sub> 250 V; U <sub>RM</sub> 1000 V; 1N4007 – 0.5 A continuous current
		Triple-deck diode terminal block; with three 1N4007 diodes	gray	2002-3212/1000-674	50	5,2 x 69,5 x 93,3 mm / 0.205 x 2.74 x 3.67 inch	U <sub>N</sub> 250 V; U <sub>RM</sub> 1000 V; 1N4007 – 0.5 A continuous current
<b>Triple-deck LED terminal block</b>							
		Triple-deck LED terminal block; with red LED	gray	2002-3221/1000-434	50	5,2 x 69,5 x 93,3 mm / 0.205 x 2.74 x 3.67 inch	24 VDC; I <sub>F</sub> 0.025 (max.)
		Triple-deck LED terminal block; with red LED	gray	2002-3221/1000-413	50	5,2 x 69,5 x 93,3 mm / 0.205 x 2.74 x 3.67 inch	24 VDC; I <sub>F</sub> 0.025 (max.)
		End and intermediate plate; 0.8 mm thick	orange gray	2002-3292 2002-3291	25 25	0,8 x 69,5 x 93,3 mm / 0.03 x 2.74 x 3.67 inch	
		These end plates are also suitable for triple-deck diode terminal blocks!					



Double- and triple-deck LED terminal blocks: Using LED terminal blocks, monitoring units can be designed, e.g., for control and operating circuits.



Triple-deck diode terminal blocks were specifically developed for custom diode circuits, such as lamp test and collective fault signal circuits. These terminal blocks provide high-density wiring in a width of just 5.2 mm. Push-in type jumper bars provide additional options for custom circuit design.

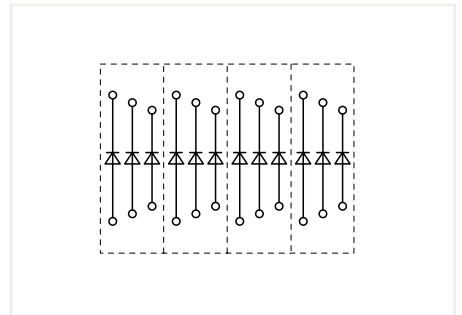

Open diode gates can be created and connected individually using the following terminal blocks: 2002-3212/1000-673 or 2002-3212/1000-674

Using push-in type jumper bars, individual decks can be turned into polarized diode gates.

Conductor range: 0.25 ... 4 mm<sup>2</sup> "s+f-st"; Push-in termination: 1 ... 4 mm<sup>2</sup> "s" and 1 ... 2.5 mm<sup>2</sup> "insulated ferrules; 12 mm"; 22 ... 12 AWG; Strip length: 10 ... 12 mm / 0.39 ... 0.47 inch

Accessories: see pages 36 ... 38.  
Marking: WMB/WMB Inline/Marking strips  
Suitable operating tool: see page 39

# WAGO Diode and LED Terminal Blocks TOPJOB® S

## Circuit Configuration Examples

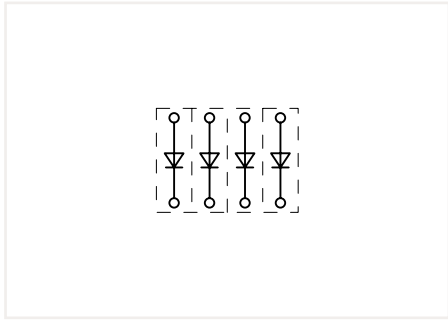

Open diode gates can be created using the following terminal blocks:

- 2001-1211/1000-410 or 2001-1211/1000-411
- 2002-1211/1000-410 or 2002-1211/1000-411
- 2004-1211/1000-410 or 2004-1211/1000-411

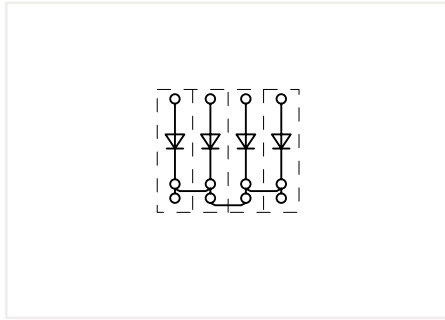

Polarized diode gates with a common cathode can be created using the following terminal blocks:

- 2001-1311/1000-410 or 2001-1311/1000-411
- 2002-1311/1000-410 or 2002-1311/1000-411
- 2004-1311/1000-410 or 2004-1311/1000-411

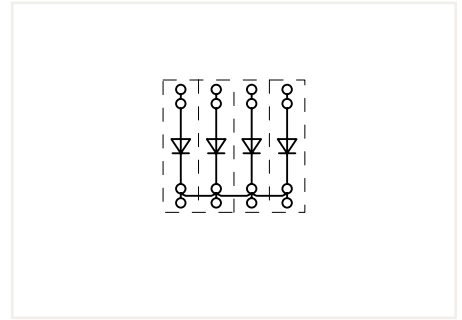

Polarized diode gates with a common cathode can be created using the following terminal blocks:

- 2001-1411/1000-410 or 2001-1411/1000-411
- 2002-1411/1000-410 or 2002-1411/1000-411
- 2004-1411/1000-410 or 2004-1411/1000-411

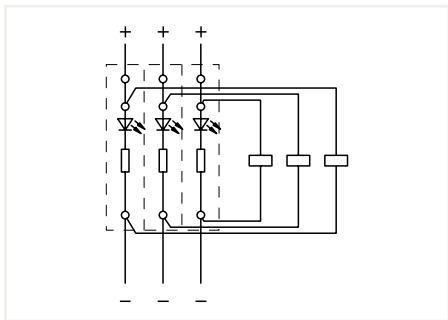

Circuit-related voltage indications can be created using the following terminal blocks:

- 2001-1321/1000-434 or 2001-1321/1000-413
- 2002-1321/1000-434 or 2002-1321/1000-413

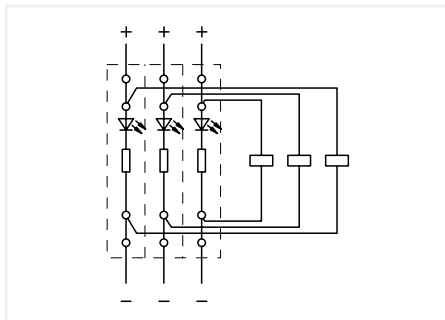

Circuit-related voltage indications can be created using the following terminal blocks:

- 2001-1421/1000-434 or 2001-1421/1000-413
- 2002-1421/1000-434 or 2002-1421/1000-413

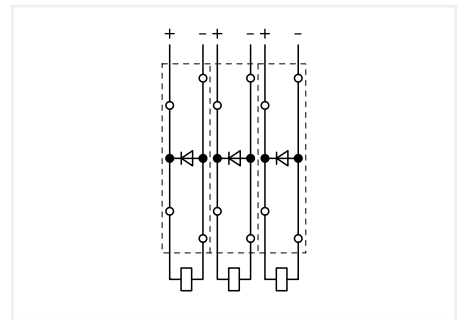

Open diode gates can be created using the following terminal blocks:

- 2002-2211/1000-410 or 2002-2211/1000-411

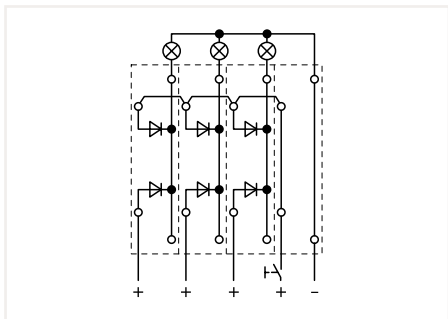

Polarized diode gates with a common cathode can be created using the following terminal blocks:

- 2002-2213/1000-487 or 2002-2213/1000-488

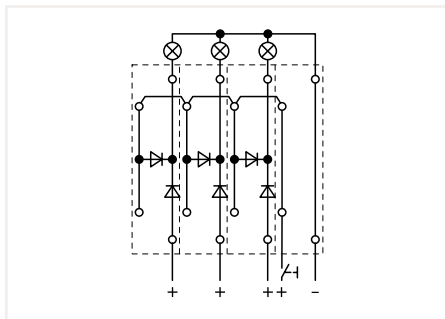

Lamp test circuits can be created using the following terminal blocks:

- 2002-2214/1000-492 or 2002-2214/1000-491

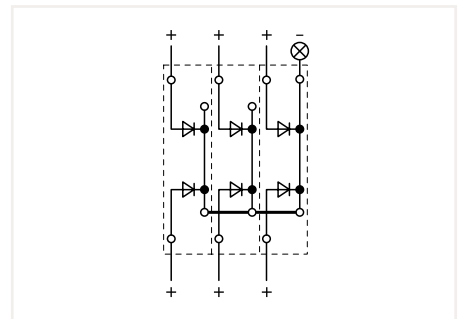

Polarized diode gates with a common cathode can be created using the following terminal blocks:

- 2002-2214/1000-489 or 2002-2214/1000-490

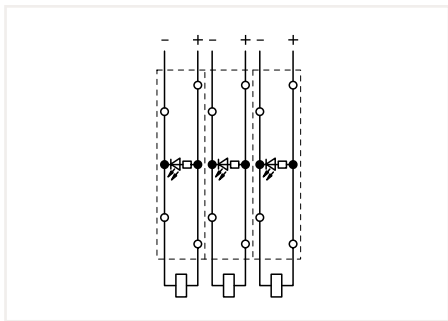

Circuit-related voltage indications can be created using the following terminal blocks:

- 2002-2221/1000-434 or 2002-2221/1000-413

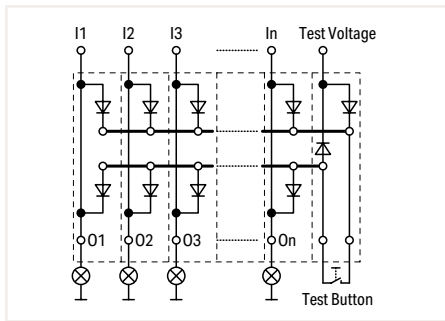

AC lamp test circuits can be created using the following terminal blocks:

- 2002-2214/1000-980 and 2002-2201 for the button wiring



Using LED terminal blocks, monitoring units can be designed, e.g., for control and operating circuits.

# WAGO Sensor Terminal Block TOPJOB® S – 2000 Series

## 1 (1,5) mm<sup>2</sup>

Image	Circuit Diagram	Description	Color	Item No.	PU	Dimensions (W x H x D)	Electrical Data
<b>3-conductor sensor terminal block/sensor supply terminal block</b>							
		3-conductor sensor terminal block	gray	2000-5311	50	7 x 52,4 x 81,1 mm / 0,276 x 2,06 x 3,19 inch	250 V/4 kV/3 ①; I <sub>N</sub> 13,5 A; 300 V, 10 A
		3-conductor sensor terminal block; yellow LED; for PNP (high-side) switching sensors	gray	2000-5311/1102-950	50	7 x 52,4 x 81,1 mm / 0,276 x 2,06 x 3,19 inch	24 VDC; I <sub>N</sub> 13,5 A
		3-conductor sensor terminal block; yellow LED; for NPN (low-side) switching sensors	gray	2000-5311/1101-951	50	7 x 52,4 x 81,1 mm / 0,276 x 2,06 x 3,19 inch	24 VDC; I <sub>N</sub> 13,5 A
		3-conductor sensor LED supply terminal block; green LED; 24 VDC	orange	2000-5372/1102-953	15	7 x 52,4 x 81,1 mm / 0,276 x 2,06 x 3,19 inch	250 V/4 kV/3 ①; I <sub>N</sub> 13,5 A; 300 V, 10 A
		3-conductor sensor supply terminal block; max. 250 V; internally commoned	orange	2000-5372	15	7 x 52,4 x 81,1 mm / 0,276 x 2,06 x 3,19 inch	250 V/4 kV/3 ①; I <sub>N</sub> 13,5 A; 300 V, 10 A
		3-conductor sensor LED supply terminal block; green LED; 24 VDC control panel side: 2.5 (4) mm <sup>2</sup> ; max. 28 A	orange	2000-5352/1102-953	15	7 x 49,4 x 81,1 mm / 0,276 x 1,96 x 3,19 inch	24 VDC; I <sub>N</sub> 13,5 A
		3-conductor sensor supply terminal block; max. 250 V; control panel side: 2.5 (4) mm <sup>2</sup> ; max. 28 A	orange	2000-5352	15	7 x 49,4 x 81,1 mm / 0,276 x 1,96 x 3,19 inch	24 VDC; I <sub>N</sub> 13,5 A
		End and intermediate plate; 1 mm thick	gray	2000-5391	25	7 x 49,4 x 81,1 mm / 0,276 x 1,96 x 3,19 inch	



**Commoning (signal level):**  
Commoning the signal level with push-in type jumper bars (2000 Series). Models with an LED can only be commoned in one jumper slot.  
Test plug adapters can be used in all jumper slots!



**Commoning (potential level):**  
Commoning potential levels via push-in type jumper bars (2000 Series).



**Ground commoning:**  
For sensor and actuator terminal blocks without ground connection to the DIN-rail, the ground connection can be performed by commoning to the terminal block with a ground foot.



**Supply:**  
Orange supply terminal block of same profile with a power supply option from both the cabinet and sensor sides



**Upper level: two independent signal pathways**



**Potential levels: two adjacent commoning options on a current bar**

# WAGO Sensor Terminal Block TOPJOB® S – 2000 Series

## 1 (1,5) mm<sup>2</sup>

Image	Circuit Diagram	Description	Color	Item No.	PU	Dimensions (W x H x D)	Electrical Data
<b>4-conductor sensor terminal block/sensor supply terminal block</b>							
		4-conductor sensor terminal block; with ground connection	gray	2000-5417	50	7 x 52,4 x 97,3 mm / 0,276 x 2,06 x 3,83 inch	250 V/4 kV/3 ①; I <sub>n</sub> 13,5 A; 300 V, 10 A
		4-conductor sensor LED terminal block; yellow LED; for PNP (high-side) switching sensors; with ground connection	gray	2000-5417/1102-950	50	7 x 52,4 x 97,3 mm / 0,276 x 2,06 x 3,83 inch	24 VDC; I <sub>n</sub> 13,5 A
		4-conductor sensor terminal block; yellow LED; for NPN (low-side) switching sensors; with ground connection	gray	2000-5417/1101-951	50	7 x 52,4 x 97,3 mm / 0,276 x 2,06 x 3,83 inch	24 VDC; I <sub>n</sub> 13,5 A
		4-conductor sensor terminal block; with ground via push-in type jumper bar	gray	2000-5410	50	7 x 52,4 x 97,3 mm / 0,276 x 2,06 x 3,83 inch	250 V/4 kV/3 ①; I <sub>n</sub> 13,5 A; 300 V, 10 A
		4-conductor sensor LED terminal block; yellow LED; for PNP (high-side) switching sensors; with ground via push-in type jumper bar	gray	2000-5410/1102-950	50	7 x 52,4 x 97,3 mm / 0,276 x 2,06 x 3,83 inch	24 VDC; I <sub>n</sub> 13,5 A
		4-conductor sensor LED terminal block; yellow LED; for NPN (low-side) switching sensors; with ground via push-in type jumper bar	gray	2000-5410/1101-951	50	7 x 52,4 x 97,3 mm / 0,276 x 2,06 x 3,83 inch	24 VDC; I <sub>n</sub> 13,5 A
		4-conductor sensor LED supply terminal block; green LED; 24 VDC; with ground connection	orange	2000-5477/1102-953	15	7 x 52,5 x 97,3 mm / 0,276 x 2,06 x 3,83 inch	250 V/4 kV/3 ①; I <sub>n</sub> 13,5 A; 300 V, 10 A
		4-conductor sensor supply terminal block; max. 250 V; internally commoned; with ground connection	orange	2000-5477	15	7 x 52,5 x 97,3 mm / 0,276 x 2,06 x 3,83 inch	250 V/4 kV/3 ①; I <sub>n</sub> 13,5 A; 300 V, 10 A
		3-conductor sensor LED supply terminal block; green LED; 24 VDC control panel side; 2.5 (4) mm <sup>2</sup> ; max. 28 A	orange	2000-5457/1102-953	15	7 x 49,4 x 97,3 mm / 0,276 x 1,96 x 3,83 inch	24 VDC; I <sub>n</sub> 13,5 A
		3-conductor sensor supply terminal block; max. 250 V; with ground connection; control panel side; 2.5 (4) mm <sup>2</sup> ; max. 28 A	orange	2000-5457	15	7 x 49,4 x 97,3 mm / 0,276 x 1,96 x 3,83 inch	24 VDC; I <sub>n</sub> 13,5 A
		End and intermediate plate; 1 mm thick	gray	2000-5491	25	7 x 49,4 x 97,3 mm / 0,276 x 1,96 x 3,83 inch	

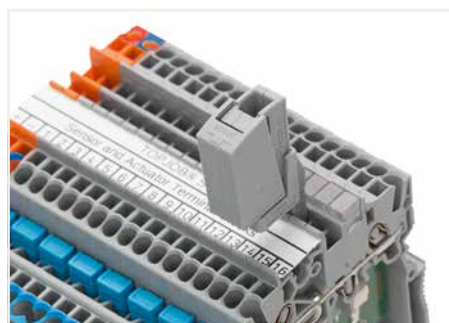

Testing via testing tap (2009-182) (up to max. 42 V).

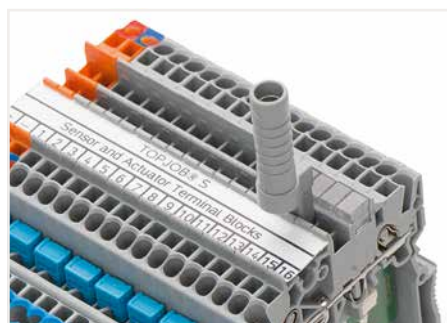

Testing via test plug adapter (2009-174) (up to max. 42 V).

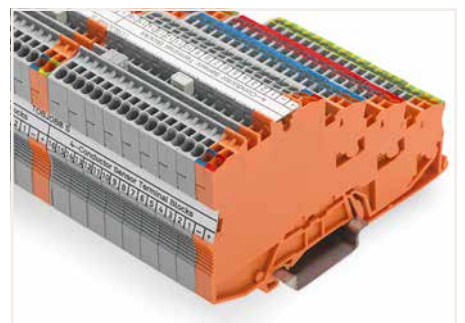

Labeling via marking strips (2009-110) – from the top or the side.

Conductor range: 0.14 ... 1.5 mm<sup>2</sup> "s+f-st"; Push-in termination: 0.5 ... 1.5 mm<sup>2</sup> "s" and 0.5 ... 0.75 mm<sup>2</sup> "insulated ferrules; 12 mm"; 24 ... 16 AWG; Strip length: 9 ... 11 mm / 0.35 ... 0.43 inch

① 250 V = rated voltage  
4 kV = rated impulse voltage  
3 = pollution degree

Accessories: see page 36 ... 38.

Marking: WMB/WMB Inline/Marking strips

Suitable operating tool: see page 39

# WAGO Actuator Terminal Block TOPJOB® S – 2000 Series

## 1 (1,5) mm<sup>2</sup>

Image	Circuit Diagram	Description	Color	Item No.	PU	Dimensions (W x H x D)	Electrical Data
<b>3-conductor actuator terminal block/actuator supply terminal block</b>							
		3-conductor actuator terminal block; for PNP (high-side) switching actuators; with ground connection	gray	2000-5317/102-000	50	7 x 52,4 x 81,1 mm / 0,276 x 2,06 x 3,19 inch	250 V/4 kV/3 ①; I <sub>N</sub> 13,5 A; 300 V, 10 A
		3-conductor actuator terminal block; for NPN (low-side) switching actuators; with ground connection	gray	2000-5317/101-000	50	7 x 52,4 x 81,1 mm / 0,276 x 2,06 x 3,19 inch	250 V/4 kV/3 ①; I <sub>N</sub> 13,5 A; 300 V, 10 A
		3-conductor actuator terminal block; yellow LED; for PNP (high-side) switching actuators; with ground connection	gray	2000-5317/1102-950	50	7 x 52,4 x 81,1 mm / 0,276 x 2,06 x 3,19 inch	24 VDC; I <sub>N</sub> 13,5 A
		3-conductor actuator terminal block; yellow LED; for NPN (low-side) switching actuators; with ground connection	gray	2000-5317/1101-951	50	7 x 52,4 x 81,1 mm / 0,276 x 2,06 x 3,19 inch	24 VDC; I <sub>N</sub> 13,5 A
		3-conductor actuator terminal block; for PNP (high-side) switching actuators; with ground connection via push-in type jumper bar	gray	2000-5310/102-000	50	7 x 52,4 x 81,1 mm / 0,276 x 2,06 x 3,19 inch	250 V/4 kV/3 ①; I <sub>N</sub> 13,5 A; 300 V, 10 A
		3-conductor actuator terminal block; for NPN (low-side) switching actuators; with ground connection via push-in type jumper bar	gray	2000-5310/101-000	50	7 x 52,4 x 81,1 mm / 0,276 x 2,06 x 3,19 inch	250 V/4 kV/3 ①; I <sub>N</sub> 13,5 A; 300 V, 10 A
		3-conductor actuator terminal block; yellow LED; for PNP (high-side) switching actuators; with ground via push-in type jumper bar	gray	2000-5310/1102-950	50	7 x 52,4 x 81,1 mm / 0,276 x 2,06 x 3,19 inch	24 VDC; I <sub>N</sub> 13,5 A
		3-conductor actuator terminal block; yellow LED; for NPN (low-side) switching actuators; with ground connection via push-in type jumper bar	gray	2000-5310/1101-951	50	7 x 52,4 x 81,1 mm / 0,276 x 2,06 x 3,19 inch	24 VDC; I <sub>N</sub> 13,5 A
		3-conductor actuator supply terminal block; max. 250 V; for PNP (high-side) switching actuators; with ground connection; internally commoned	orange	2000-5377/102-000	15	7 x 52,4 x 81,1 mm / 0,276 x 2,06 x 3,19 inch	250 V/4 kV/3 ①; I <sub>N</sub> 13,5 A; 300 V, 10 A
		3-conductor actuator supply terminal block; max. 250 V; for NPN (low-side) switching actuators; with ground connection	orange	2000-5377/101-000	15	7 x 52,4 x 81,1 mm / 0,276 x 2,06 x 3,19 inch	250 V/4 kV/3 ①; I <sub>N</sub> 13,5 A; 300 V, 10 A
		3-conductor actuator supply terminal block; max. 250 V; control panel side: 2.5 (4) mm <sup>2</sup> ; max. 28 A; for PNP (high-side) switching actuators; with ground connection	orange	2000-5357/102-000	15	7 x 49,4 x 81,1 mm / 0,276 x 1,96 x 3,19 inch	24 VDC; I <sub>N</sub> 13,5 A
		3-conductor actuator supply terminal block; max. 250 V; control panel side: 2.5 (4) mm <sup>2</sup> ; max. 28 A; for NPN (low-side) switching actuators; with ground connection	orange	2000-5357/101-000	15	7 x 49,4 x 81,1 mm / 0,276 x 1,96 x 3,19 inch	24 VDC; I <sub>N</sub> 13,5 A
		End and intermediate plate; 1 mm thick	gray	2000-5391	25	7 x 49,4 x 81,1 mm / 0,276 x 1,96 x 3,19 inch	



Note: For suitable female plug, see page 66.



Insert coding pin into the corresponding slot and twist it off.











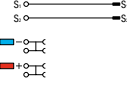

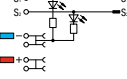

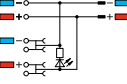

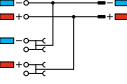

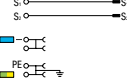

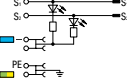

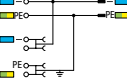

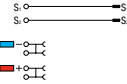
Remove the coding finger using a cutting tool.

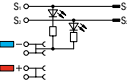

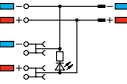
# WAGO Sensor and Actuator Terminal Block TOPJOB® S – 2020 Series

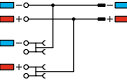
## 1 (1,5) mm<sup>2</sup>

Image	Circuit Diagram	Description	Color	Item No.	PU	Dimensions (W x H x D)	Electrical Data
<b>3-conductor sensor terminal block/sensor supply terminal block/actuator terminal block/actuator supply terminal block</b>							
		3-conductor sensor terminal block; with pluggable signal level	gray	2020-5311	50	7 x 52,4 x 81,1 mm / 0,276 x 2,06 x 3,19 inch	250 V/4 kV/3 ①; I <sub>N</sub> 13,5 A; 300 V, 10 A
		3-conductor sensor terminal block; yellow LED; for PNP (high-side) switching sensors; with pluggable signal level	gray	2020-5311/1102-950	50	7 x 52,4 x 81,1 mm / 0,276 x 2,06 x 3,19 inch	24 VDC; I <sub>N</sub> 13,5 A
		3-conductor sensor LED supply terminal block; green LED; 24 VDC; with pluggable signal level	orange	2020-5372/1102-953	15	7 x 52,4 x 81,1 mm / 0,276 x 2,06 x 3,19 inch	250 V/4 kV/3 ①; I <sub>N</sub> 13,5 A; 300 V, 10 A
		3-conductor sensor supply terminal block; max. 250 V; internally commoned; with pluggable signal level	orange	2020-5372	15	7 x 52,4 x 81,1 mm / 0,276 x 2,06 x 3,19 inch	24 VDC; I <sub>N</sub> 13,5 A
		3-conductor actuator terminal block; for PNP (high-side) switching actuators; with ground connection; with pluggable signal level	gray	2020-5317/102-000	50	7 x 52,4 x 81,1 mm / 0,276 x 2,06 x 3,19 inch	250 V/4 kV/3 ①; I <sub>N</sub> 13,5 A; 300 V, 10 A
		3-conductor actuator terminal block; yellow LED; for PNP (high-side) switching actuators; with ground connection; with pluggable signal level	gray	2020-5317/1102-950	50	7 x 52,4 x 81,1 mm / 0,276 x 2,06 x 3,19 inch	24 VDC; I <sub>N</sub> 13,5 A
		3-conductor actuator supply terminal block; for PNP (high-side) switching actuators; with ground connection; internally commoned; with pluggable signal level	orange	2020-5377/102-000	15	7 x 52,4 x 81,1 mm / 0,276 x 2,06 x 3,19 inch	250 V/4 kV/3 ①; I <sub>N</sub> 13,5 A; 300 V, 10 A
		End and intermediate plate; 1 mm thick	gray	2020-5391	25	7 x 52,4 x 81,1 mm / 0,276 x 2,06 x 3,19 inch	
<b>4-conductor sensor terminal block/sensor supply terminal block</b>							
		4-conductor sensor terminal block; with ground connection; with pluggable signal level	gray	2020-5417	50	7 x 52,4 x 97,3 mm / 0,276 x 2,06 x 3,83 inch	250 V/4 kV/3 ①; I <sub>N</sub> 13,5 A; 300 V, 10 A
		4-conductor sensor terminal block; yellow LED; for PNP (high-side) switching sensors; with ground connection; with pluggable signal level	gray	2020-5417/1102-950	50	7 x 52,4 x 97,3 mm / 0,276 x 2,06 x 3,83 inch	24 VDC; I <sub>N</sub> 13,5 A
		4-conductor sensor LED supply terminal block; green LED; 24 VDC; with ground connection; with pluggable signal level	orange	2020-5477/1102-953	15	7 x 52,4 x 97,3 mm / 0,276 x 2,06 x 3,83 inch	250 V/4 kV/3 ①; I <sub>N</sub> 13,5 A; 300 V, 10 A
		4-conductor sensor supply terminal block; max. 250 V; internally commoned; with ground connection; with pluggable signal level	orange	2020-5477	15	7 x 52,4 x 97,3 mm / 0,276 x 2,06 x 3,83 inch	24 VDC; I <sub>N</sub> 13,5 A
		End and intermediate plate; 1 mm thick	gray	2020-5491	25	7 x 52,4 x 97,3 mm / 0,276 x 2,06 x 3,83 inch	

Conductor range: 0.14 ... 1.5 mm<sup>2</sup> "s+f-st"; Push-in termination: 0.5 ... 1.5 mm<sup>2</sup> "s" and 0.5 ... 0.75 mm<sup>2</sup> "insulated ferrules; 12 mm"; 24 ... 16 AWG; Strip length: 9 ... 11 mm / 0.35 ... 0.43 inch

① 250 V = rated voltage  
4 kV = rated impulse voltage  
3 = pollution degree

Accessories: see page 36 ... 38.

Marking: WMB/WMB Inline/Marking strips

Suitable operating tool: see page 39

# WAGO X-COM®S-SYSTEM-MINI; 2020 Series

## WAGO X-COM®S-SYSTEM; 2022 Series

### Description and Installation

1

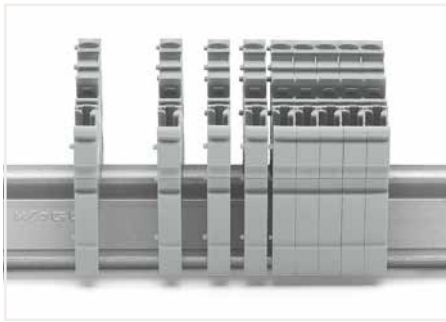

Snap individual carrier terminal blocks onto the DIN-rail and slide together.



Open the assembly by laterally sliding a block via operating tool (3.5 x 0.5 mm blade).

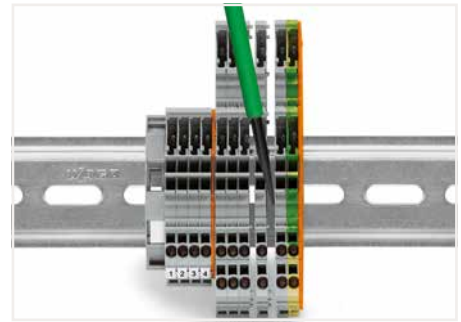

Separate terminal block assembly and slide individual terminal blocks laterally using an operating tool.

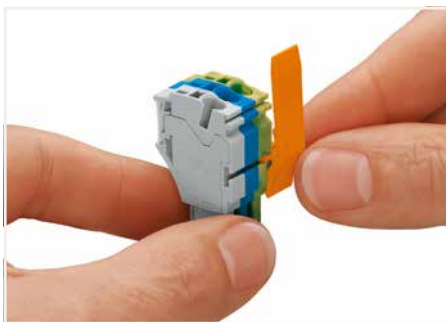

Slide the locking lever into position.

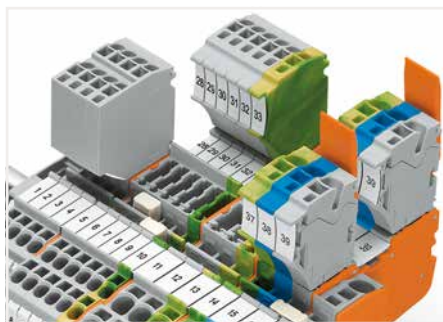

Female plugs can be individually locked.

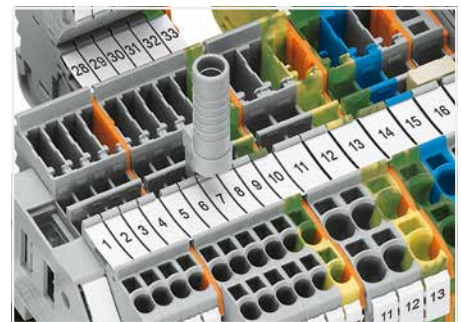

Test plug adapter (2009-174) for 4 mm test plugs or banana plugs – also suitable for X-COM®S-SYSTEM-MINI Terminal Blocks.

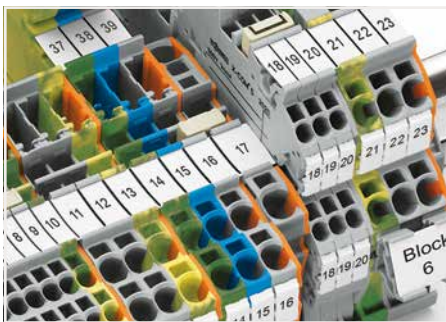

Commoning X-COM®S-SYSTEM Terminal Blocks using jumpers for TOPJOB® S Terminal Blocks. An end plate provides connection to TOPJOB® S Terminal Blocks. 2020 and 2022 Series Terminal Blocks are combinable. Jumper slots are on the same level for both series.

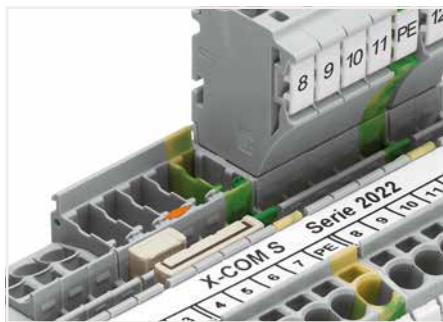

Pairing push-in comb style jumpers.

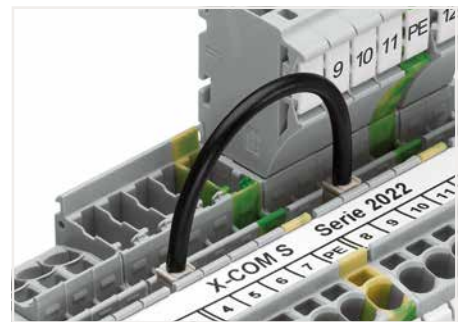

Commoning with push-in type wire jumper.

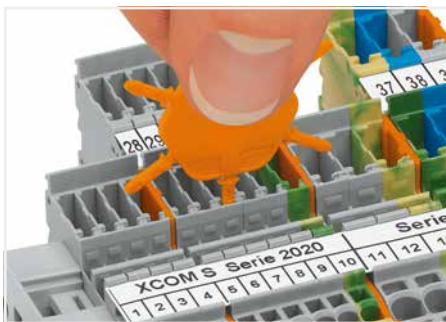

Insert coding pin into the corresponding slot and twist it off.





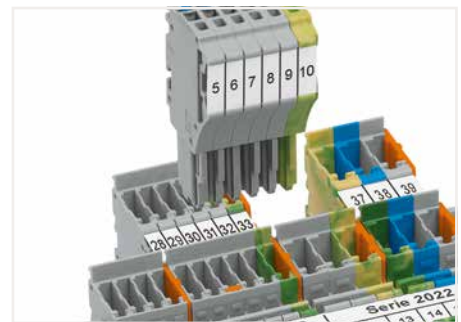









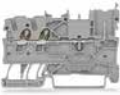

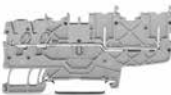
Coding a female plug: remove coding finger using a suitable tool.



Insert coded female connector into X-COM®S-SYSTEM terminal block assembly.

# WAGO Carrier Terminal Block and WAGO Double-Deck Carrier Terminal Block X-COM®S-SYSTEM-MINI – 2020 Series

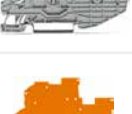
## 1 (1,5) mm<sup>2</sup>

Image	Description	Color	Item No.	PU	Potential Marking	Dimensions (W x H x D)	Electrical Data
<b>1-conductor/1-pin carrier terminal block</b>							
	Carrier terminal block	gray	2020-1201	50		3,5 x 32,5 x 48,5 mm/ 0.14 x 1.3 x 1.91 inch	500 V/6 kV/3 ①; I <sub>N</sub> 13,5 A; 300 V, 10 A ②; 300 V, 10 A ③
	Carrier terminal block	blue	2020-1204	50			
	Ground carrier terminal block	green-yellow	2020-1207	50			
	End and intermediate plate; 1 mm thick	orange	2020-1292	25		1 x 31,6 x 48,1 mm/ 0.04 x 1.24 x 1.9 inch	
	End and intermediate plate; 1 mm thick	gray	2020-1291	25			
<b>2-conductor/1-pin carrier terminal block</b>							
	Carrier terminal block	gray	2020-1301	50		3,5 x 32,5 x 58,2 mm/ 0.14 x 1.3 x 2.78 inch	500 V/6 kV/3 ①; I <sub>N</sub> 13,5 A; 300 V, 10 A ②; 300 V, 10 A ③
	Carrier terminal block	blue	2020-1304	50			
	Ground carrier terminal block	green-yellow	2020-1307	50			
	End and intermediate plate; 1 mm thick	orange	2020-1392	25		1 x 31,6 x 57,8 mm/ 0.04 x 1.24 x 2.28 inch	
	End and intermediate plate; 1 mm thick	gray	2020-1391	25			
<b>2-conductor/2-pin carrier terminal block</b>							
	Carrier terminal block	gray	2020-1401	50		3,5 x 32,5 x 85,2 mm/ 0.14 x 1.3 x 3.35 inch	500 V/6 kV/3 ①; I <sub>N</sub> 13,5 A; 300 V, 10 A ②; 300 V, 10 A ③
	Carrier terminal block	blue	2020-1404	50			
	Ground carrier terminal block	green-yellow	2020-1407	50			
	End and intermediate plate; 1 mm thick	orange	2020-1492	25		1 x 31,6 x 84,8 mm/ 0.04 x 1.24 x 3.34 inch	
	End and intermediate plate; 1 mm thick	gray	2020-1491	25			
<b>1-conductor/1-pin double-deck carrier terminal block</b>							
	Through/through terminal block; with marker carrier	gray	2020-2231	50	L/L	3,5 x 61,4 x 80,1 mm/ 0.14 x 2.41 x 3.15 inch	500 V/6 kV/3 ①; I <sub>N</sub> 13,5 A; 300 V, 10 A ②; 300 V, 10 A ③
		gray	2020-2232	50	N/L		
		gray	2020-2233	50	L/N		
		blue	2020-2234	50	N/N		
	Ground conductor/through terminal block; with marker carrier	gray	2020-2247	50	GND/N	3,5 x 51,3 x 80,1 mm/ 0.14 x 2.02 x 3.15 inch	500 V/6 kV/3 ①; I <sub>N</sub> 13,5 A; 300 V, 10 A ②; 300 V, 10 A ③
		gray	2020-2257	50	GND/L		
		gray	2020-2201	50	L/L		
		gray	2020-2202	50	N/L		
	Through/through terminal block; without marker carrier	gray	2020-2203	50	L/N	3,5 x 51,3 x 80,1 mm/ 0.14 x 2.02 x 3.15 inch	500 V/6 kV/3 ①; I <sub>N</sub> 13,5 A; 300 V, 10 A ②; 300 V, 10 A ③
		blue	2020-2204	50	N/N		
		gray	2020-2217	50	GND/N		
		gray	2020-2227	50	GND/L		
<b>2-conductor/2-pin double-deck carrier terminal block</b>							
	2-conductor/2-pin through terminal block; with marker carrier; internally commoned; violet conductor entry	gray	2020-2238	50	L	3,5 x 61,4 x 80,1 mm/ 0.14 x 2.41 x 3.15 inch	500 V/6 kV/3 ①; I <sub>N</sub> 13,5 A; 300 V, 10 A ②; 300 V, 10 A ③
		blue	2020-2239	50	N		
	2-conductor/2-pin ground terminal block; with marker carrier; internally commoned	green-yellow	2020-2237	50	GND	3,5 x 51,3 x 80,1 mm/ 0.14 x 2.02 x 3.15 inch	500 V/6 kV/3 ①; I <sub>N</sub> 13,5 A; 300 V, 10 A ②; 300 V, 10 A ③
		gray	2020-2208	50	L		
	2-conductor/2-pin through terminal block; without marker carrier; internally commoned; violet conductor entry	gray	2020-2209	50	N	3,5 x 51,3 x 80,1 mm/ 0.14 x 2.02 x 3.15 inch	500 V/6 kV/3 ①; I <sub>N</sub> 13,5 A; 300 V, 10 A ②; 300 V, 10 A ③
		blue	2020-2209	50	N		
	2-conductor/2-pin ground terminal block; without marker carrier; internally commoned	green-yellow	2020-2207	50	GND	3,5 x 51,3 x 80,1 mm/ 0.14 x 2.02 x 3.15 inch	500 V/6 kV/3 ①; I <sub>N</sub> 13,5 A; 300 V, 10 A ②; 300 V, 10 A ③
		gray	2020-2208	50	L		
	End and intermediate plate; 1 mm thick	orange	2020-2292	25		1 x 51,1 x 79,5 mm/ 0.04 x 2.01 x 3.13 inch	
	End and intermediate plate; 1 mm thick	gray	2020-2291	25			
These end plates also fit the 1-conductor/1-pin double-deck carrier terminal blocks!							
<b>Accessories</b>							
	Carrier with 6 coding pins; for coding female plugs	orange	2020-100	25			

Conductor range: 0.14 ... 1.5 mm<sup>2</sup> "s+f-st"; Push-in termination: 0.5 ... 1.5 mm<sup>2</sup> "s" and 0.5 ... 0.75 mm<sup>2</sup> "insulated ferrules; 12 mm"; 24 ... 16 AWG; Strip length: 9 ... 11 mm / 0.35 ... 0.43 inch

① 500 V = rated voltage  
6 kV = rated impulse voltage  
3 = pollution degree



Accessories: see pages 36 ... 38.

Marking: WMB/WMB Inline/Marking strips

Suitable operating tool: see page 39

## WAGO 1- and 2-Conductor Female Plug X-COM®S-SYSTEM-MINI – 2020 Series

1 (1,5) mm<sup>2</sup>

Image	Description	Color	Item No.	PU	Dimensions (W x H x D)	Electrical Data
<b>1-conductor female plug</b>						
	1-conductor female plug; fits into carrier terminal blocks; codable					
	2-pole	○ gray	2020-102	100	(3.5 x pole no.) x 40.5 x 22.4 mm / (0.14 x pole no.) x 1.59 x 0.88 inch	500 V/6 kV/3 ①; I <sub>N</sub> 13,5 A; 300 V, 10 A ②; 300 V, 10 A ③
	...		...			
15-pole	○ gray	2020-115	10			
	1-conductor end module; codable	○ gray	2020-181	250		500 V/6 kV/3 ①; I <sub>N</sub> 13,5 A; 300 V, 10 A ②; 300 V, 10 A ③
		● blue	2020-184	250		
		● green-yellow	2020-187	250		
	1-conductor base module; with end plate; codable	○ gray	2020-161	250		500 V/6 kV/3 ①; I <sub>N</sub> 13,5 A; 300 V, 10 A ②; 300 V, 10 A ③
		● blue	2020-164	250		
		● green-yellow	2020-167	250		
	1-conductor female plug; with ground base module (green-yellow); fits into carrier terminal blocks; codable				(3.5 x pole no.) x 40.5 x 22.4 mm / (0.14 x pole no.) x 1.59 x 0.88 inch	500 V/6 kV/3 ①; I <sub>N</sub> 13,5 A; 300 V, 10 A ②; 300 V, 10 A ③
	3-pole	○ gray	2020-103/000-036	50		
	...		...			
	1-conductor female plug; with ground end module (green-yellow); fits into carrier terminal blocks; codable				(3.5 x pole no.) x 40.5 x 22.4 mm / (0.14 x pole no.) x 1.59 x 0.88 inch	500 V/6 kV/3 ①; I <sub>N</sub> 13,5 A; 300 V, 10 A ②; 300 V, 10 A ③
	3-pole	○ gray	2020-103/000-037	50		
	...		...			
	1-conductor female plug; with ground end module (green-yellow); fits into carrier terminal blocks; codable				(3.5 x pole no.) x 40.5 x 22.4 mm / (0.14 x pole no.) x 1.59 x 0.88 inch	500 V/6 kV/3 ①; I <sub>N</sub> 13,5 A; 300 V, 10 A ②; 300 V, 10 A ③
	3-pole	○ gray	2020-103/000-037	50		
	...		...			
	1-conductor female plug; with ground end module (green-yellow); fits into carrier terminal blocks; codable				(3.5 x pole no.) x 40.5 x 22.4 mm / (0.14 x pole no.) x 1.59 x 0.88 inch	500 V/6 kV/3 ①; I <sub>N</sub> 13,5 A; 300 V, 10 A ②; 300 V, 10 A ③
	3-pole	○ gray	2020-103/000-037	50		
	...		...			
<b>2-conductor female plug</b>						
	2-conductor female plug; fits into carrier terminal blocks; codable				(3.5 x pole no.) x 40.5 x 25 mm / (0.14 x pole no.) x 1.59 x 0.98 inch	500 V/6 kV/3 ①; I <sub>N</sub> 13,5 A; 300 V, 10 A ②; 300 V, 10 A ③
	2-pole	○ gray	2020-202	100		
	...		...			
	2-conductor end module; codable	○ gray	2020-215	10		500 V/6 kV/3 ①; I <sub>N</sub> 13,5 A; 300 V, 10 A ②; 300 V, 10 A ③
		● blue	2020-281	250		
		● green-yellow	2020-284	250		
	2-conductor base module; with end plate; codable	○ gray	2020-261	250		500 V/6 kV/3 ①; I <sub>N</sub> 13,5 A; 300 V, 10 A ②; 300 V, 10 A ③
		● blue	2020-264	250		
		● green-yellow	2020-267	250		
	2-conductor female plug; with ground base module (green-yellow); fits into carrier terminal blocks; codable				(3.5 x pole no.) x 40.5 x 25 mm / (0.14 x pole no.) x 1.59 x 0.98 inch	500 V/6 kV/3 ①; I <sub>N</sub> 13,5 A; 300 V, 10 A ②; 300 V, 10 A ③
	3-pole	○ gray	2020-203/000-036	50		
	...		...			
	2-conductor female plug; with ground end module (green-yellow); fits into carrier terminal blocks; codable				(3.5 x pole no.) x 40.5 x 25 mm / (0.14 x pole no.) x 1.59 x 0.98 inch	500 V/6 kV/3 ①; I <sub>N</sub> 13,5 A; 300 V, 10 A ②; 300 V, 10 A ③
	3-pole	○ gray	2020-203/000-037	50		
	...		...			
	2-conductor female plug; with ground end module (green-yellow); fits into carrier terminal blocks; codable				(3.5 x pole no.) x 40.5 x 25 mm / (0.14 x pole no.) x 1.59 x 0.98 inch	500 V/6 kV/3 ①; I <sub>N</sub> 13,5 A; 300 V, 10 A ②; 300 V, 10 A ③
	3-pole	○ gray	2020-203/000-037	50		
	...		...			
<b>Female plug accessories</b>						
	Locking lever; 4,8 mm wide	● orange	2022-142	25		
	Locking lever; 4,8 mm wide	○ gray	2022-141	25		
	Locking lever; 9,6 mm wide	● orange	2022-152	25		
	Locking lever; 9,6 mm wide	○ gray	2022-151	25		
	Strain relief plate; 6 mm wide	○ gray	734-327	25		
	Strain relief plate; 12,5 mm wide	○ gray	734-328	25		
	Strain relief plate; 25 mm wide	○ gray	734-329	25		
	Strain relief plate; 35 mm wide	○ gray	734-326	25		

Conductor range: 0.14 ... 1.5 mm<sup>2</sup> "s-f-st"; Push-in termination: 0.5 ... 1.5 mm<sup>2</sup> "s" and 0.5 ... 0.75 mm<sup>2</sup> "insulated ferrules; 12 mm"; 24 ... 16 AWG; Strip length: 9 ... 11 mm / 0.35 ... 0.43 inch





① 500 V = rated voltage  
6 kV = rated impulse voltage  
3 = pollution degree

Accessories: see pages 36 ... 38.

Marking: WMB/WMB Inline/Marking strips

Suitable operating tool: see page 39

## WAGO Female Plugs for Self-Assembly; X-COM®S-SYSTEM-MINI/X-COM®S-SYSTEM – 2020/2022 Series 1 / 2,5 mm<sup>2</sup>

Image	Description	Color	Item No.	PU	Dimensions (W x H x D)	Electrical Data
<b>X-COM®S-SYSTEM-MINI; 1-conductor female plug for self-assembly</b>						
	1-conductor end module; codable	gray	2020-181	250	3,5 x 40,5 x 22,4 mm/ 0.14 x 1.6 x 0.9 inch	500 V/6 kV/3 ①; I <sub>N</sub> 13,5 A; 300 V, 10 A ②; 300 V, 10 A ③
		blue	2020-184	250		
		green-yellow	2020-187	250		
	1-conductor base module; with integrated end plate; codable	gray	2020-161	250	4,2 x 40,5 x 22,4 mm/ 0.17 x 1.6 x 0.9 inch	
		blue	2020-164	250		
		green-yellow	2020-167	250		
<b>X-COM®S-SYSTEM-MINI; 2-conductor female plug for self-assembly</b>						
	2-conductor end module; codable	gray	2020-281	250	3,5 x 40,5 x 25 mm/ 0.14 x 1.6 x 1 inch	500 V/6 kV/3 ①; I <sub>N</sub> 13,5 A; 300 V, 10 A ②; 300 V, 10 A ③
		blue	2020-284	250		
		green-yellow	2020-287	250		
	2-conductor base module; with integrated end plate; codable	gray	2020-261	250	4,2 x 40,5 x 25 mm/ 0.17 x 1.6 x 1 inch	
		blue	2020-264	250		
		green-yellow	2020-267	250		
<b>X-COM®S-SYSTEM; 1-conductor female plug for self-assembly</b>						
	1-conductor end module; codable	gray	2022-181	250	5,2 x 40,5 x 22,4 mm/ 0.21 x 1.6 x 0.9 inch	690 V/6 kV/3 ②; I <sub>N</sub> 24 A; 600 V, 20 A ③; 600 V, 20 A ④
		blue	2022-184	250		
		orange	2022-182	250		
	green-yellow	2022-187	250			
	1-conductor center module; codable	gray	2022-171	250	5,2 x 40,5 x 22,4 mm/ 0.21 x 1.6 x 0.9 inch	
		blue	2022-174	250		
orange		2022-172	250			
1-conductor base module; with integrated end plate; codable	gray	2022-161	250	5,2 x 40,5 x 22,4 mm/ 0.21 x 1.6 x 0.9 inch		
	blue	2022-164	250			
	orange	2022-162	250			
		green-yellow	2022-167	250		

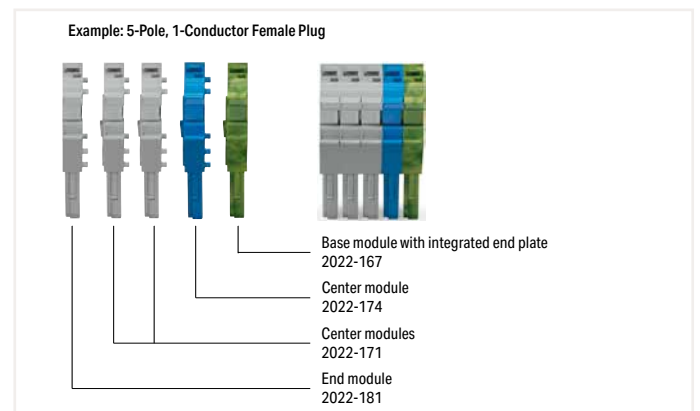
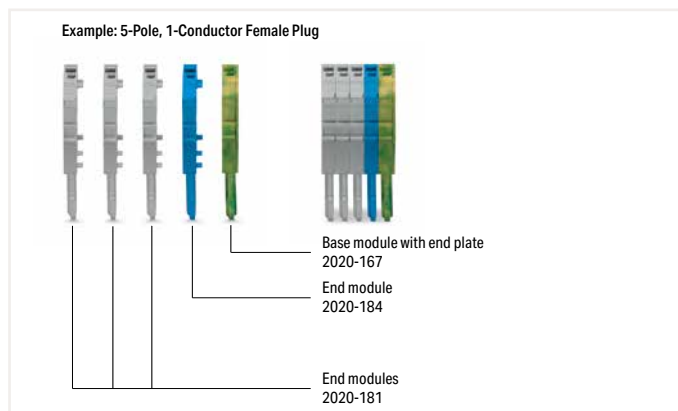

### Customizing Modular Female Plugs

WAGO's modular X-COM®S-SYSTEM female plugs can be customized for applications requiring varying numbers of poles (e.g., designing prototypes).

### Modules and Pole Numbers

A customized X-COM®S-SYSTEM-MINI female plug consists of:

- One base module with end plate
- Up to 14 end modules

### Intended Use

According to EN 61984, pluggable connectors without a current interrupting capacity must not be mated or unmated when live or under load.

### Assembly

The appropriate mounting tool shall be used in order to guarantee that the individual modules are properly attached to each other without damaging the locking latches.

### X-COM®S-SYSTEM-MINI; 2020 Series

Conductor range: 0.14 ... 1.5 mm<sup>2</sup> "s+f-st"; Push-in termination: 0.5 ... 1.5 mm<sup>2</sup> "s" and 0.5 ... 0.75 mm<sup>2</sup> "insulated ferrules; 10 mm"; 24 ... 16 AWG; Strip length: 9 ... 11 mm / 0.35 ... 0.43 inch

① 500 V = rated voltage  
6 kV = rated impulse voltage  
3 = pollution degree

Accessories: see pages 36 ... 38.

Marking: WMB/WMB Inline/Marking strips

Suitable operating tool: see page 39

### X-COM®S-SYSTEM; 2022 Series

Conductor range: 0.25 ... 4 mm<sup>2</sup> "s+f-st"; Push-in termination: 1 ... 4 mm<sup>2</sup> "s" and 1 ... 2.5 mm<sup>2</sup> "insulated ferrules; 12 mm"; 22 ... 12 AWG; Strip length: 10 ... 12 mm / 0.39 ... 0.47 inch

② 690 V = rated voltage  
6 kV = rated impulse voltage  
3 = pollution degree















Accessories: see pages 36 ... 38.

Marking: WMB/WMB Inline/Marking strips

Suitable operating tool: see page 39











# WAGO Carrier Terminal Block and Double-Deck Carrier Terminal Block X-COM®S-SYSTEM – 2022 Series 2.5 (4) mm<sup>2</sup>

1

Image	Description	Color	Item No.	PU	Potential Marking	Dimensions (W x H x D)	Electrical Data
<b>1-conductor/1-pin carrier terminal block</b>							
	Carrier terminal block	gray	2022-1201	100		5,2 x 32,5 x 48,5 mm/ 0.205 x 1.3 x 1.91 inch	690 V/6 kV/3 ①; I <sub>N</sub> 24 A (32 A); 600 V, 20 A ②; 600 V, 20 A ③
	Carrier terminal block	blue	2022-1204	100			
	Carrier terminal block	orange	2022-1202	100			
	Ground carrier terminal block	green-yellow	2022-1207	100			
	End and intermediate plate; 1 mm thick	orange	2022-1292	25		1 x 31,6 x 48,5 mm/	
	End and intermediate plate; 1 mm thick	gray	2022-1291	25		0.04 x 1.24 x 1.91 inch	
<b>2-conductor/1-pin carrier terminal block</b>							
	Carrier terminal block	gray	2022-1301	100		5,2 x 32,5 x 59,2 mm/ 0.205 x 1.3 x 2.33 inch	690 V/6 kV/3 ①; I <sub>N</sub> 24 A (32 A); 600 V, 20 A ②; 600 V, 20 A ③
	Carrier terminal block	blue	2022-1304	100			
	Carrier terminal block	orange	2022-1302	100			
	Ground carrier terminal block	green-yellow	2022-1307	100			
	End and intermediate plate; 1 mm thick	orange	2022-1392	25		1 x 31,6 x 58,9 mm/	
	End and intermediate plate; 1 mm thick	gray	2022-1391	25		0.04 x 1.24 x 2.32 inch	
<b>2-conductor/2-pin carrier terminal block</b>							
	Carrier terminal block	gray	2022-1401	100		5,2 x 32,5 x 86,2 mm/ 0.205 x 1.3 x 3.39 inch	690 V/6 kV/3 ①; I <sub>N</sub> 24 A (32 A); 600 V, 20 A ②; 600 V, 20 A ③
	Carrier terminal block	blue	2022-1404	100			
	Carrier terminal block	orange	2022-1402	100			
	Ground carrier terminal block	green-yellow	2022-1407	100			
	End and intermediate plate; 1 mm thick	orange	2022-1492	25		1 x 31,6 x 85,8 mm/	
	End and intermediate plate; 1 mm thick	gray	2022-1491	25		0.04 x 1.24 x 3.34 inch	
<b>2-pin carrier terminal block</b>							
	Carrier terminal block	gray	2022-1601	50		5,2 x 32,5 x 52 mm/ 0.205 x 1.3 x 2.05 inch	690 V/6 kV/3 ①; I <sub>N</sub> 24 A (32 A); 600 V, 20 A ②; 600 V, 20 A ③
	Carrier terminal block	blue	2022-1604	50			
	Carrier terminal block	orange	2022-1602	50			
	Ground carrier terminal block	green-yellow	2022-1607	50			
	End and intermediate plate; 1 mm thick	orange	2022-1692	25		1 x 32,5 x 52 mm/	
	End and intermediate plate; 1 mm thick	gray	2022-1691	25		0.04 x 1.3 x 2.05 inch	
<b>4-pin carrier terminal block</b>							
	Carrier terminal block	gray	2022-1801	50		5,2 x 32,5 x 106 mm/ 0.205 x 1.3 x 4.17 inch	690 V/6 kV/3 ①; I <sub>N</sub> 24 A (27 A); 600 V, 20 A ②; 600 V, 20 A ③
	Carrier terminal block	blue	2022-1804	50			
	Carrier terminal block	orange	2022-1802	50			
	Ground carrier terminal block	green-yellow	2022-1807	50			
	End and intermediate plate; 1 mm thick	orange	2022-1892	25		1 x 32,5 x 106 mm/	
	End and intermediate plate; 1 mm thick	gray	2022-1891	25		0.04 x 1.3 x 4.17 inch	
<b>1-conductor/1-pin double-deck carrier terminal block</b>							
	Through/through terminal block; with marker carrier	gray	2022-2231	50	L/L	5,2 x 61,4 x 80,1 mm/ 0.205 x 2.41 x 3.15 inch	690 V/6 kV/3 ①; I <sub>N</sub> 24 A (32 A); 600 V, 20 A ②; 600 V, 20 A ③
		gray	2022-2232	50	N/L		
		gray	2022-2233	50	L/N		
		blue	2022-2234	50	N/N		
		gray	2022-2247	50	GND/N		
	Ground conductor/through terminal block; with marker carrier	gray	2022-2257	50	GND/L	5,2 x 51,3 x 80,1 mm/ 0.205 x 2.02 x 3.15 inch	690 V/6 kV/3 ①; I <sub>N</sub> 24 A (32 A); 600 V, 20 A ②; 600 V, 20 A ③
		gray	2022-2201	50	L/L		
		gray	2022-2202	50	N/L		
		gray	2022-2203	50	L/N		
		blue	2022-2204	50	N/N		
	Through/through terminal block; without marker carrier	gray	2022-2217	50	GND/N	1 x 51,1 x 79,5 mm/ 0.04 x 2.01 x 3.13 inch	
		gray	2022-2217	50	GND/L		
		gray	2022-2217	50	GND/L		
		gray	2022-2217	50	GND/L		
		gray	2022-2217	50	GND/L		
	End and intermediate plate; 1 mm thick	orange	2022-2292	25			
	End and intermediate plate; 1 mm thick	gray	2022-2291	25			

# WAGO Double-Deck Carrier Terminal Block and 1-Conductor Female Plug X-COM®S-SYSTEM – 2022 Series

## 2.5 (4) mm<sup>2</sup>

Image	Description	Color	Item No.	PU	Potential Marking	Dimensions (W x H x D)	Electrical Data
<b>2-conductor/2-pin double-deck carrier terminal block</b>							
	2-conductor/2-pin through terminal block; with marker carrier; internally commoned; violet conductor entry	○ gray ● blue	2022-2238 2022-2239	50 50	L N	5,2 x 61,4 x 80,1 mm/ 0.205 x 2.41 x 3.15 inch	690 V/6 kV/3 ①; I <sub>N</sub> 24 A (32 A); 600 V, 20 A ②; 600 V, 20 A ③
	2-conductor/2-pin ground terminal block; with marker carrier; internally commoned	● green-yellow	2022-2237	50	GND		
	2-conductor/2-pin through terminal block; without marker carrier; internally commoned; violet conductor entry	○ gray ● blue	2022-2208 2022-2209	50 50	L N	5,2 x 51,3 x 80,1 mm/ 0.205 x 2.02 x 3.15 inch	690 V/6 kV/3 ①; I <sub>N</sub> 24 A (32 A); 600 V, 20 A ②; 600 V, 20 A ③
	2-conductor/2-pin ground terminal block; without marker carrier; internally commoned	● green-yellow	2022-2207	50	GND		
	End and intermediate plate; 1 mm thick	● orange	2022-2292	25		1 x 51,1 x 79,5 mm/	
	End and intermediate plate; 1 mm thick	○ gray	2022-2291	25		0.04 x 2.01 x 3.13 inch	
<b>1-conductor female plug</b>							
	1-conductor female plug; fits into carrier terminal blocks; codable						
	1-pole	○ gray	2022-101	200		(5.2 x pole no.) x 40.5 x 22.4 mm / (0.205 x pole no.) x 1.6 x 0.88 inch	690 V/6 kV/3 ①; I <sub>N</sub> 24 A (32 A); 600 V, 20 A ②; 600 V, 20 A ③
	2-pole	○ gray	2022-102	200			
	⋮		⋮				
15-pole	○ gray	2022-115	25				
	1-conductor female plug; with ground base module (green-yellow); fits into carrier terminal blocks; codable						
	3-pole	○ gray	2022-103/000-036	100		(5.2 x pole no.) x 40.5 x 22.4 mm / (0.205 x pole no.) x 1.6 x 0.88 inch	690 V/6 kV/3 ①; I <sub>N</sub> 24 A (32 A); 600 V, 20 A ②; 600 V, 20 A ③
	4-pole	○ gray	2022-104/000-036	100			
	⋮		⋮				
15-pole	○ gray	2022-115/000-036	25				
	1-conductor female plug; with ground end module (green-yellow); fits into carrier terminal blocks; codable						
	2-pole	○ gray	2022-102/000-037	100		(5.2 x pole no.) x 40.5 x 22.4 mm / (0.205 x pole no.) x 1.6 x 0.88 inch	690 V/6 kV/3 ①; I <sub>N</sub> 24 A (32 A); 600 V, 20 A ②; 600 V, 20 A ③
	3-pole	○ gray	2022-103/000-037	100			
	⋮		⋮				
15-pole	○ gray	2022-115/000-037	25				
<b>Carrier terminal block accessories</b>							
	Carrier with 6 coding pins; for coding female plugs	● orange	2022-100	25			
<b>Female plug accessories</b>							
	Locking lever; 4.8 mm wide	● orange	2022-142	25			
	Locking lever; 4.8 mm wide	○ gray	2022-141	25			
	Locking lever; 9.6 mm wide	● orange	2022-152	25			
	Locking lever; 9.6 mm wide	○ gray	2022-151	25			
	Strain relief plate; 6 mm wide	○ gray	734-327	25			
	Strain relief plate; 12.5 mm wide	○ gray	734-328	25			
	Strain relief plate; 25 mm wide	○ gray	734-329	25			
	Strain relief plate; 35 mm wide	○ gray	734-326	25			



X-COM®S-SYSTEM terminal block assembly

Conductor range: 0.25 ... 4 mm<sup>2</sup> "s+f-st"; Push-in termination: 1 ... 4 mm<sup>2</sup> "s" and 1 ... 2.5 mm<sup>2</sup> "insulated ferrules; 12 mm"; 22 ... 12 AWG;  
Strip length: 10 ... 12 mm / 0.39 ... 0.47 inch

① 690 V = rated voltage  
6 kV = rated impulse voltage  
3 = pollution degree

Accessories: see pages 36 ... 38.















Marking: WMB/WMB Inline/Marking strips

Suitable operating tool: see page 39

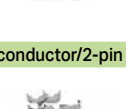
# WAGO Carrier Terminal Blocks and Double-Deck Carrier Terminal Blocks X-COM®S-SYSTEM; for Ex nA Applications – 2022 Series

## 2.5 (4) mm<sup>2</sup>

1

Image	Description	Color	Item No.	PU	Potential Marking	Dimensions (W x H x D)	Electrical Data
<b>1-conductor/1-pin carrier terminal block; suitable for Ex nA applications</b>							
	Carrier terminal block	gray	2022-1201/999-953	100		5,2 x 32,5 x 48,5 mm/ 0.205 x 1.3 x 1.91 inch	630 V <b>ⓘ</b> ; I <sub>N</sub> 20 A; 600 V, 20 A <b>⚡</b> ; 600 V, 20 A <b>Ⓢ</b>
	Carrier terminal block	blue	2022-1204/999-953	100			
	Ground carrier terminal block	green-yellow	2022-1207/999-953	100			
	End and intermediate plate; 1 mm thick	orange	2022-1292	25		1 x 31,6 x 48,5 mm/	
	End and intermediate plate; 1 mm thick	gray	2022-1291	25		0.04 x 1.24 x 1.91 inch	
<b>2-conductor/1-pin carrier terminal block</b>							
	Carrier terminal block	gray	2022-1301/999-953	50		5,2 x 32,5 x 59,2 mm/ 0.205 x 1.3 x 2.33 inch	630 V <b>ⓘ</b> ; I <sub>N</sub> 20 A; 600 V, 20 A <b>⚡</b> ; 600 V, 20 A <b>Ⓢ</b>
	Carrier terminal block	blue	2022-1304/999-953	50			
	Ground carrier terminal block	green-yellow	2022-1307/999-953	50			
	End and intermediate plate; 1 mm thick	orange	2022-1392	25		1 x 31,6 x 58,9 mm/	
	End and intermediate plate; 1 mm thick	gray	2022-1391	25		0.04 x 1.24 x 2.32 inch	
<b>2-conductor/2-pin carrier terminal block</b>							
	Carrier terminal block	gray	2022-1401/999-953	50		5,2 x 32,5 x 86,2 mm/ 0.205 x 1.3 x 3.39 inch	630 V <b>ⓘ</b> ; I <sub>N</sub> 20 A; 600 V, 20 A <b>⚡</b> ; 600 V, 20 A <b>Ⓢ</b>
	Carrier terminal block	blue	2022-1404/999-953	50			
	Ground carrier terminal block	green-yellow	2022-1407/999-953	50			
	End and intermediate plate; 1 mm thick	orange	2022-1492	25		1 x 31,6 x 85,8 mm/	
	End and intermediate plate; 1 mm thick	gray	2022-1491	25		0.04 x 1.24 x 3.34 inch	
<b>1-conductor/1-pin double-deck carrier terminal block</b>							
	Through/through terminal block; with marker carrier	gray	2022-2231/999-953	50	L/L	5,2 x 61,4 x 80,1 mm/ 0.205 x 2.41 x 3.15 inch	630 V <b>ⓘ</b> ; I <sub>N</sub> 20 A; 600 V, 20 A <b>⚡</b> ; 600 V, 20 A <b>Ⓢ</b>
		gray	2022-2232/999-953	50	N/L		
		gray	2022-2233/999-953	50	L/N		
		blue	2022-2234/999-953	50	N/N		
	Ground conductor/through terminal block; with marker carrier	gray	2022-2247/999-953	50	GND/N		
		gray	2022-2257/999-953	50	GND/L		
		gray	2022-2201/999-953	50	L/L		
		gray	2022-2202/999-953	50	N/L		
	Through/through terminal block; without marker carrier	gray	2022-2203/999-953	50	L/N	3,5 x 51,3 x 80,1 mm/ 0.14 x 2.02 x 3.15 inch	630 V <b>ⓘ</b> ; I <sub>N</sub> 20 A; 600 V, 20 A <b>⚡</b> ; 600 V, 20 A <b>Ⓢ</b>
		blue	2022-2204/999-953	50	N/N		
		gray	2022-2217/999-953	50	GND/N		
		gray	2022-2217/999-953	50	GND/L		
<b>2-conductor/2-pin double-deck carrier terminal block</b>							
	2-conductor/2-pin through terminal block; with marker carrier; internally commoned; violet conductor entry	gray	2022-2238/999-953	50	L	5,2 x 61,4 x 80,1 mm/ 0.205 x 2.41 x 3.15 inch	630 V <b>ⓘ</b> ; I <sub>N</sub> 20 A; 600 V, 20 A <b>⚡</b> ; 600 V, 20 A <b>Ⓢ</b>
		blue	2022-2239/999-953	50	N		
	2-conductor/2-pin ground terminal block; with marker carrier; internally commoned	green-yellow	2022-2237/999-953	50	GND		
	2-conductor/2-pin through terminal block; without marker carrier; internally commoned; violet conductor entry	gray	2022-2208/999-953	50	L	3,5 x 51,3 x 80,1 mm/ 0.14 x 2.02 x 3.15 inch	630 V <b>ⓘ</b> ; I <sub>N</sub> 20 A; 600 V, 20 A <b>⚡</b> ; 600 V, 20 A <b>Ⓢ</b>
		blue	2022-2209/999-953	50	N		
	2-conductor/2-pin ground terminal block; without marker carrier; internally commoned	green-yellow	2022-2207/999-953	50	GND		
	End and intermediate plate; 1 mm thick	orange	2022-2292	25		1 x 51,1 x 79,5 mm/	
	End and intermediate plate; 1 mm thick	gray	2022-2291	25		0.04 x 2.01 x 3.13 inch	
	These end plates also fit the 1-conductor/1-pin double-deck carrier terminal blocks!						

Conductor range: 0.25 ... 4 mm<sup>2</sup> "s+f-st"; Push-in termination: 1 ... 4 mm<sup>2</sup> "s" and 1 ... 2.5 mm<sup>2</sup> "insulated ferrules; 12 mm"; 22 ... 12 AWG; Strip length: 10 ... 12 mm / 0.39 ... 0.47 inch





**ⓘ** 630 V = rated voltage for use in Zone 2 hazardous areas, "nA" type of protection

Accessories: see pages 36 ... 38.  
Marking: WMB/WMB Inline/Marking strips  
Suitable operating tool: see page 39



# WAGO 1-Conductor Female Plug X-COM®S-SYSTEM; for Ex nA Applications – 2022 Series

## 2.5 (4) mm<sup>2</sup>

Image	Description	Color	Item No.	PU	Dimensions (W x H x D)	Electrical Data
<b>1-Conductor Female Plug; for Ex nA Applications</b>						
	1-conductor female plug; with locking lever; fits into carrier terminal blocks; codable					
	2-pole	○ gray	2022-102/999-953	200	(5.2 x pole no.) x 40.5 x 26.8 mm / (0.205 x pole no.) x 1.6 x 1.06 inch	630 V <b>ⓘ</b> ; I <sub>N</sub> 20 A; 600 V, 20 A <b>Ⓜ</b> ; 600 V, 20 A <b>Ⓢ</b>
	3-pole	○ gray	2022-103/999-953	100		
	4-pole	○ gray	2022-104/999-953	100		
	5-pole	○ gray	2022-105/999-953	50		
	6-pole	○ gray	2022-106/999-953	50		
	7-pole	○ gray	2022-107/999-953	50		
	8-pole	○ gray	2022-108/999-953	50		
	1-conductor female plug; with shorter locking lever; with ground base module (green-yellow); fits into carrier terminal blocks; codable					
	3-pole	○ gray	2022-103/000-038/999-953	100	(5.2 x pole no.) x 40.5 x 26.8 mm / (0.205 x pole no.) x 1.6 x 1.06 inch	630 V <b>ⓘ</b> ; I <sub>N</sub> 20 A; 600 V, 20 A <b>Ⓜ</b> ; 600 V, 20 A <b>Ⓢ</b>
	4-pole	○ gray	2022-104/000-038/999-953	100		
	5-pole	○ gray	2022-105/000-038/999-953	50		
	6-pole	○ gray	2022-106/000-038/999-953	50		
6-pole	○ gray	2022-106/000-039/999-953	50			
	1-conductor female plug; with shorter locking lever; with ground end module (green-yellow); fits into carrier terminal blocks; codable					
	3-pole	○ gray	2022-103/000-039/999-953	100	(5.2 x pole no.) x 40.5 x 26.8 mm / (0.205 x pole no.) x 1.6 x 1.06 inch	630 V <b>ⓘ</b> ; I <sub>N</sub> 20 A; 600 V, 20 A <b>Ⓜ</b> ; 600 V, 20 A <b>Ⓢ</b>
	4-pole	○ gray	2022-104/000-039/999-953	100		
	5-pole	○ gray	2022-105/000-039/999-953	50		
	6-pole	○ gray	2022-106/000-039/999-953	50		
6-pole	○ gray	2022-106/000-039/999-953	50			
<b>Female plug accessories</b>						
	Strain relief plate; 6 mm wide	○ gray	734-327	25		
	Strain relief plate; 12.5 mm wide	○ gray	734-328	25		
	Strain relief plate; 25 mm wide	○ gray	734-329	25		
	Strain relief plate; 35 mm wide	○ gray	734-326	25		



630 V = rated voltage for use in Zone 2 hazardous areas, "nA" type of protection

"n" refers to an ignition protection class in Zone 2: This zone covers areas in which a dangerous, explosive atmosphere consisting of gases, vapors or dust is unlikely to exist and will only persist for a short period if it does.

"A" means: non-sparking (function modules without relays/ switches)

Ex marking:  
"Ex" sign and extended item number ".../999-953" are printed on the side of both carrier terminal blocks and female plugs with Ex approval.  
Shorter locking lever (factory-mounted) makes accidental disconnection more difficult.

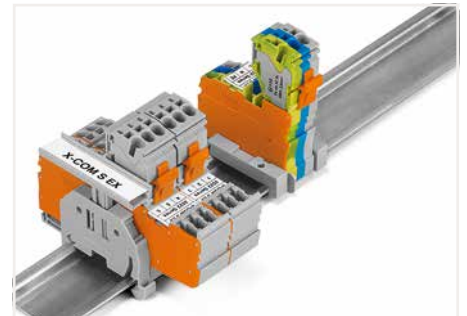

Group marking with height-adjustable group marker carrier (2009-163)

# WAGO Rail-Mount Terminal Blocks "Classic" Operation

1



By snapping a ground conductor terminal block onto the DIN-rail, a direct electrical connection is automatically made to the rail.

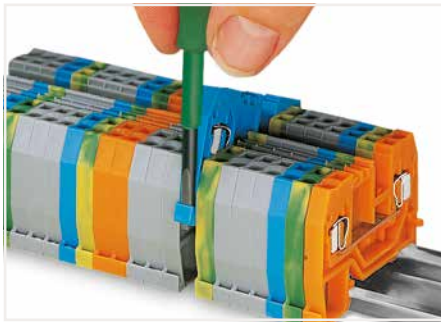

Removing a terminal block from the assembly.



**CAGE CLAMP® connection**  
Inserting a conductor.  
With ferruled conductors, it is necessary to use a terminal block one size larger than the conductor's nominal cross-section.

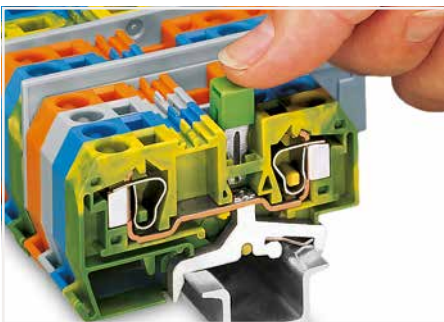

Commoning ground conductor terminal blocks with through terminal blocks is possible in one direction only (via rear side of terminal block) using adjacent jumpers. WAGO recommends using yellow-green adjacent jumpers in addition to the required marking of these blocks.

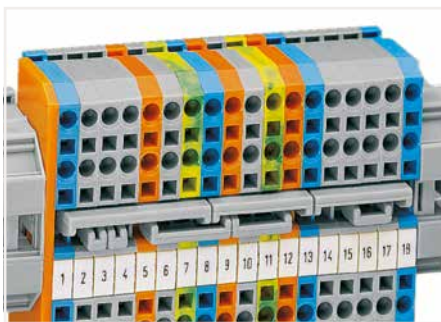

Staggered jumpers for sophisticated circuit requirements – push jumpers down until fully inserted.

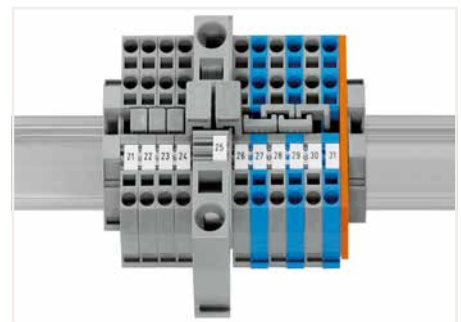

Commoning from 16 mm<sup>2</sup>/6 AWG (283 Series) to 4 mm<sup>2</sup>/12 AWG (281 Series) rail-mount terminal blocks via step-down jumpers.

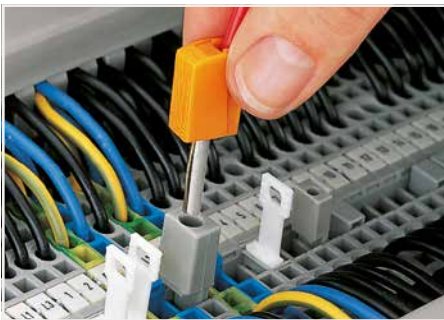

Testing with a test plug – Picture shows a test plug adapter (209-170).

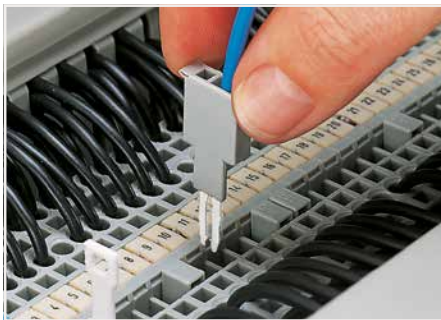

Testing with a test plug – (picture shows a test plug fitted with CAGE CLAMP®).



Finger guard seals an unused conductor entry.



Protective warning markers inserted into the operating slots

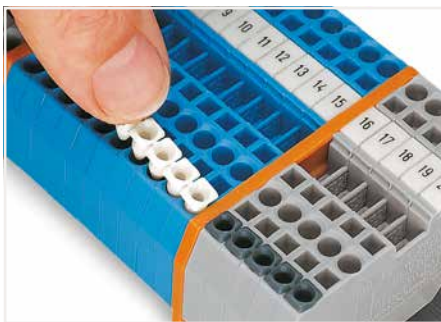









Inserting insulation stops.



Labeling via WMB Multi Marking System.

## WAGO Through/Ground/Shield Terminal Block – 279 Series

### 1,5 mm<sup>2</sup>

Image	Description	Color	Item No.	PU	Dimensions (W x H x D)	Electrical Data
<b>2-conductor through terminal block</b>						
	2-conductor through terminal block	○ gray	279-901	100	4 x 27 x 52 mm / 0.16 x 1.06 x 2.05 inch	800 V/8 kV/3 ①; I <sub>N</sub> 18 A; 600 V, 10 A ②; 600 V, 10 A ③
	2-conductor through terminal block	● blue	279-904 ②	100		
	2-conductor through terminal block	● orange	279-902	100		
	2-conductor through terminal block	● red	279-903	100		
	2-conductor through terminal block	● black	279-905	100		
	2-conductor through terminal block	● yellow	279-906	100		
	2-conductor through terminal block	○ light gray ③	279-992 ③	100		
	2-conductor ground terminal block	● green-yellow	279-907	100		
	2-conductor ground terminal block	● green-yellow ③	279-907/999-950 ③	100		
	End and intermediate plate; 2 mm thick	● orange	279-328	25	2 x 27 x 51,4 mm / 0.08 x 1.06 x 2.02 inch	
	End and intermediate plate; 2 mm thick	○ gray	279-325	25		
	End and intermediate plate; 2 mm thick	○ light gray	279-330	25		
<b>3-conductor through terminal block</b>						
	3-conductor through terminal block	○ gray	279-681	100	4 x 27 x 62,5 mm / 0.16 x 1.06 x 2.46 inch	800 V/8 kV/3 ①; I <sub>N</sub> 18 A; 600 V, 10 A ②; 600 V, 10 A ③
	3-conductor through terminal block	● blue	279-684 ②	100		
	3-conductor through terminal block	● orange	279-682	100		
	3-conductor through terminal block	● red	279-683	100		
	3-conductor through terminal block	● black	279-685	100		
	3-conductor through terminal block	● yellow	279-686	100		
	3-conductor through terminal block	○ light gray ③	279-993 ③	100		
	3-conductor ground terminal block	● green-yellow	279-687	100		
	3-conductor ground terminal block	● green-yellow ③	279-687/999-950 ③	100		
	End and intermediate plate; 2 mm thick	● orange	279-339	25	2 x 27 x 61,8 mm / 0.08 x 1.06 x 2.43 inch	
	End and intermediate plate; 2 mm thick	○ gray	279-308	25		
	End and intermediate plate; 2 mm thick	○ light gray	279-341	25		
<b>4-conductor through terminal block</b>						
	4-conductor through terminal block	○ gray	279-831	100	4 x 27 x 73 mm / 0.16 x 1.06 x 2.87 inch	800 V/8 kV/3 ①; I <sub>N</sub> 18 A; 600 V, 10 A ②; 600 V, 10 A ③
	4-conductor through terminal block	● blue	279-834 ②	100		
	4-conductor through terminal block	● orange	279-832	100		
	4-conductor through terminal block	● red	279-833	100		
	4-conductor through terminal block	● black	279-835	100		
	4-conductor through terminal block	● yellow	279-836	100		
	4-conductor through terminal block	○ light gray ③	279-994 ③	100		
	4-conductor ground terminal block	● green-yellow	279-837	100		
	4-conductor ground terminal block	● green-yellow ③	279-837/999-950 ③	100		
	End and intermediate plate; 2 mm thick	● orange	279-346	25	2 x 27 x 72,2 mm / 0.08 x 1.06 x 2.84 inch	
	End and intermediate plate; 2 mm thick	○ gray	279-344	25		
	End and intermediate plate; 2 mm thick	○ light gray	279-348	25		
<b>Double potential terminal block</b>						
	Double-potential terminal block; with double, center marking level	○ gray	279-826	100	4 x 27 x 73 mm / 0.16 x 1.06 x 2.87 inch	800 V/8 kV/3 ①; I <sub>N</sub> 18 A; 600 V, 10 A ②; 600 V, 10 A ③
		○ light gray ③	279-995 ③	100		
	End and intermediate plate; 2 mm thick	● orange	279-346	25	2 x 27 x 72,2 mm / 0.08 x 1.06 x 2.84 inch	
	End and intermediate plate; 2 mm thick	○ gray	279-344	25		
	End and intermediate plate; 2 mm thick	○ light gray	279-348	25		

Conductor range: 0.08 ... 1.5 mm<sup>2</sup>; 28 ... 16 AWG;  
Strip length: 8 ... 9 mm / 0.31 ... 0.35 inch

Accessories: see page 96

① 800 V = rated voltage  
8 kV = rated impulse voltage  
3 = pollution degree

Marking: WMB/WMB Inline/Marking strips

② Suitable for Ex i applications

③ Suitable for Ex e II applications; 550 V; 15 A

Suitable operating tool: see page 279

# WAGO Through/Ground/Shield Terminal Block – 280 Series

## 2,5 mm<sup>2</sup>

1

Image	Description	Color	Item No.	PU	Dimensions (W x H x D)	Electrical Data			
<b>2-conductor through terminal block</b>									
	2-conductor through terminal block	gray	280-901	100	5 x 28 x 53 mm / 0.2 x 1.1 x 2.09 inch	800 V/8 kV/3 ①; I <sub>n</sub> 24 A; 600 V, 20 A ②; 600 V, 25 A ③			
	2-conductor through terminal block	blue	280-904 ②	100					
	2-conductor through terminal block	orange	280-902	100					
	2-conductor through terminal block	red	280-903	100					
	2-conductor through terminal block	black	280-905	100					
	2-conductor through terminal block	yellow	280-906	100					
	2-conductor through terminal block	light gray ③	280-992 ③	100					
	2-conductor ground terminal block	green-yellow	280-907	100					
	2-conductor ground terminal block	green-yellow ③	280-907/999-950 ③	100					
		End and intermediate plate; 2 mm thick	orange	280-309			25	2,5 x 28 x 52,5 mm / 0.1 x 1.1 x 2.07 inch	
End and intermediate plate; 2 mm thick		gray	280-308	25					
End and intermediate plate; 2 mm thick		light gray	280-356	25					
<b>3-conductor through terminal block</b>									
	3-conductor through terminal block	gray	280-681	100	5 x 28 x 64 mm / 0.2 x 1.1 x 2.52 inch	800 V/8 kV/3 ①; I <sub>n</sub> 24 A; 600 V, 20 A ②; 600 V, 15 A ③			
	3-conductor through terminal block	blue	280-684 ②	100					
	3-conductor through terminal block	orange	280-650	100					
	3-conductor through terminal block	red	280-653	100					
	3-conductor through terminal block	black	280-671	100					
	3-conductor through terminal block	yellow	280-672	100					
	3-conductor through terminal block	light gray ③	280-993 ③	100					
	3-conductor ground terminal block	green-yellow	280-687	100					
	3-conductor ground terminal block	green-yellow ③	280-687/999-950 ③	100					
		End and intermediate plate; 2 mm thick	orange	280-326			25	2,5 x 26,4 x 63,8 mm / 0.1 x 1.04 x 2.51 inch	
End and intermediate plate; 2 mm thick		gray	280-324	25					
End and intermediate plate; 2 mm thick		light gray	280-358	25					
	3-conductor through terminal block	gray	280-631	100	5 x 36,5 x 50,5 mm / 0.2 x 1.44 x 1.99 inch	800 V/8 kV/3 ①; I <sub>n</sub> 24 A; 600 V, 20 A ②;			
	3-conductor through terminal block	blue	280-651 ②	100					
	3-conductor through terminal block	orange	280-654	100					
	3-conductor through terminal block	light gray ③	280-998 ③	100					
	3-conductor shield terminal block	white	280-640	100					
	3-conductor ground terminal block	green-yellow	280-637	100					
	3-conductor ground terminal block	green-yellow ③	280-637/999-950 ③	100					
		End and intermediate plate; 2.5 mm thick	orange	280-313			25	2,5 x 36,5 x 50 mm / 0.1 x 1.44 x 1.97 inch	
		End and intermediate plate; 2.5 mm thick	gray	280-312			25		
		End and intermediate plate; 2.5 mm thick	light gray	280-354			25		
<b>4-conductor through terminal block</b>									
	4-conductor through terminal block	gray	280-833	100	5 x 28 x 75 mm / 0.2 x 1.1 x 2.95 inch	800 V/8 kV/3 ①; I <sub>n</sub> 20 A; 600 V, 20 A ②; 600 V, 25 A ③			
	4-conductor through terminal block	blue	280-834 ②	100					
	4-conductor through terminal block	orange	280-835	100					
	4-conductor through terminal block	red	280-830	100					
	4-conductor through terminal block	black	280-831	100					
	4-conductor through terminal block	yellow	280-832	100					
	4-conductor through terminal block	light gray ③	280-994 ③	100					
	4-conductor ground terminal block	green-yellow	280-837	100					
	4-conductor ground terminal block	green-yellow ③	280-837/999-950 ③	100					
		End and intermediate plate; 2 mm thick	orange	280-315			25	2,5 x 28 x 75 mm / 0.1 x 1.1 x 2.96 inch	
End and intermediate plate; 2 mm thick		gray	280-314	25					
End and intermediate plate; 2 mm thick		light gray	280-352	25					
	4-conductor through terminal block	gray	280-646	100	2,5 x 36,5 x 50 mm / 0.1 x 1.44 x 1.97 inch				
	4-conductor through terminal block	blue	280-656 ②	100					
	4-conductor through terminal block	orange	280-946	100					
	4-conductor through terminal block	light gray ③	280-996 ③	100					
	End and intermediate plate; 2.5 mm thick	orange	280-313	25					
	End and intermediate plate; 2.5 mm thick	gray	280-312	25					
	End and intermediate plate; 2.5 mm thick	light gray	280-354	25					

Conductor range: 0.08 ... 2.5 mm<sup>2</sup>; 28 ... 12 AWG;  
Strip length: 8 ... 9 mm / 0.31 ... 0.35 inch  
Accessories: see page 96  
Marking: WMB/WMB Inline/Marking strips

① 800 V = rated voltage  
8 kV = rated impulse voltage  
3 = pollution degree









Suitable operating tool: see page 279

② Suitable for Ex i applications

③ Suitable for Ex e II; 550 V applications;  
23 A (2-conductor terminal blocks) / 22 A (3-conductor terminal blocks) / 20 A (4-conductor terminal blocks)

# WAGO Through/Ground/Shield Terminal Block – 281 Series

## 4 mm<sup>2</sup>

Image	Description	Color	Item No.	PU	Dimensions (W x H x D)	Electrical Data
<b>2-conductor through terminal block</b>						
	2-conductor through terminal block	○ gray	281-901	50	6 x 29 x 59,2 mm / 0.24 x 1.14 x 2.33 inch	800 V/8 kV/3 ①; I <sub>N</sub> 32 A; 600 V, 20 A ②; 600 V, 25 A ③
	2-conductor through terminal block	● blue	281-904 ②	50		
	2-conductor through terminal block	● orange	281-902	50		
	2-conductor through terminal block	● red	281-903	50		
	2-conductor through terminal block	● black	281-905	50		
	2-conductor through terminal block	● yellow	281-906	50		
	2-conductor through terminal block	○ light gray ③	281-992 ③	50		
	2-conductor ground terminal block	● green-yellow	281-907	50		
	2-conductor ground terminal block	● green-yellow ③	281-907/999-950 ③	50		
		End and intermediate plate; 2 mm thick	● orange	281-329		
End and intermediate plate; 2 mm thick		○ gray	281-328	25		
End and intermediate plate; 2 mm thick		○ light gray	281-349	25		
<b>3-conductor through terminal block</b>						
	3-conductor through terminal block	○ gray	281-681	50	6 x 29 x 73,5 mm / 0.24 x 1.14 x 2.89 inch	800 V/8 kV/3 ①; I <sub>N</sub> 32 A; 600 V, 20 A ②; 600 V, 25 A ③
	3-conductor through terminal block	● blue	281-684 ②	50		
	3-conductor through terminal block	● orange	281-678	50		
	3-conductor through terminal block	● red	281-679	50		
	3-conductor through terminal block	● black	281-685	50		
	3-conductor through terminal block	● yellow	281-686	50		
	3-conductor through terminal block	○ light gray ③	281-993 ③	50		
	3-conductor ground terminal block	● green-yellow	281-687	50		
	3-conductor ground terminal block	● green-yellow ③	281-687/999-950 ③	50		
		End and intermediate plate; 2 mm thick	● orange	281-326		
End and intermediate plate; 2 mm thick		○ gray	281-324	25		
End and intermediate plate; 2 mm thick		○ light gray	281-355	25		
	3-conductor through terminal block	○ gray	281-631	100	6 x 37 x 61,5 mm / 0.24 x 1.46 x 2.42 inch	800 V/8 kV/3 ①; I <sub>N</sub> 32 A; 600 V, 20 A ②; 600 V, 25 A ③
	3-conductor through terminal block	● blue	281-651 ②	100		
	3-conductor through terminal block	○ light gray ③	281-998 ③	100		
	3-conductor ground terminal block	● green-yellow	281-637	100		
	3-conductor ground terminal block	● green-yellow ③	281-637/999-950 ③	100		
	3-conductor shield terminal block	○ white	281-658	50		
	End and intermediate plate; 2 mm thick	● orange	281-313	25	2,5 x 37 x 61 mm / 0.1 x 1.46 x 2.4 inch	
	End and intermediate plate; 2 mm thick	○ gray	281-312	25		
	End and intermediate plate; 2 mm thick	○ light gray	281-357	25		
<b>4-conductor through terminal block</b>						
	4-conductor through terminal block	○ gray	281-652	50	6 x 29 x 86 mm / 0.24 x 1.14 x 3.39 inch	800 V/8 kV/3 ①; I <sub>N</sub> 26 A; 600 V, 20 A ②; 600 V, 25 A ③
	4-conductor through terminal block	● blue	281-654 ②	50		
	4-conductor through terminal block	● orange	281-653	50		
	4-conductor through terminal block	● red	281-663	50		
	4-conductor through terminal block	● black	281-664	50		
	4-conductor through terminal block	● yellow	281-668	50		
	4-conductor through terminal block	○ light gray ③	281-994 ③	50		
	4-conductor ground terminal block	● green-yellow	281-657	50		
	4-conductor ground terminal block	● green-yellow ③	281-657/999-950 ③	50		
	4-conductor shield terminal block	○ white	281-658	50		
	End and intermediate plate; 2 mm thick	● orange	281-335	25	2,5 x 29 x 86,1 mm / 0.1 x 1.14 x 3.39 inch	
	End and intermediate plate; 2 mm thick	○ gray	281-334	25		
	End and intermediate plate; 2 mm thick	○ light gray	281-345	25		

Conductor range: 0.08 ... 4 mm<sup>2</sup>; 28 ... 12 AWG;  
Strip length: 9 ... 10 mm / 0.35 ... 0.39 inch

Accessories: see page 96

① 800 V = rated voltage  
8 kV = rated impulse voltage  
3 = pollution degree

Marking: WMB/WMB Inline/Marking strips

② Suitable for Ex i applications

③ Suitable for Ex e II applications; 550 V; 30 A

Suitable operating tool: see page 279

# WAGO Through/Ground Terminal Block – 282/284 Series

## 6 / 10 mm<sup>2</sup>

1

Image	Description	Color	Item No.	PU	Dimensions (W x H x D)	Electrical Data
<b>2-conductor through terminal block; 6 mm<sup>2</sup> ①</b>						
	2-conductor through terminal block	○ gray	282-901	50	8 x 32,5 x 74,5 mm / 0.32 x 1.28 x 2.93 inch	800 V/8 kV/3 ③; I <sub>n</sub> 41 A; 600 V, 30 A ④; 600 V, 40 A ⑤
	2-conductor through terminal block	● blue	282-904 ④	50		
	2-conductor through terminal block	● orange	282-902	50		
	2-conductor through terminal block	○ light gray ⑥	282-992 ⑤	50		
	2-conductor ground terminal block	● green-yellow	282-907	50		
	2-conductor ground terminal block	● green-yellow ⑥	282-907/999-950 ⑤	50		
	End and intermediate plate; 2 mm thick	● orange	282-328	25	2,5 x 32,5 x 74,1 mm / 0.1 x 1.28 x 2.92 inch	
	End and intermediate plate; 2 mm thick	○ gray	282-325	25		
	End and intermediate plate; 2 mm thick	○ light gray	282-330	25		
<b>3-conductor through terminal block; 6 mm<sup>2</sup> ①</b>						
	3-conductor through terminal block	○ gray	282-681	25	8 x 32,5 x 93 mm / 0.32 x 1.28 x 3.66 inch	800 V/8 kV/3 ③; I <sub>n</sub> 41 A; 600 V, 30 A ④; 600 V, 40 A ⑤
	3-conductor through terminal block	● blue	282-684 ④	25		
	3-conductor through terminal block	● orange	282-682	25		
	3-conductor through terminal block	○ light gray ⑥	282-993 ⑤	50		
	3-conductor ground terminal block	● green-yellow	282-687	25		
	3-conductor ground terminal block	● green-yellow ⑥	282-687/999-950 ⑤	50		
	End and intermediate plate; 2 mm thick	● orange	282-339	25	2,5 x 32,5 x 92,8 mm / 0.1 x 1.28 x 3.65 inch	
	End and intermediate plate; 2 mm thick	○ gray	282-308	25		
	End and intermediate plate; 2 mm thick	○ light gray	282-341	25		
<b>2-conductor through terminal block; 10 mm<sup>2</sup> ②</b>						
	2-conductor through terminal block	○ gray	284-901	25	10 x 35 x 78 mm / 0.4 x 1.38 x 3.07 inch	800 V/8 kV/3 ③; I <sub>n</sub> 57 A; 600 V, 50 A ④; 600 V, 54 A ⑤
	2-conductor through terminal block	● blue	284-904	25		
	2-conductor through terminal block	● orange	284-902	25		
	2-conductor through terminal block	○ light gray ⑥	284-992 ⑥	25		
	2-conductor ground terminal block	● green-yellow	284-907	25		
	2-conductor ground terminal block	● green-yellow ⑥	284-907/999-950 ⑥	25		
	End and intermediate plate; 2 mm thick	● orange	284-328	25	2,5 x 35 x 77,5 mm / 0.1 x 1.34 x 3.05 inch	
	End and intermediate plate; 2 mm thick	○ gray	284-325	25		
	End and intermediate plate; 2 mm thick	○ light gray	284-330	25		
<b>3-conductor through terminal block; 10 mm<sup>2</sup> ②</b>						
	3-conductor through terminal block	○ gray	284-681	25	10 x 35 x 97,5 mm / 0.4 x 1.38 x 3.84 inch	800 V/8 kV/3 ③; I <sub>n</sub> 57 A; 600 V, 50 A ④; 600 V, 54 A ⑤
	3-conductor through terminal block	● blue	284-684	25		
	3-conductor through terminal block	● orange	284-682	25		
	3-conductor through terminal block	○ light gray ⑥	284-993 ⑥	25		
	3-conductor ground terminal block	● green-yellow	284-687	25		
	3-conductor ground terminal block	● green-yellow ⑥	284-687/999-950 ⑥	25		
	End and intermediate plate; 2 mm thick	● orange	284-339	25	2,5 x 35 x 97,4 mm / 0.1 x 1.34 x 3.84 inch	
	End and intermediate plate; 2 mm thick	○ gray	284-308	25		
	End and intermediate plate; 2 mm thick	○ light gray	284-341	25		

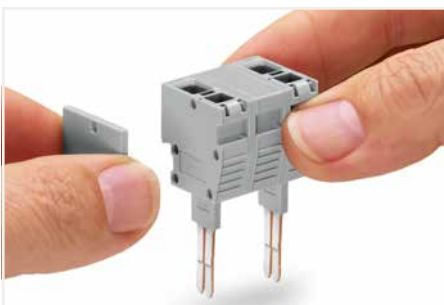

Snapping test plug and spacer modules (each with a spacer plate) together to assemble a multi-pole test plug module (max. 10 poles) for 10 mm terminal block width.

- ① Conductor range: 0.2 ... 6 mm<sup>2</sup>; 24 ... 10 AWG;  
Strip length: 12 ... 13 mm / 0.47 ... 0.51 inch
- ② Conductor range: 0.2 ... 10 mm<sup>2</sup>; 24 ... 8 AWG;  
Strip length: 12 ... 13 mm / 0.47 ... 0.51 inch

Accessories: see page 96



The test plug modules are directly plugged into the jumper contact slot of the current bar (picture shows 284 Series).

- ③ 800 V = rated voltage  
8 kV = rated impulse voltage  
3 = pollution degree

Marking: WMB/WMB Inline/Marking strips



Finger guard seals an unused conductor entry.

- ④ Suitable for Ex i applications
- ⑤ Suitable for Ex e II applications; 550 V; 39 A
- ⑥ Suitable for Ex e II applications; 550 V; 53 A

Suitable operating tool: see page 279

# WAGO Through/Ground Terminal Block – 283/285 Series

## 16 / 35 mm<sup>2</sup>

Image	Description	Color	Item No.	PU	Dimensions (W x H x D)	Electrical Data
<b>2-conductor through terminal block; 16 mm<sup>2</sup> ①</b>						
	2-conductor through terminal block	○ gray	283-901	20	12 x 37,5 x 94,5 mm / 0.47 x 1.48 x 3.72 inch	800 V/8 kV/3 ③; I <sub>n</sub> 76 A; 600 V, 65 A ④; 600 V, 70 A ⑤
	2-conductor through terminal block	● blue	283-904	20		
	2-conductor through terminal block	● orange	283-902	20		
	2-conductor through terminal block	○ light gray ⑥	283-992 ④	20		
	2-conductor ground terminal block	● green-yellow	283-907	20		
	2-conductor ground terminal block	● green-yellow ⑥	283-907/999-950 ④	20		
	End and intermediate plate; 2 mm thick	● orange	283-328	25	2,5 x 37,5 x 94,4 mm / 0.1 x 1.48 x 3.72 inch	
	End and intermediate plate; 2 mm thick	○ gray	283-325	25		
	End and intermediate plate; 2 mm thick	○ light gray	283-330	25		
<b>3-conductor through terminal block; 16 mm<sup>2</sup> ①</b>						
	3-conductor through terminal block	○ gray	283-671	20	12 x 37,5 x 104,5 mm / 0.47 x 1.48 x 4.11 inch	800 V/8 kV/3 ③; I <sub>n</sub> 76 A; 600 V, 65 A ④; 600 V, 70 A ⑤
	3-conductor through terminal block	● blue	283-674	20		
	3-conductor through terminal block	● orange	283-672	20		
	3-conductor through terminal block	○ light gray ⑥	283-998 ④	20		
	3-conductor ground terminal block	● green-yellow	283-677	20		
	3-conductor ground terminal block	● green-yellow ⑥	283-677/999-950 ④	20		
	End and intermediate plate; 2 mm thick	● orange	283-352	25	2,5 x 37,5 x 104,3 mm / 0.1 x 1.48 x 4.12 inch	
	End and intermediate plate; 2 mm thick	○ gray	283-350	25		
	End and intermediate plate; 2 mm thick	○ light gray	283-354	25		
<b>2-conductor through terminal block; 35 mm<sup>2</sup> ②</b>						
	2-conductor through terminal block	○ gray	285-635	15	16 x 53 x 100 mm / 0.63 x 2.09 x 3.94 inch	1000 V/8 kV/3 ③; I <sub>n</sub> 125 A; 600 V, 115 A ④; 600 V, 120 A ⑤
	2-conductor through terminal block	● blue	285-634	15		
	2-conductor through terminal block	○ light gray ⑥	285-992 ⑤	15		
	2-conductor ground terminal block	● green-yellow	285-637	15		
	2-conductor ground terminal block	● green-yellow ⑥	285-637/999-950 ⑤	15		



Protective warning markers inserted into the operating slots

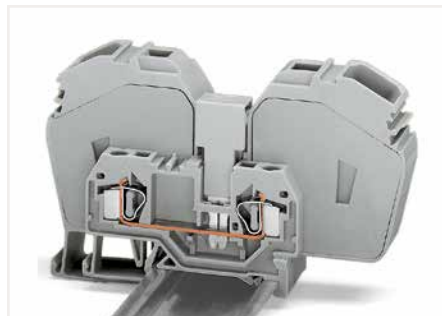

Commoning a 285 Series Terminal Block (35 mm<sup>2</sup> / 2 AWG) with a 281 Series Terminal Block (4 mm<sup>2</sup> / 12 AWG) using a step-down jumper (283-414).

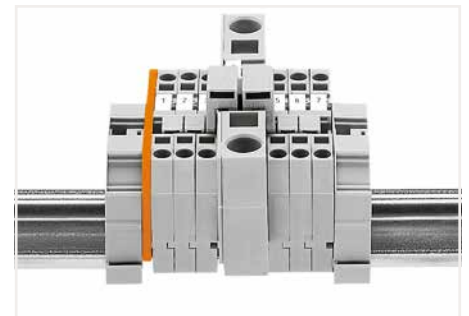

Finger guard seals an unused conductor entry.

**Step-down jumpers (overview):**

Description	Item No.	PU
from 10/6 mm <sup>2</sup> to 4/2.5/1.5 mm <sup>2</sup>	284-414	50
from 16 to 4 mm <sup>2</sup>	283-414	50
from 10/6 to 6/4 mm <sup>2</sup>	284-413	50

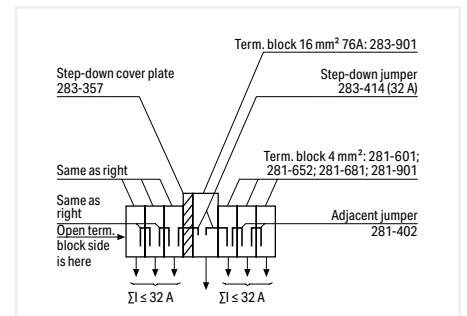

The following 285 Series Through Terminal Blocks can be commoned with 283 Series Through Terminal Blocks: 285-635 or 285-634 with 283-601 or 283-604 (terminal blocks with side marking, visit [www.wago.com](http://www.wago.com))  
Adjacent jumper required: 285-435

Please note that the nominal current of the adjacent jumper must not exceed 63 A.

- ① Conductor range: 0.2 ... 16 mm<sup>2</sup>; 24 ... 6 AWG; Strip length: 16 ... 17 mm / 0.63 ... 0.67 inch
  - ② Conductor range: 6 ... 35 mm<sup>2</sup>; 8 ... 2 AWG; Strip length: 23 mm / 0.91 inch
- Accessories: see page 96

- ③ 800/1000 V = rated voltage; 8 kV = rated impulse voltage; 3 = pollution degree
  - ④ Suitable for Ex e II applications; 550 V; 68 A
  - ⑤ Suitable for Ex e II applications; 880 V; 85 A
- Marking: WMB/WMB Inline/Marking strips
- Suitable operating tool: see page 279

# WAGO Double-Deck Terminal Block – 279/280/281 Series

## 1,5 / 2,5 / 4 mm<sup>2</sup>

Image	Description	Color	Item No.	PU	Potential Marking	Electrical Data
<b>Double-deck terminal block; 1.5 mm<sup>2</sup> ①</b>						
	Through/through terminal block	○ gray	279-501	50	L/L	500 V/6 kV/3 ⑥; I <sub>n</sub> 18 A; 300 V, 10 A ⑨
		○ gray	279-512	50	N/L	
	Ground/through terminal block	○ gray	279-513	50	L/N	
		● blue	279-504 ⑦	50	N/N	
	4-conductor through terminal block; internally commoned; violet conductor entry	○ gray	279-517	50	GND/N	
		○ gray	279-527	50	GND/L	
4-conductor ground terminal block; internally commoned	○ gray	279-508	50	L		
	● blue	279-509 ⑦	50	N		
	End and intermediate plate; 2 mm thick	● green-yellow	279-507	50	GND	
		● orange	279-519	25		
		○ gray	279-518	25		
<b>Double-deck terminal block; 2.5 mm<sup>2</sup> ②</b>						
	Through/through terminal block	○ gray	280-519	50		500 V/6 kV/3 ⑥; I <sub>n</sub> 20 A; 300 V, 15 A ⑨; 300 V, 20 A ⑩
		● blue	280-529 ⑦	50		
	Ground/through terminal block	■ blue/gray	280-523	50		
		■ gray/blue	280-533	50		
4-conductor ground terminal block; internally commoned	■ green-yellow/gray	280-527	50			
	■ green-yellow/gray	280-537	50			
	End and intermediate plate; 2 mm thick	● green-yellow	280-517	50		
		● orange	280-341	25		
		○ gray	280-340	25		
<b>Double-deck terminal block; with slot for adjacent jumper; 2.5 mm<sup>2</sup> ③</b>						
	Through/through terminal block; with slot for adjacent jumper	○ gray	280-520	50		500 V/6 kV/3 ⑥; I <sub>n</sub> 20 A; 300 V, 15 A ⑨; 300 V, 20 A ⑩
		● blue	280-530 ⑦	50		
		■ blue/gray	280-524	50		
		■ gray/blue	280-534	50		
	End and intermediate plate; 2 mm thick	● orange	280-343	25		
		○ gray	280-342	25		
<b>Double-deck terminal block; 4 mm<sup>2</sup> ④</b>						
	Through/through terminal block	○ gray	281-619	50		500 V/6 kV/3 ⑥; I <sub>n</sub> 26 A; 600 V, 20 A ⑨; 600 V, 25 A ⑩
		● blue	281-629	50		
	End and intermediate plate; 2.5 mm thick	● orange	281-341	25		
		○ gray	281-340	25		
<b>Double-deck terminal block; with slot for adjacent jumper; 4 mm<sup>2</sup> ⑤</b>						
	Through/through terminal block; with slot for adjacent jumper	○ gray	281-620	50		500 V/6 kV/3 ⑥; I <sub>n</sub> 26 A; 600 V, 20 A ⑨; 600 V, 25 A ⑩
		● blue	281-630	50		
	End and intermediate plate; 2.5 mm thick	● orange	281-343	25		
		○ gray	281-342	25		

① Dimensions (W x H x D):  
4 x 39 x 85 mm / 0.157 x 1.54 x 3.35 inch;  
Conductor range: 0.08 ... 1.5 mm<sup>2</sup> 28 ... 16 AWG;  
Strip length: 8 ... 9 mm / 0.31 ... 0.35 inch

② Dimensions (W x H x D):  
5 x 58.5 x 64 mm / 0.197 x 2.3 x 2.52 inch;  
Conductor range: 0.08 ... 2.5 mm<sup>2</sup> 28 ... 12 AWG;  
Strip length: 8 ... 9 mm / 0.31 ... 0.35 inch

③ Dimensions (W x H x D):  
5 x 58.5 x 74 mm / 0.197 x 2.3 x 2.91 inch;  
Conductor range: 0.08 ... 2.5 mm<sup>2</sup> 28 ... 12 AWG;  
Strip length: 8 ... 9 mm / 0.31 ... 0.35 inch

④ Dimensions (W x H x D):  
6 x 58.5 x 73.5 mm / 0.236 x 2.3 x 2.89 inch;  
Conductor range: 0.08 ... 4 mm<sup>2</sup> 28 ... 12 AWG;  
Strip length: 9 ... 10 mm / 0.35 ... 0.39 inch

⑤ Dimensions (W x H x D):  
6 x 58.5 x 83.5 mm / 0.236 x 2.3 x 3.29 inch;  
Conductor range: 0.08 ... 4 mm<sup>2</sup> 28 ... 12 AWG;  
Strip length: 9 ... 10 mm / 0.35 ... 0.39 inch

⑥ 500 V = rated voltage  
6 kV = rated impulse voltage  
3 = pollution degree

⑦ Suitable for Ex i applications

Accessories: see page 96







Marking: WMB/WMB Inline/Marking strips

Suitable operating tool: see page 279



# WAGO Triple-Deck Terminal Block; Quadruple-Deck Rail-Mount Terminal Block for Electric Motor Wiring – 280/281 Series

## 2,5 / 4 mm<sup>2</sup>

Image	Description	Color	Item No.	PU	Potential Marking	Electrical Data
<b>Triple-deck terminal block; 2.5 mm<sup>2</sup> ①</b>						
	Through/through/through terminal block	○ gray ● blue ■ gray/gray/blue	280-549 280-551 280-552	40 40 40		500 V/6 kV/3 ④; I <sub>N</sub> 20 A; 300 V, 15 A ⑤; 300 V, 20 A ⑥
	Ground/through/through terminal block	■ green-yellow/gray/blue ■ green-yellow/blue/gray	280-547 280-557	40 40		
	Shield/through/through terminal block	■ white/gray/blue ■ white/blue/gray	280-548 280-558	40 40		
	6-conductor ground terminal block; internally commoned	● green-yellow	280-597	40		
		End and intermediate plate; 2 mm thick	● orange	280-304	25	
○ gray			280-303	25		
<b>Triple-deck terminal block; with slot for adjacent jumper; 2.5 mm<sup>2</sup> ②</b>						
	Through/through/through terminal block with additional jumper position on lower level	○ gray	280-550	40		500 V/6 kV/3 ④; I <sub>N</sub> 20 A; 300 V, 15 A ⑤; 300 V, 20 A ⑥
		End and intermediate plate; 2 mm thick	● orange	280-306	25	
○ gray			280-305	25		
<b>Quadruple-deck rail-mount terminal block for electric motor wiring; 4 mm<sup>2</sup> ③</b>						
	Quadruple-deck rail-mount terminal block; Rail-mount terminal block for electric motor wiring	○ gray	281-530	50	L1 - L2 - L3 - GND	400 V/6 kV/3 ④; I <sub>N</sub> 20 A; 600 V, 20 A ⑤; 300 V, 25 A ⑥
		○ gray	281-531	50	L1 - L2	
		○ gray	281-532	50	L1 - L2 - L3	
	End and intermediate plate; 2 mm thick	● orange	281-366	25		
		○ gray	281-365	25		

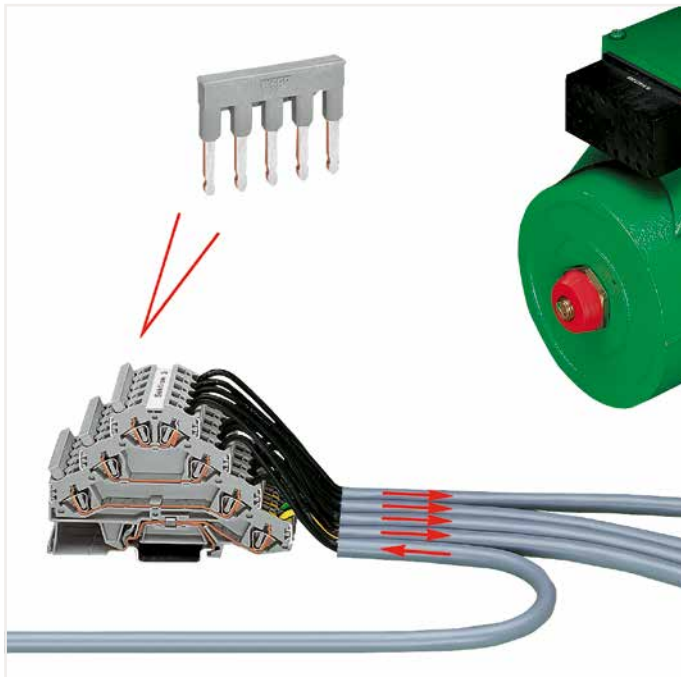

In addition to rail-mount terminal blocks for electric motor wiring, special versions are also available:

- Version **without** ground contact and only two potentials:  
These terminal blocks were custom designed to support additional functions, such as engine brakes or temperature sensors. Sharing a common profile, this terminal block version can be put next to the appropriate electric motor wiring terminal block without using intermediate plates. That makes the rail assembly easier to understand and wire. This also prevents wiring errors as no conductor entry is unused.
- Version **without** ground contact and with three potentials:  
Clearly designated clamping units are the primary advantage to this terminal block design. When using devices with protective insulation, for example, there are no open ground clamping units that could create confusion.

① Dimensions (W x H x D):  
4 x 39 x 85 mm / 0.157 x 1.54 x 3.35 inch;  
Conductor range: 0.08 ... 1.5 mm<sup>2</sup> 28 ... 16 AWG;  
Strip length: 8 ... 9 mm / 0.31 ... 0.35 inch

② Dimensions (W x H x D):  
5 x 58.5 x 74 mm / 0.197 x 2.3 x 2.91 inch;  
Conductor range: 0.08 ... 2.5 mm<sup>2</sup> 28 ... 12 AWG;  
Strip length: 8 ... 9 mm / 0.31 ... 0.35 inch

③ Dimensions (W x H x D):  
6 x 58.5 x 83.5 mm / 0.236 x 2.3 x 3.29 inch;  
Conductor range: 0.08 ... 4 mm<sup>2</sup> 28 ... 12 AWG;  
Strip length: 9 ... 10 mm / 0.35 ... 0.39 inch

④ 400/500 V = rated voltage;  
6 kV = rated impulse voltage;  
3 = pollution degree













Accessories: see page 96

Marking: WMB/WMB Inline/Marking strips

Suitable operating tool: see page 279

# WAGO Rail-Mount Terminal Block with Side-Entry Wiring – 279/280/281/282/283/284 Series

## 1,5 / 2,5 / 4 / 6 / 10 / 16 mm<sup>2</sup>

Image	Description	Color	Item No.	PU	Dimensions (W x H x D)	Electrical Data
<b>2-conductor through terminal block; 4 mm<sup>2</sup> ①</b>						
	2-conductor through terminal block	○ gray	279-101	100	4 x 30,5 x 42,5 mm / 0.16 x 1.2 x 1.67 inch	800 V/8 kV/3 ⑥; I <sub>n</sub> 18 A; 600 V, 10 A ⑦; 600 V, 15 A ⑧
	2-conductor through terminal block	● blue	279-104 ⑦	100		
	End and intermediate plate; 2.5 mm thick	● orange	280-302	25	2,5 x 30 x 38 mm /	
		○ gray	280-301	25	0.1 x 1.18 x 1.5 inch	
<b>2-conductor through terminal block; 5 mm<sup>2</sup> ②</b>						
	2-conductor through terminal block	○ gray	280-101	100	5 x 30,5 x 42,5 mm / 0.2 x 1.2 x 1.67 inch	800 V/8 kV/3 ⑥; I <sub>n</sub> 24 A; 600 V, 20 A ⑦; 600 V, 20 A ⑧
	2-conductor through terminal block	● blue	280-104 ⑦	100		
	2-conductor ground terminal block	● yellow-green	280-107	100		
	End and intermediate plate; 2.5 mm thick	● orange	280-302	25	2,5 x 30 x 38 mm /	
		○ gray	280-301	25	0.1 x 1.18 x 1.5 inch	
<b>2-conductor through terminal block; 6 mm<sup>2</sup> ③</b>						
	2-conductor through terminal block	○ gray	281-101	100	6 x 32,5 x 42,5 mm / 0.24 x 1.28 x 1.67 inch	800 V/8 kV/3 ⑥; I <sub>n</sub> 32 A; 600 V, 20 A ⑦; 600 V, 25 A ⑧
	2-conductor through terminal block	● blue	281-104 ⑦	100		
	2-conductor ground terminal block	● yellow-green	281-107	100		
	End and intermediate plate; 3 mm thick	● orange	281-302	25	3 x 32 x 40 mm /	
		○ gray	281-301	25	0.12 x 1.26 x 1.56 inch	
<b>2-conductor through terminal block; 8 mm<sup>2</sup> ④</b>						
	2-conductor through terminal block	○ gray	282-101	50	8 x 37 x 46,5 mm / 0.32 x 1.46 x 1.83 inch	800 V/8 kV/3 ⑥; I <sub>n</sub> 41 A; 600 V, 30 A ⑦; 600 V, 10 A ⑧
	2-conductor through terminal block	● blue	282-104 ⑦	50		
	2-conductor ground terminal block	● yellow-green	282-107	50		
	End and intermediate plate; 4 mm thick	● orange	282-302	25	4 x 36,5 x 46 mm /	
		○ gray	282-301	25	0.16 x 1.44 x 1.81 inch	
<b>2-conductor through terminal block; 10 mm<sup>2</sup> ⑤</b>						
	2-conductor through terminal block	○ gray	284-101	50	10 x 41,5 x 52 mm / 0.4 x 1.63 x 2.05 inch	800 V/8 kV/3 ⑥; I <sub>n</sub> 57 A; 600 V, 50 A ⑦; 600 V, 65 A ⑧
	2-conductor through terminal block	● blue	284-104 ⑦	50		
	2-conductor ground terminal block	● yellow-green	284-107	50		
	End and intermediate plate; 2.5 mm thick	● orange	284-302	25	2,5 x 40 x 52 mm /	
		○ gray	284-301	25	0.1 x 1.56 x 2.05 inch	
<b>2-conductor through terminal block; 16 mm<sup>2</sup> ⑥</b>						
	2-conductor through terminal block	○ gray	283-101	50	12 x 45,5 x 58 mm / 0.47 x 1.79 x 2.28 inch	800 V/8 kV/3 ⑥; I <sub>n</sub> 76 A; 600 V, 65 A ⑦; 600 V, 90 A ⑧
	2-conductor through terminal block	● blue	283-104 ⑦	50		
	2-conductor ground terminal block	● yellow-green	283-107	50		
	End and intermediate plate; 4 mm thick	● orange	283-302	25	4 x 44 x 58 mm /	
		○ gray	283-301	25	0.16 x 1.73 x 2.28 inch	

① Conductor range: 0.08 ... 1.5 mm<sup>2</sup>; 28 ... 16 AWG;  
Strip length: 8 ... 9 mm / 0.31 ... 0.35 inch

② Conductor range: 0.08 ... 2.5 mm<sup>2</sup>; 28 ... 12 AWG;  
Strip length: 8 ... 9 mm / 0.31 ... 0.35 inch

③ Conductor range: 0.08 ... 4 mm<sup>2</sup>; 28 ... 12 AWG;  
Strip length: 9 ... 10 mm / 0.35 ... 0.39 inch

Accessories: see page 96

④ Conductor range: 0.2 ... 6 mm<sup>2</sup>; 24 ... 10 AWG;  
Strip length: 12 ... 13 mm / 0.47 ... 0.51 inch

⑤ Conductor range: 0.2 ... 10 mm<sup>2</sup>; 24 ... 8 AWG;  
Strip length: 12 ... 13 mm / 0.47 ... 0.51 inch

⑥ Conductor range: 0.2 ... 16 mm<sup>2</sup>; 24 ... 6 AWG;  
Strip length: 16 ... 17 mm / 0.63 ... 0.67 inch

Marking: WMB/WMB Inline/Marking strips

⑥ 800 V = rated voltage  
8 kV = rated impulse voltage  
3 = pollution degree

⑦ Suitable for Ex i applications

Suitable operating tool: see page 279

# WAGO Disconnect/Test/Fuse Terminal Block with Side-Entry Wiring – 282 Series

## 6 mm<sup>2</sup>

Image	Description	Color	Item No.	PU	Dimensions (W x H x D)	Electrical Data
<b>Disconnect/test terminal block</b>						
	Disconnect/test terminal block; with 4 mm Ø test sockets	○ gray	282-131	25	8 x 37 x 87,5 mm / 0.32 x 1.46 x 3.44 inch	400 V/6 kV/3 ①; I <sub>n</sub> 41 A; 300 V, 30 A ②; 300 V, 40 A ③
	Through terminal block	○ gray	282-133	25		
	Disconnect/test terminal block; without test sockets	○ gray	282-135	25		
	Ground conductor disconnect terminal block ② (For additional notes, see page 47.)					
	24 VAC/DC	○ gray	282-140	12	16 x 38,5 x 87,5 mm / 0.63 x 1.52 x 3.44 inch	
	48 VAC/DC	○ gray	282-141	12		
	120 VAC/DC	○ gray	282-138	12		
	230 VAC/VDC	○ gray	282-139	12		
	Lock-out; prevents reclosing of slide link; snap-on type	● orange	282-137	25		
	End and intermediate plate; 4 mm thick	● orange	282-315	25	4 x 37 x 85 mm /	
		○ gray	282-314	25	0.16 x 1.46 x 3.35 inch	
<b>Fuse terminal block</b>						
	2-conductor fuse terminal block; for 5 x 20 mm glass cartridge fuses; without indicator	○ gray	282-122	40	13 x 54,5 x 62 mm / 0.51 x 2.15 x 2.44 inch	500 V/6 kV/3 ①; I <sub>n</sub> 10 A; 600 V, 10 A ②; 250 V, 10 A ③
	2-conductor fuse terminal block, for 1/4" x 1" cartridge fuses; without indicator	○ gray	282-120	40	13 x 56,5 x 62 mm / 0.51 x 2.22 x 2.44 inch	
	2-conductor fuse terminal block, for 1/4" x 1 1/4" cartridge fuses; without indicator	○ gray	282-128	40	13 x 56,5 x 62 mm / 0.51 x 2.22 x 2.44 inch	
	2-conductor fuse terminal block; for 5 x 25 mm glass cartridge fuses; with indicator	○ gray	282-126	40	13 x 54,5 x 62 mm / 0.51 x 2.15 x 2.44 inch	
	2-conductor fuse terminal block; for 1/4" x 1 1/4" glass cartridge fuses; with red LED	○ gray	282-128/281-413	40	13 x 56,5 x 62 mm / 0.51 x 2.22 x 2.44 inch	
	2-conductor fuse terminal block; for 1/4" x 1 1/4" glass cartridge fuses; with 250 VAC/220 VDC neon lamp	○ gray	282-128/281-417	40	13 x 56,5 x 62 mm / 0.51 x 2.22 x 2.44 inch	
	2-conductor fuse terminal block; for (5 x 20) mm glass cartridge fuses; with 250 VAC/220 VDC neon lamp	○ gray	282-124	40	13 x 54,5 x 62 mm / 0.51 x 2.15 x 2.44 inch	
	22-conductor fuse terminal block; for 1/4" x 1 1/4" glass cartridge fuses; with 120 VAC/DC neon lamp	○ gray	282-128/281-418	40	13 x 56,5 x 62 mm / 0.51 x 2.22 x 2.44 inch	
	End and intermediate plate; 4 mm thick	● orange	282-312	25	4 x 46,4 x 62 mm /	
		○ gray	282-311	25	0.16 x 1.83 x 2.44 inch	

1

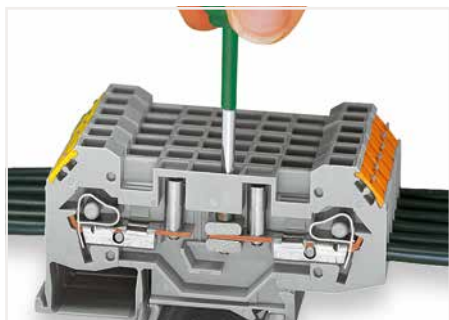

Shifting the disconnect slide link of a disconnect/test terminal block.

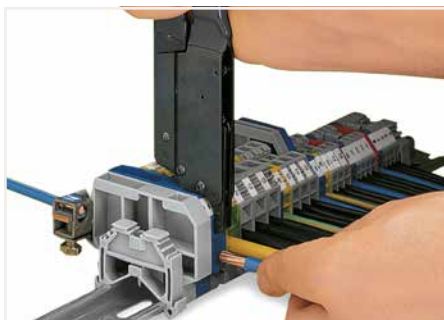

When operating the handles beyond the locked position, the ratchet allows the tool to open and be removed from the terminal block.



Commoning from 6 mm<sup>2</sup>/10 AWG (282 Series) to 1.5 mm<sup>2</sup>/16 AWG (279 Series) rail-mount terminal blocks via step-down jumpers.

Conductor range: 0.2 ... 6 mm<sup>2</sup>; 24 ... 10 AWG;  
Strip length: 12 ... 13 mm / 0.47 ... 0.51 inch

Accessories: see page 96

① 400/500 V = rated voltage;  
8 kV = rated impulse voltage;  
3 = pollution degree

Marking: WMB/WMB Inline/Marking strips

② Nominal voltage and current are given by the fuse or blown fuse indicator!

Suitable operating tool: see page 279

# WAGO Disconnect/Test Terminal Block; WAGO Through Terminal Block of Same Profile; WAGO Ground Conductor Disconnect Terminal Block 2,5 / 6 mm<sup>2</sup>; Serie 280 / 282

1

Image	Description	Color	Item No.	PU	Dimensions (W x H x D)	Electrical Data
<b>2-conductor disconnect/test terminal block; 2.5 mm<sup>2</sup> ①</b>						
	2-conductor disconnect/test terminal block; with test slots for 2 and 2.3 mm Ø test plugs; with pivoting knife disconnect	○ gray	280-870	100	5 x 45,5 x 69,5 mm / 0.2 x 1.79 x 2.74 inch	400 V/6 kV/3 ③; I <sub>N</sub> 16 A; 600 V, 15 A ⑤; 300 V, 15 A ⑥
		○ gray	280-868	100		
		● blue ④	280-876	100		
		● orange	280-879	100		
	2-conductor disconnect/test terminal block; with test slots for 2 and 2.3 mm Ø test plugs; with pivoting knife disconnect	○ gray	280-871	100	5 x 45,5 x 82 mm / 0.2 x 1.79 x 3.23 inch	250 V/4 kV/3 ③; I <sub>N</sub> 16 A; 600 V, 15 A ⑤; 300 V, 15 A ⑥
		○ gray	280-869	100		
		● blue	280-880	100		
	End and intermediate plate; 2.5 mm thick	● orange	280-371	25	2,5 x 28,5 x 69,4 mm / 01 x 1.12 x 2.73 inch	
		○ gray	280-374	25		
<b>4-conductor disconnect/test terminal block; 2.5 mm<sup>2</sup> ①</b>						
	4-conductor disconnect/test terminal block; with test slots for 2 and 2.3 mm Ø test plugs; with pivoting knife disconnect	○ gray	280-874	100	5 x 45,5 x 89 mm / 0.2 x 1.79 x 3.5 inch	400 V/6 kV/3 ③; I <sub>N</sub> 16 A; 600 V, 15 A ⑤; 300 V, 15 A ⑥
		○ gray	280-881	100		
		● blue ④	280-885	100		
		● orange	280-883	100		
	4-conductor disconnect/test terminal block; with test slots for 2 and 2.3 mm Ø test plugs; with pivoting knife disconnect	○ gray	280-875	100	5 x 45,5 x 101 mm / 0.2 x 1.79 x 3.98 inch	250 V/4 kV/3 ③; I <sub>N</sub> 16 A; 600 V, 15 A ⑤; 300 V, 15 A ⑥
		○ gray	280-882	100		
		● blue	280-884	100		
	End and intermediate plate; 2.5 mm thick	● orange	280-373	25	2,5 x 28,5 x 88,9 mm / 01 x 1.12 x 3,5 inch	
		○ gray	280-376	25		
<b>Disconnect and ground conductor disconnect terminal block; 6 mm<sup>2</sup> ②</b>						
	2-conductor disconnect terminal block; with test point	○ gray	282-697	25	8 x 50,5 x 85 mm / 0.32 x 1.99 x 3.35 inch	400 V/6 kV/3 ③; I <sub>N</sub> 30 A; 600 V, 30 A ⑤; 300 V, 35 A ⑥
		● blue	282-695	25		
	3-conductor through terminal block; with test point; same profile as disconnect terminal blocks	○ gray	282-699	25	8 x 32,5 x 85 mm / 0.32 x 1.28 x 3.35 inch	800 V/8 kV/3 ③; I <sub>N</sub> 41 A; 600 V, 30 A ⑤; 300 V, 35 A ⑥
		● blue	282-694	25		
	Ground conductor disconnect terminal block; with test point ⑤ (For additional notes, see page 47.)	○ gray	282-640	12	16 x 32,5 x 85 mm / 0.32 x 1.28 x 3.35 inch	
		○ gray	282-641	12		
		○ gray	282-638	12		
		○ gray	282-639	12		
	End and intermediate plate; 2 mm thick	● orange	282-333	25	2 x 26,1 x 84,5 mm / 0.08 x 1.03 x 3.33 inch	
		○ gray	282-334	25		

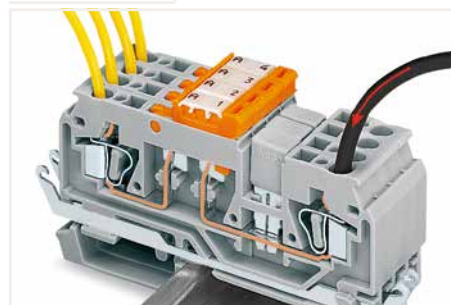

Power distribution using an adjacent jumper – knife disconnect used to disconnect individual outputs.

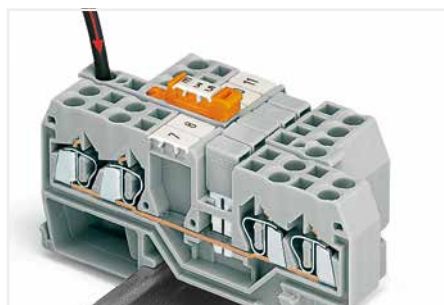

Power distribution using disconnect link in supply line – disconnection of all outputs.

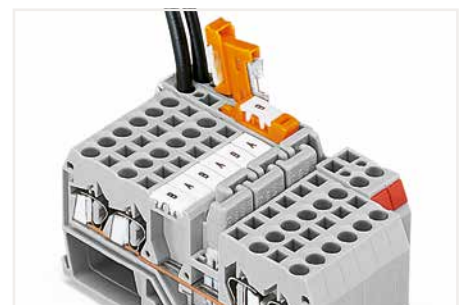

Staggered jumpers for sophisticated circuit requirements – push jumpers down until fully inserted.

① Conductor range: 0.08 ... 2.5 mm<sup>2</sup>; 28 ... 12 AWG;  
Strip length: 8 ... 9 mm / 0.31 ... 0.35 inch

② Conductor range: 0.2 ... 6 mm<sup>2</sup>; 24 ... 10 AWG;  
Strip length: 12 ... 13 mm / 0.47 ... 0.51 inch

Accessories: see page 96

③ 400/800 V = rated voltage;  
6/8 kV = rated impulse voltage;  
3 = pollution degree

















④ Suitable for Ex i applications

Marking: WMB/WMB Inline/Marking strips

⑤ Nominal voltage and current are given by the fuse or blown fuse indicator!

Suitable operating tool: see page 279

## WAGO Disconnect/Test/Through Terminal Block; for Current/Voltage Transformer Circuits 6 mm<sup>2</sup>; 282 Series

Image	Description	Color	Item No.	PU	Dimensions (W x H x D)	Electrical Data
<b>2-conductor disconnect/test and through terminal block for current/ voltage transformer circuits</b>						
	2-conductor disconnect/test terminal block; transverse switching; with touch-proof test socket; for 4 mm Ø test plug	○ gray	282-811	20	8 x 37,5 x 89 mm / 0.32 x 1.48 x 3.5 inch	500 V/6 kV/3 ①; I <sub>N</sub> 30 A; 600 V, 30 A ②; 300 V, 36 A ③
	Jumper with safety flap; insulated; I <sub>N</sub> 30 A					
	2-way	● orange	282-432/100-000	10		
	3-way	● orange	282-433/100-000	10		
	4-way	● orange	282-434/100-000	10		
	End and separator plate; 1.5 mm thick	● orange ○ gray	282-366 282-361	25 25	1,5 x 37,5 x 89 mm / 0.06 x 1.48 x 3.5 inch	
	2-conductor disconnect/test terminal block; longitudinal switching; with touch-proof test sockets; for 4 mm Ø test plugs	○ gray	282-821	20		500 V/6 kV/3 ①; I <sub>N</sub> 30 A; 600 V, 30 A ②; 300 V, 36 A ③
	2-conductor through terminal block; with touch-proof test sockets; for 4 mm Ø test plugs	○ gray	282-841	20	8 x 46,5 x 98 mm / 0.32 x 1.83 x 3.86 inch	500 V/6 kV/3 ①; I <sub>N</sub> 30 A
	2-conductor through terminal block; without test sockets	○ gray	282-841/049-000	20		
	End and separator plate; 1.5 mm thick	● orange ○ gray	282-365 282-360	25 25	1,5 x 46,5 x 98 mm / 0.06 x 1.83 x 3.86 inch	
<b>3-conductor disconnect/test and through terminal block for current/ voltage transformer circuits</b>						
	3-conductor disconnect/test terminal block; with touch-proof test sockets; for 4 mm Ø test plugs; e.g., for current transformer circuits; orange disconnect link	○ gray	282-870	20	8 x 75 x 122 mm / 0.32 x 2.95 x 4.8 inch	500 V/6 kV/3 ①; I <sub>N</sub> 30 A; 600 V, 30 A ②; 300 V, 5 A ③
	Adjacent jumper; insulated	● orange	282-424	25		I <sub>N</sub> 41 A
	3-conductor disconnect/test terminal block; with touch-proof test sockets; for 4 mm Ø test plugs; e.g., for voltage transformer circuits; light gray disconnect link	○ gray	282-860	20	8 x 75 x 122 mm / 0.32 x 2.95 x 4.8 inch	500 V/6 kV/3 ①; I <sub>N</sub> 30 A; 600 V, 30 A ②; 300 V, 5 A ③
	End and separator plate; 1.5 mm thick; without lock-out seal option	● orange ○ gray	282-386 282-391	10 10	1,5 x 71,7 x 122 mm / 0.06 x 2.82 x 4.8 inch	
	End and separator plate; 1.5 mm thick; with lock-out seal option	● orange ○ gray	282-387 282-392	10 10		
	3-conductor through terminal block; with touch-proof test socket; for 4 mm Ø test plugs; e.g., for current transformer circuits	○ gray	282-865	20		500 V/6 kV/3 ①; I <sub>N</sub> 30 A; 600 V, 30 A ②; 300 V, 5 A ③
	3-conductor through terminal block; with touch-proof test socket; for 4 mm Ø test plugs; e.g., for voltage transformer circuits	○ gray	282-866	20	8 x 74 x 122 mm / 0.32 x 2.91 x 4.8 inch	
	3-conductor through terminal block; with touch-proof test socket; for 4 mm Ø test plugs; e.g., for voltage transformer circuits	● green-yellow	282-868	20		
	End and intermediate plate; 1.5 mm thick	● orange ○ gray	282-385 282-390	10 10	1,5 x 65,6 x 122 mm / 0.06 x 2.58 x 4.8 inch	

Conductor range: 0.2 ... 6 mm<sup>2</sup>; 24 ... 10 AWG;  
Strip length: 12 ... 13 mm / 0.47 ... 0.51 inch

① 500 V = rated voltage  
6 kV = rated impulse voltage  
3 = pollution degree

Accessories: see page 96  
Marking: WMB/WMB Inline/Marking strips  
Suitable operating tool: see page 279

# WAGO Fused Terminal Blocks with a Pivoting Fuse Holder; WAGO Fuse Terminal Blocks for Mini-Automotive Blade-Style Fuses; Fuse Terminal Blocks for Cylindrical Fuses; 282/811 Series Description and Installation

1



Blown fuse indication by LED or neon lamp



**Fuse replacement:**  
One end of the fuse is automatically ejected from the holder when opening the cover.



Storing a spare fuse (fuse holder without blown fuse indication).

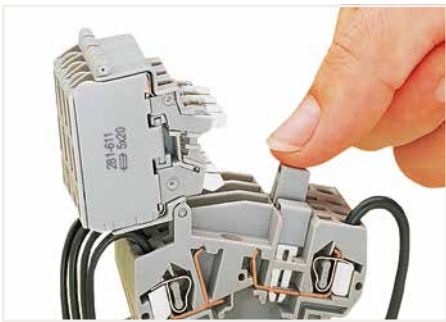

**Commoning**  
Distributing current to several fuse-protected circuits via insulated push-in type jumpers.

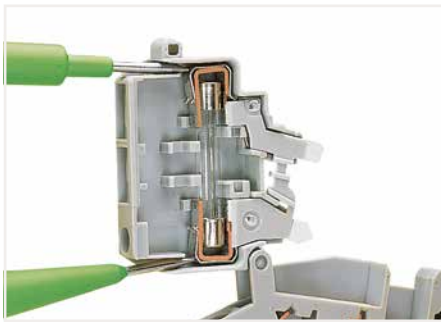

Through test with fuse holder in open position (no voltage)



Measuring current between jumper slot and separate test slot.

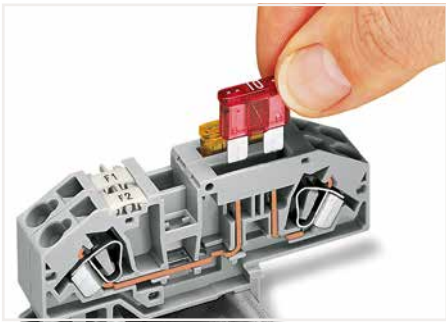

Inserting a fuse.



Blown fuse indication via LED.

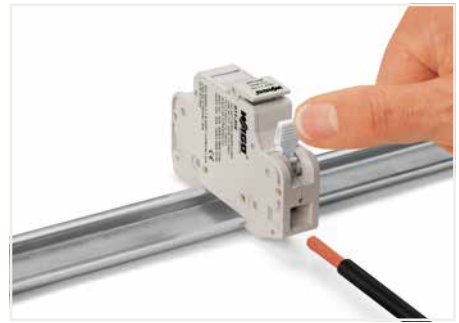

**CAGE CLAMP® connection**  
Inserting a conductor.  
Opening the clamping unit via integrated lever.



WMB marker slot for convenient identification



Inserting a fuse.



Creating a 2- or 3-pole fuse terminal block via coupling kit.

# WAGO Sensor Terminal Blocks and WAGO Actuator Terminal Blocks

## 280 Series

### Description and Installation

1

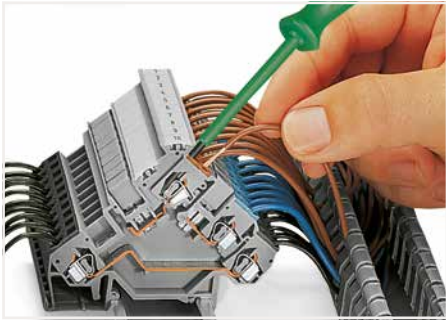

**CAGE CLAMP® connection**  
Inserting a conductor via straight operating tool (210-720).

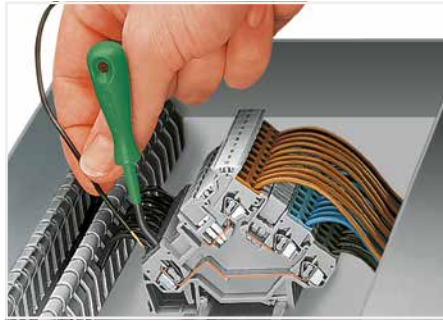

**CAGE CLAMP® connection**  
Inserting a conductor via angled operating tool (210-658).

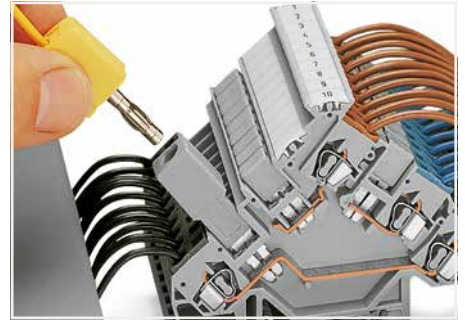

Testing via banana plug and test plug adapter (209-170).

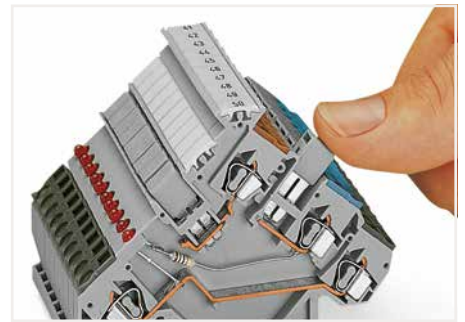
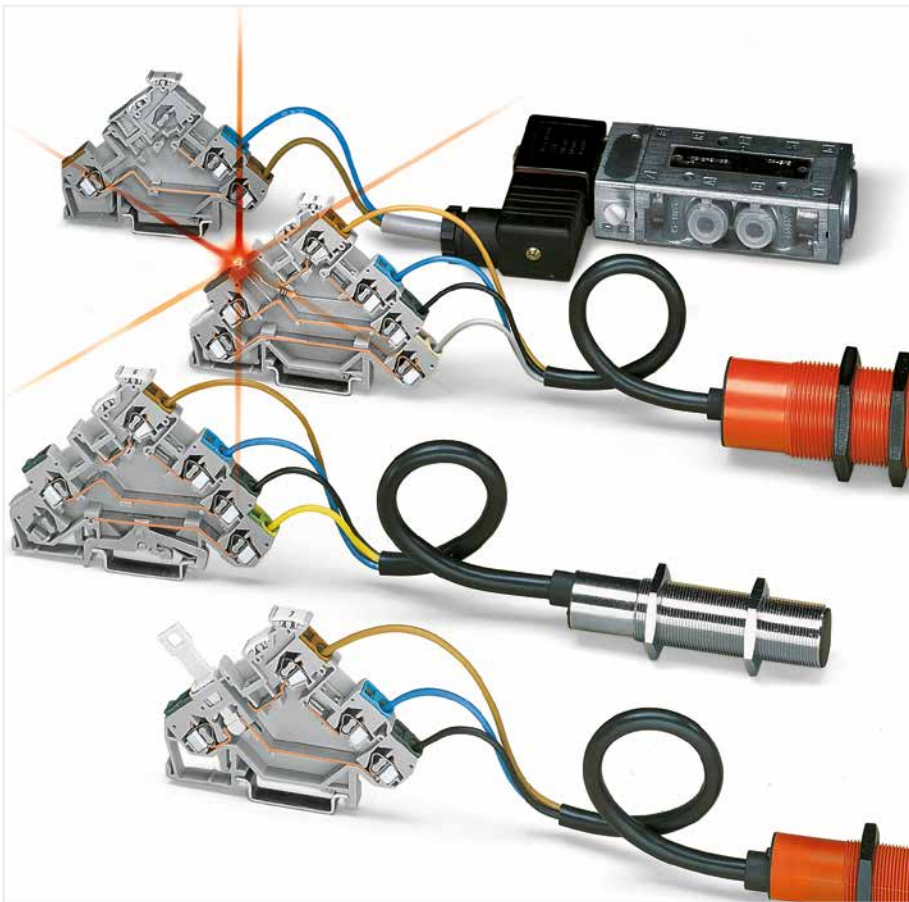

Commoning using an adjacent jumper (280-402).  
Push jumper down until fully inserted.

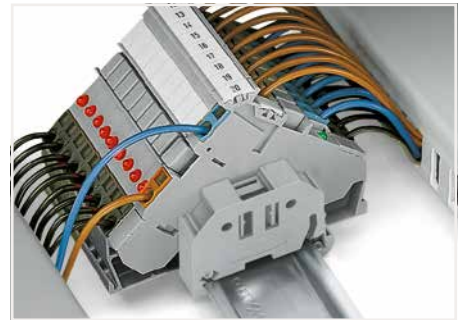

Sensor terminal blocks  
Power supply from control panel side



Sensor terminal blocks  
Power supply from sensor side



Testing via voltage tester directly on the current bar.



Actuator terminal blocks with fuse holders (281-511) –  
intermediate plates are required!

# WAGO Fuse terminal block

## 4/6 mm<sup>2</sup>; 281/282 Series

1

Image	Description	Color	Item No.	PU	Dimensions (W x H x D)	Electrical Data
<b>Fused disconnect terminal block with a pivoting fuse holder ①</b>						
	Fused disconnect terminal block with a pivoting fuse holder; without blown fuse indication					
	for (5 x 20) mm glass cartridge fuse	○ gray	281-611	50		
	for (5 x 20) mm glass cartridge fuse	● orange	281-616	50	8 x 60 x 60 mm / 0.32 x 2.36 x 2.36 inch	800 V/8 kV/3 ④; I <sub>n</sub> 10 A; 600 V, 10 A ⑤; 600 V, 10 A ⑥
	for (5 x 25) mm glass cartridge fuse	○ gray	281-612	50		
	for (5 x 30) mm glass cartridge fuse	○ gray	281-622	50		
	for 1/4" x 1" glass cartridge fuse	○ gray	281-613	50	10 x 60 x 60 mm / 0.39 x 2.36 x 2.36 inch	
for 1/4" x 1 1/4" glass cartridge fuse	○ gray	281-623	50			
	Fused disconnect terminal block with a pivoting fuse holder; with blown fuse indication by LED					
	for (5 x 20) mm glass cartridge fuse; 15 ... 30 V	○ gray	281-611/281-541	50		
	for (5 x 20) mm glass cartridge fuse; 30 ... 65 V	○ gray	281-611/281-542	50	8 x 60 x 60 mm / 0.32 x 2.36 x 2.36 inch	800 V/8 kV/3 ④; I <sub>n</sub> 10 A; 30 V, 10 A ⑤; 230 V, 10 A ⑥
	for (5 x 25) mm glass cartridge fuse; 15 ... 30 V	○ gray	281-612/281-541	50		
	for (5 x 25) mm glass cartridge fuse; 30 ... 65 V	○ gray	281-612/281-542	50		
	for (5 x 30) mm glass cartridge fuse; 15 ... 30 V	○ gray	281-622/281-541	50		
	for (5 x 30) mm glass cartridge fuse; 30 ... 65 V	○ gray	281-622/281-542	50		
	for 1/4" x 1" glass cartridge fuse; 15 ... 30 V	○ gray	281-613/281-541	50	10 x 60 x 60 mm / 0.39 x 2.36 x 2.36 inch	800 V/8 kV/3 ④; I <sub>n</sub> 10 A; 30 V, 10 A ⑤; 30 V, 10 A ⑥
	for 1/4" x 1" glass cartridge fuse; 30 ... 65 V	○ gray	281-613/281-542	50		
	for 1/4" x 1 1/4" glass cartridge fuse; 15 ... 30 V	○ gray	281-623/281-541	50		
for 1/4" x 1 1/4" glass cartridge fuse; 30 ... 65 V	○ gray	281-623/281-542	50			
	Fused disconnect terminal block with a pivoting fuse holder; with blown fuse indication by neon lamp					
	for (5 x 20) mm glass cartridge fuse; 230 V	○ gray	281-611/281-417	50		
	for (5 x 20) mm glass cartridge fuse; 120 V	○ gray	281-611/281-418	50	8 x 60 x 60 mm / 0.32 x 2.36 x 2.36 inch	800 V/8 kV/3 ④; I <sub>n</sub> 10 A; 220 V, 10 A ⑤; 230 V, 10 A ⑥
	for (5 x 25) mm glass cartridge fuse; 230 V	○ gray	281-612/281-417	50		
	for (5 x 25) mm glass cartridge fuse; 120 V	○ gray	281-612/281-418	50		
	for (5 x 30) mm glass cartridge fuse; 230 V	○ gray	281-622/281-417	50		
	for (5 x 30) mm glass cartridge fuse; 120 V	○ gray	281-622/281-418	50		
	for 1/4" x 1" glass cartridge fuse; 230 V	○ gray	281-613/281-417	50	10 x 60 x 60 mm / 0.39 x 2.36 x 2.36 inch	800 V/8 kV/3 ④; I <sub>n</sub> 10 A; 220 V, 10 A ⑤; 100 V, 10 A ⑥
	for 1/4" x 1" glass cartridge fuse; 120 V	○ gray	281-613/281-418	50		
	for 1/4" x 1 1/4" glass cartridge fuse; 230 V	○ gray	281-623/281-417	50		
for 1/4" x 1 1/4" glass cartridge fuse; 120 V	○ gray	281-623/281-418	50			
	2-conductor disconnect terminal block	○ gray	281-624	100	8 x 60 x 60 mm / 0.32 x 2.36 x 2.36 inch	800 V/8 kV/3 ④; I <sub>n</sub> 16 A; 600 V, 16 A ⑤
		● orange	281-672	100		
	End and intermediate plate	● orange	281-309	25	2,5 x 55,3 x 60 mm / 0.1 x 2.18 x 2.36 inch	
		○ gray	281-311	25		
<b>Fuse terminal block for mini-automotive blade-style fuses ②</b>						
	2-conductor fuse terminal block for automotive blade-style fuses; 12 V; with test point; with blown fuse indication by LED; LED power consumption: 4.8 mA					
	12 V; Circuit 1 ①	○ gray	282-698/281-429	25		
	12 V; Circuit 2 ②	○ gray	282-698/281-449	25	8 x 33,5 x 85 mm / 0.32 x 1.32 x 3.35 inch	400 V/6 kV/3 ④; I <sub>n</sub> 25 A; 30 A ⑤; 30 A ⑥
	24 V; Circuit 1 ①	○ gray	282-698/281-413	25		
24 V; Circuit 2 ②	○ gray	282-698/281-434	25			
	2-conductor fuse terminal block for automotive blade-style fuses; with test point; without blown fuse indication;	○ gray	282-696	25		400 V/6 kV/3 ④; I <sub>n</sub> 25 A; 600 V, 30 A ⑤; 24 V, 30 A ⑥
	End and intermediate plate	● orange	282-334	25	2 x 26,1 x 80,5 mm / 0.08 x 1.03 x 3.33 inch	
		○ gray	282-333	25		

① Conductor range: 0.08 ... 4 mm<sup>2</sup>; 28 ... 12 AWG;  
Strip length: 9 ... 10 mm / 0.35 ... 0.39 inch

② Conductor range: 0.2 ... 6 mm<sup>2</sup>; 24 ... 10 AWG;  
Strip length: 12 ... 13 mm / 0.47 ... 0.51 inch

③ Conductor range: 2.5 ... 16 mm<sup>2</sup>; 14 ... 6 AWG;  
Strip length: 12 ... 13 mm / 0.47 ... 0.51 inch

Accessories: see page 96









Marking: WMB/WMB Inline/Marking strips

④ 400/800 V = rated voltage  
6 kV = rated impulse voltage  
3 = pollution degree

Suitable operating tool: see page 279



## WAGO Fuse Terminal Block; Fuse Plug 4/16 mm<sup>2</sup>; 281/811 Series

Image	Description	Color	Item No.	PU	Dimensions (W x H x D)	Electrical Data
<b>Fuse plug on carrier terminal block</b>						
	Fuse plug with pull-tab	○ gray				
	for (5 x 20) mm and (5 x 25) mm glass cartridge fuses	○ gray	281-511	50		
	for (5 x 20) mm and (5 x 25) mm glass cartridge fuses; with hole for one LED (for self-assembly)	○ gray	281-512	50		
	for (5 x 20) mm and (5 x 25) mm glass cartridge fuses; with LED, 24 VAC/DC	○ gray	281-512/281-501	50	Width: 6 mm / 0.24 inch	250 V; 6,3 A
	for (5 x 20) mm and (5 x 25) mm glass cartridge fuses; with 120 VAC/DC neon lamp	○ gray	281-512/281-418	50		
for (5 x 20) mm and (5 x 25) mm glass cartridge fuses; with 230 VAC/DC neon lamp	○ gray	281-512/281-417	50			
	2-conductor carrier terminal block; 0.08 ... 4 mm <sup>2</sup> / 28 ... 12 inch	○ gray	281-916	50	6 x 29 x 59 mm / 0.24 x 1.14 x 2.32 inch	400 V/6 kV/3 ④; I <sub>N</sub> 10 A
	End and intermediate plate; 2.5 mm thick	● orange	281-329	25	2,5 x 29 x 58,6 mm / 0.1 x 1.14 x 2.31 inch	
		○ gray	281-328	25		
	4-conductor carrier terminal block; 0.08 ... 4 mm <sup>2</sup> / 28 ... 12 inch	○ gray	281-656	50	6 x 29 x 86 mm / 0.24 x 1.14 x 3.39 inch	400 V/6 kV/3 ④; I <sub>N</sub> 10 A
	End and intermediate plate; 2.5 mm thick	● orange	281-335	25	2,5 x 29 x 86,2 mm / 0.1 x 1.14 x 3.4 inch	
		○ gray	281-334	25		
<b>Fuse terminal block for (10 x 38) mm (1 3/32" x 1 1/2") cylindrical fuses ③</b>						
	for photovoltaic applications; without blown fuse indication; 1-pole	○ gray	811-316	12	17,5 x 55 x 105 mm / 0.69 x 2.16 x 4.13 inch	1000 VDC; 32 A
	for photovoltaic applications; with blown fuse indication; 230 ... 1000 VDC; 1-pole	○ gray	811-317	12		
	without blown fuse indication; 1-pole	○ gray	811-310	12		
	without blown fuse indication; 2-pole	○ gray	811-320	6		690 VAC / 1000 VDC; 32 A ⑤; 600 VAC, 30 A ⑥; 750 VAC, 30 A ⑦; 1000 VDC, 30 A ⑧⑨
	without blown fuse indication; 3-pole	○ gray	811-330	4		
	with blown fuse indication; 90 ... 600 VAC; 115 ... 600 VDC; 1-pole	○ gray	811-311	12		
	with blown fuse indication; 90 ... 600 VAC; 115 ... 600 VDC; 2-pole	○ gray	811-321	6		
	with blown fuse indication; 90 ... 600 VAC; 115 ... 600 VDC; 3-pole	○ gray	811-331	4		
	with blown fuse indication; 24 VDC; 1-pole	○ gray	811-314	12		
<b>Fuse terminal block for class CC fuses ④</b>						
	without blown fuse indication; 1-pole	○ gray	811-410	12	17,5 x 55 x 105 mm / 0.69 x 2.16 x 4.13 inch	I <sub>N</sub> 32 A; 600 V, 30 A ⑤; 600 V, 30 A ⑥
	without blown fuse indication; 2-pole	○ gray	811-420	6		
	without blown fuse indication; 3-pole	○ gray	811-430	4		
	with blown fuse indication; 90 ... 600 VAC; 115 ... 600 VDC; 1-pole	○ gray	811-411	12		
	with blown fuse indication; 90 ... 600 VAC; 115 ... 600 VDC; 2-pole	○ gray	811-421	6		
	with blown fuse indication; 90 ... 600 VAC; 115 ... 600 VDC; 3-pole	○ gray	811-431	4		
	with blown fuse indication; 24 VDC; 1-pole	○ gray	811-414	12		
	<b>Accessories for 811 Series</b>					
	Push-in type jumper bar; insulated; I <sub>N</sub> 63 A					
	2-way	gray	811-472	10		
	12-way	gray	811-482	10		

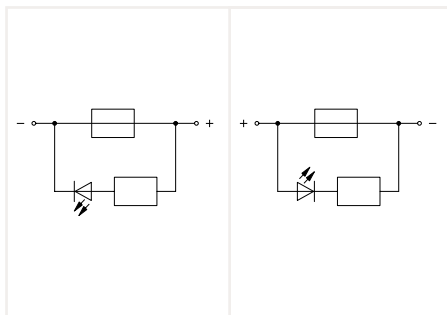

① Circuit 1

② Circuit 2

# WAGO Sensor terminal block











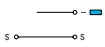
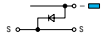

## 2.5 mm<sup>2</sup>; 280 Series

1

Image	Circuit Diagram	Description	Color	Item No.	PU	Dimensions (W x H x D)	Electrical Data
		Sensor terminal block	○ gray	280-560	50	5 x 55,5 x 80 mm / 0.2 x 2.19 x 3.15 inch	400 V/6 kV/3 ①; I <sub>N</sub> 20 A; 300 V, 15 A ②; 300 V, 15 A ③
		Sensor LED terminal block; for PNP (high-side) switching sensors; red LED; LED power consumption: 4.8 mA	○ gray	280-560/281-434	50		24 VDC; I <sub>N</sub> 20 A; 24 V, 15 A ②; 300 V, 15 A ③
		Sensor supply terminal block; power supply from sensor side	○ gray	280-564	10		400 V/6 kV/3 ①; I <sub>N</sub> 20 A; 300 V, 15 A ②; 300 V, 15 A ③
		Sensor LED supply terminal block; power supply from sensor side; for PNP (high-side) switching sensors; green LED; LED power consumption: 4.8 mA	○ gray	280-564/281-483	10		24 VDC; I <sub>N</sub> 20 A; 24 V, 15 A ②; 300 V, 15 A ③
		End and intermediate plate; 1 mm thick	● orange ○ gray	280-321 280-319	25 25	1 x 55,5 x 80 mm / 0.04 x 2.19 x 3.15 inch	
		Sensor terminal block; with ground connection	○ gray	280-570	50	5 x 63,5 x 90,5 mm / 0.2 x 2.5 x 3.56 inch	400 V/6 kV/3 ①; I <sub>N</sub> 20 A; 300 V, 15 A ②; 300 V, 15 A ③
		Sensor LED terminal block; for PNP (high-side) switching sensors; red LED; LED power consumption: 4.8 mA	○ gray	280-570/281-434	50		24 VDC; I <sub>N</sub> 20 A; 24 V, 15 A ②; 300 V, 15 A ③
		Sensor supply terminal block; with ground connection; power supply from sensor side	○ gray	280-574	10		400 V/6 kV/3 ①; I <sub>N</sub> 20 A; 300 V, 15 A ②; 300 V, 15 A ③
		Sensor LED supply terminal block; power supply from sensor side; for PNP (high-side) switching sensors; green LED; LED power consumption: 4.8 mA	○ gray	280-574/281-483	10		24 VDC; I <sub>N</sub> 20 A; 24 V, 15 A ②; 300 V, 15 A ③
		Sensor terminal block	○ gray	280-580	50	5 x 63,5 x 90,5 mm / 0.2 x 2.5 x 3.56 inch	400 V/6 kV/3 ①; I <sub>N</sub> 20 A; 300 V, 15 A ②; 300 V, 15 A ③
		Sensor LED terminal block; for PNP (high-side) switching sensors; red LED; LED power consumption: 4.8 mA	○ gray	280-580/281-434	50		24 VDC; I <sub>N</sub> 20 A; 24 V, 15 A ②;
		Sensor supply terminal block; power supply from sensor side	○ gray	280-584	10		400 V/6 kV/3 ①; I <sub>N</sub> 20 A; 300 V, 15 A ②; 300 V, 15 A ③
		Sensor LED supply terminal block; power supply from sensor side; for PNP (high-side) switching sensors; green LED; LED power consumption: 4.8 mA	○ gray	280-584/281-483	10		24 VDC; I <sub>N</sub> 20 A; 24 V, 15 A ②; 300 V, 15 A ③
		End and intermediate plate; 1 mm thick	● orange ○ gray	280-323 280-320	25 25	1 x 63,5 x 90 mm / 0.04 x 2.5 x 3.54 inch	
<b>Accessories for sensor/actuator terminal blocks</b>							
		Adjacent jumper; insulated; I <sub>N</sub> = I <sub>N</sub> terminal block	○ gray	280-402	25		
		Insulation stop; 5 pcs/strip					
		0.08 ... 0.2 mm <sup>2</sup> "s" (0.14 mm <sup>2</sup> "f-st")	white	280-470	25		
		0.25 ... 0.5 mm <sup>2</sup>	light gray	280-471	25		
		0.75 ... 1 mm <sup>2</sup>	dark gray	280-472	25		

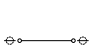
## WAGO Actuator terminal block

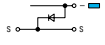
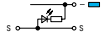
### 2.5 mm<sup>2</sup>; 280 Series

Image	Circuit Diagram	Description	Color	Item No.	PU	Dimensions (W x H x D)	Electrical Data	
		Actuator terminal block	○ gray	280-562	50	5 x 55,5 x 80 mm / 0.2 x 2.19 x 3.15 inch	400 V/6 kV/3 ①; I <sub>N</sub> 20 A; 300 V, 15 A ②; 300 V, 15 A ③	
		Actuator terminal block; with 1N4007 recovery diode	○ gray	280-562/281-411	50		400 V/6 kV/3 ①; I <sub>N</sub> 20 A; 300 V, 15 A ②; 300 V, 15 A ③	
		Actuator LED terminal block; red LED; LED power consumption: 4.8 mA	○ gray	280-562/281-434	50		24 VDC; I <sub>N</sub> 20 A; 24 V, 15 A ②; 300 V, 15 A ③	
		Actuator LED terminal block; with 1N4007 recovery diode; red LED; LED power consumption: 4.8 mA	○ gray	280-562/281-420	50		24 VDC; I <sub>N</sub> 20 A; 24 V, 15 A ②; 300 V, 15 A ③	
		Actuator supply terminal block; power supply from actuator side	○ gray	280-592	10		400 V/6 kV/3 ①; I <sub>N</sub> 20 A; 300 V, 15 A ②; 300 V, 15 A ③	
		Actuator terminal block	○ gray	280-555	50		400 V/6 kV/3 ①; I <sub>N</sub> 20 A; 300 V, 15 A ②; 300 V, 15 A ③	
		Actuator supply terminal block; with 280-555: power supply from control side; with 280-554: power supply from actuator side	○ gray	280-556	20		400 V/6 kV/3 ①; I <sub>N</sub> 20 A; 300 V, 15 A ②; 300 V, 15 A ③	
		Actuator terminal block; with shield connection	○ gray	280-585	50		5 x 63,5 x 90,5 mm / 0.2 x 2.5 x 3.56 inch	400 V/6 kV/3 ①; I <sub>N</sub> 20 A; 300 V, 15 A ②; 300 V, 15 A ③
		Actuator supply terminal block; with shield connection; power supply from control panel side	○ gray	280-586	50			400 V/6 kV/3 ①; I <sub>N</sub> 20 A; 300 V, 15 A ②; 300 V, 15 A ③
		End and intermediate plate; 1 mm thick	● orange ○ gray	280-321 280-319	25 25		1 x 55,5 x 80 mm / 0.04 x 2.19 x 3.15 inch	
		Actuator terminal block; with ground connection	○ gray	280-572	50	5 x 63,5 x 90,5 mm / 0.2 x 2.5 x 3.56 inch	400 V/6 kV/3 ①; I <sub>N</sub> 20 A; 300 V, 15 A ②; 300 V, 15 A ③	
		Actuator terminal block; with ground connection; with 1N4007 recovery diode	○ gray	280-572/281-411	50		400 V/6 kV/3 ①; I <sub>N</sub> 20 A; 300 V, 15 A ②; 300 V, 15 A ③	
		Actuator LED terminal block; with ground connection; red LED; LED power consumption: 4.8 mA	○ gray	280-572/281-434	50		24 VDC; I <sub>N</sub> 20 A; 24 V, 15 A ②; 300 V, 15 A ③	
		Actuator LED terminal block; with ground connection; with 1N4007 recovery diode; red LED; LED power consumption: 4.8 mA	○ gray	280-572/281-420	50		24 VDC; I <sub>N</sub> 20 A; 24 V, 15 A ②; 300 V, 15 A ③	
		Actuator supply terminal block; with ground connection; power supply from actuator side	○ gray	280-593	10		400 V/6 kV/3 ①; I <sub>N</sub> 20 A; 300 V, 15 A ②; 300 V, 15 A ③	
		End and intermediate plate; 1 mm thick	● orange ○ gray	280-323 280-320	25 25		1 x 63,5 x 90 mm / 0.04 x 2.5 x 3.54 inch	

Conductor range: 0.08 ... 2.5 mm<sup>2</sup>; 28 ... 12 AWG;  
Strip length: 8 ... 9 mm / 0.31 ... 0.35 inch

① 400 V = rated voltage  
6 kV = rated impulse voltage  
3 = pollution degree

Accessories: see page 96  
Marking: WMB/WMB Inline/Marking strips  
Suitable operating tool: see page 279

# WAGO X-COM®-SYSTEM

## Operation

1

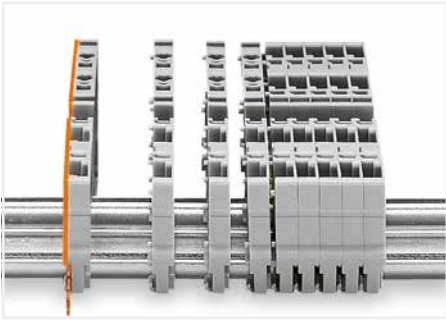

Snap individual carrier terminal blocks onto the DIN-rail and slide together.



Open the assembly by laterally sliding a block via operating tool and remove terminal block via release lever.



Carrier terminal block: Insert/remove conductor via operating tool (3.5 x 0.5 mm blade).



Coding a female plug by removing coding finger(s) via cutting tool. Do not remove the first and last coding fingers or use an additional locking lever.

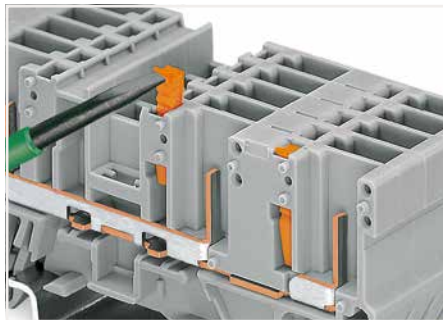

Snap coding pin in proper direction on carrier terminal block. Shown: Coding pin removal from carrier terminal block.

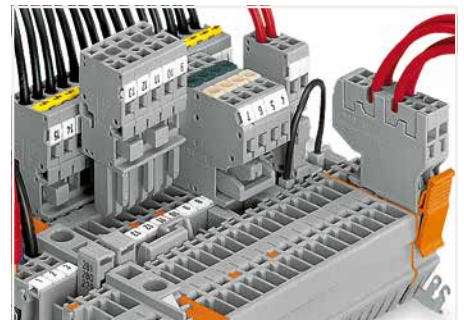

Commoning with adjacent or staggered jumpers – push jumpers down until fully inserted.



Commoning carrier terminal blocks via staggered jumpers.

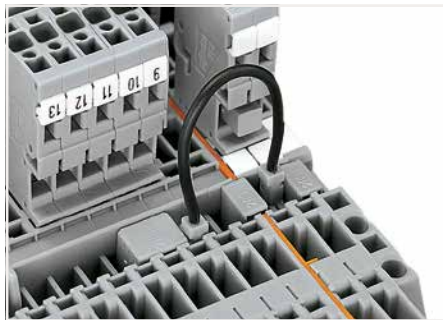

Commoning carrier terminal blocks via push-in type wire jumpers or adjacent jumpers – even over an intermediate plate.

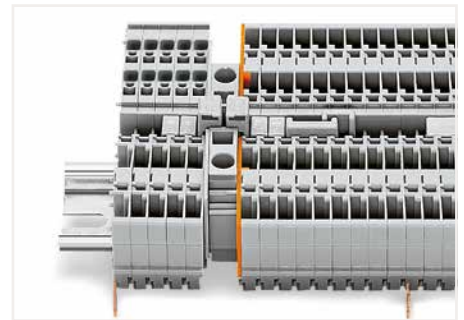

Commoning "supply terminal blocks" (up to 10 mm²/8 AWG) with carrier terminal blocks via step-down jumpers.

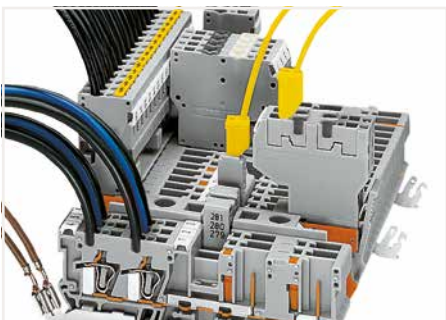

Testing with a 2.3 mm Ø test plug (max. 42 V).













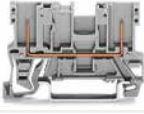

Removing a female plug via conductor bundle provided with strain relief plate.



Commoning a 1-conductor female plug via miniature adjacent jumpers.

# WAGO Carrier Terminal Block; X-COM®-SYSTEM – 769 Series

## 4 mm<sup>2</sup>

Image	Description	Color	Item No.	PU	Dimensions (W x H x D)	Electrical Data
<b>1-conductor/1-pin carrier terminal block</b>						
	1-conductor/1-pin carrier terminal block	○ gray	769-176	100	5 x 28,5 x 52,5 mm / 0.2 x 1.12 x 2.07 inch	500 V/6 kV/3 ①; I <sub>n</sub> 32 A; 300 V, 20 A ②; 300 V, 20 A ③
	1-conductor/1-pin carrier terminal block	● blue	769-176/000-006	100		
	1-conductor/1-pin carrier terminal block	● orange	769-176/000-012	100		
	1-conductor/1-pin ground carrier terminal block	● green-yellow	769-237	100		
	1-conductor/1-pin carrier terminal block; with shield contact	○ gray	769-231	50		
	End and intermediate plate; 1.1 mm thick	● orange	769-308	25	1,1 x 24,1 x 52,5 mm /	
		○ gray	769-307	25	0.04 x 0.95 x 2.07 inch	
<b>2-pin carrier terminal block</b>						
	2-pin carrier terminal block	○ gray	769-156	100	5 x 28,5 x 52,5 mm / 0.2 x 1.12 x 2.07 inch	500 V/6 kV/3 ①; I <sub>n</sub> 32 A; 300 V, 20 A ②; 300 V, 20 A ③
	2-pin ground carrier terminal block	● green-yellow	769-227	100		
	2-pin carrier terminal block; with shield contact	○ gray	769-221	50		
	End and intermediate plate; 1.1 mm thick	● orange	769-306	25	1,1 x 24,1 x 52,5 mm /	
		○ gray	769-305	25	0.04 x 0.95 x 2.07 inch	
<b>2-conductor/2-pin carrier terminal block</b>						
	2-conductor/2-pin carrier terminal block	○ gray	769-171	50	5 x 28,5 x 87,5 mm / 0.2 x 1.12 x 3.44 inch	500 V/6 kV/3 ①; I <sub>n</sub> 32 A; 300 V, 20 A ②; 300 V, 20 A ③
	2-conductor/2-pin carrier terminal block	● blue	769-171/000-006	50		
	2-conductor/2-pin ground carrier terminal block	● green-yellow	769-217	50		
	2-conductor/2-pin carrier terminal block; with shield contact	○ gray	769-211	50		
	End and intermediate plate; 1.1 mm thick	● orange	769-304	25	1,1 x 24,1 x 87,2 mm /	
		○ gray	769-303	25	0.04 x 0.95 x 3.43 inch	
<b>4-pin carrier terminal block</b>						
	4-pin carrier terminal block	○ gray	769-151	50	5 x 28,5 x 87,5 mm / 0.2 x 1.12 x 3.44 inch	500 V/6 kV/3 ①; I <sub>n</sub> 32 A; 300 V, 20 A ②; 300 V, 20 A ③
	4-pin ground carrier terminal block	● green-yellow	769-207	50		
	4-pin carrier terminal block; with shield contact	○ gray	769-201	50		
	End and intermediate plate; 1.1 mm thick	● orange	769-302	25	1,1 x 24,1 x 87,2 mm /	
		○ gray	769-301	25	0.04 x 0.95 x 3.43 inch	
<b>2-conductor/1-pin carrier terminal block</b>						
	2-conductor/1-pin carrier terminal block	○ gray	769-251	50	5 x 28,5 x 69 mm / 0.2 x 1.12 x 2.72 inch	500 V/6 kV/3 ①; I <sub>n</sub> 32 A; 300 V, 20 A ②; 300 V, 20 A ③
	2-conductor/1-pin carrier terminal block	● blue	769-251/000-006	50		
	2-conductor/1-pin ground carrier terminal block	● green-yellow	769-257	50		
	End and intermediate plate; 1.1 mm thick	● orange	769-321	25	1,1 x 24,1 x 69 mm /	
		○ gray	769-320	25	0.04 x 0.95 x 2.72 inch	
<b>1-conductor/1-pin carrier terminal block; with three jumper positions</b>						
	1-conductor/1-pin carrier terminal block; with three jumper positions	○ gray	769-214	50	5 x 28,5 x 87,5 mm / 0.2 x 1.12 x 3.44 inch	500 V/6 kV/3 ①; I <sub>n</sub> 32 A; 300 V, 20 A ②; 300 V, 20 A ③
	End and intermediate plate; 1.1 mm thick	● orange	769-316	25		
		○ gray	769-315	25	0.04 x 0.95 x 3.43 inch	

Conductor range: 0.08 ... 4 mm<sup>2</sup>; 28 ... 12 AWG;  
Strip length: 8 ... 9 mm / 0.31 ... 0.35 inch

① 500 V = rated voltage  
6 kV = rated impulse voltage  
3 = pollution degree

Accessories: see page 96.

Marking: WMB/WMB Inline/Marking strips

Suitable operating tool: see page 279.

# WAGO Disconnect Carrier Terminal Block; X-COM®-SYSTEM – 769 Series

## 4 mm<sup>2</sup>

1

Image	Description	Color	Item No.	PU	Dimensions (W x H x D)	Electrical Data
<b>1-conductor/1-pin disconnect carrier terminal block</b>						
	1-conductor/1-pin disconnect carrier terminal block	○ gray	769-232	50	5 x 28,5 x 52,5 mm / 0.2 x 1.12 x 2.07 inch	400 V/6 kV/3 ①; I <sub>N</sub> 16 A; 300 V, 20 A ②; 300 V, 20 A ③
	1-conductor/1-pin disconnect carrier terminal block; with shield contact	○ gray	769-233	50		
	End and intermediate plate; 1.1 mm thick	● orange	769-308	25	1,1 x 24,1 x 52,5 mm / 0.04 x 0.95 x 2.07 inch	
		○ gray	769-307	25		
<b>2-pin disconnect carrier terminal block</b>						
	2-pin disconnect carrier terminal block	○ gray	769-222	50	5 x 28,5 x 52,5 mm / 0.2 x 1.12 x 2.07 inch	400 V/6 kV/3 ①; I <sub>N</sub> 16 A; 300 V, 20 A ②; 300 V, 20 A ③
	2-pin disconnect carrier terminal block; with shield contact	○ gray	769-223	50		
	End and intermediate plate; 1.1 mm thick	● orange	769-306	25	1,1 x 24,1 x 52,5 mm / 0.04 x 0.95 x 2.07 inch	
		○ gray	769-305	25		
<b>1-conductor/1-pin disconnect carrier terminal block; with two jumper positions</b>						
	1-conductor/1-pin disconnect carrier terminal block; with two jumper positions	○ gray	769-212	50	5 x 28,5 x 87,5 mm / 0.2 x 1.12 x 3.44 inch	400 V/6 kV/3 ①; I <sub>N</sub> 16 A; 300 V, 20 A ②; 300 V, 20 A ③
	1-conductor/1-pin disconnect carrier terminal block; with shield contact; with two jumper positions	○ gray	769-213	50		
	End and intermediate plate; 1.1 mm thick	● orange	769-312	25	1,1 x 24,1 x 87,2 mm / 0.04 x 0.95 x 3.43 inch	
		○ gray	769-311	25		
<b>2-pin disconnect carrier terminal block; with two jumper positions</b>						
	2-pin disconnect carrier terminal block; with two jumper positions	○ gray	769-202	50	5 x 28,5 x 87,5 mm / 0.2 x 1.12 x 3.44 inch	400 V/6 kV/3 ①; I <sub>N</sub> 16 A; 300 V, 20 A ②; 300 V, 20 A ③
	2-pin disconnect carrier terminal block; with shield contact; with two jumper positions	○ gray	769-203	50		
	End and intermediate plate; 1.1 mm thick	● orange	769-310	25	1,1 x 24,1 x 87,2 mm / 0.04 x 0.95 x 3.43 inch	
		○ gray	769-309	25		



**1-conductor female plug**  
Disconnect carrier terminal blocks can be commoned via 280 and 780 Series Jumpers and tested using a test plug adapter (280-4..).



**2-conductor female plug**  
Diode carrier terminal blocks can be commoned via 280 and 780 Series Jumpers and tested using a test plug adapter (280-4..).

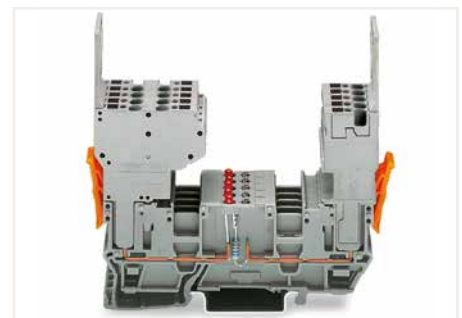













**2-conductor and 1-conductor female plugs (may be reversed)**  
LED carrier terminal blocks can be commoned via 280 and 780 Series Jumpers and tested using a test plug adapter (280-4..).

Conductor range: 0.08 ... 4 mm<sup>2</sup>; 28 ... 12 AWG;  
Strip length: 8 ... 9 mm / 0.31 ... 0.35 inch

① 400 V = rated voltage  
6 kV = rated impulse voltage  
3 = pollution degree

Accessories: see page 96.  
Marking: WMB/WMB Inline/Marking strips  
Suitable operating tool: see page 279.

# WAGO Diode Carrier Terminal Block; LED Carrier Terminal Block; X-COM®-SYSTEM – 769 Series 4 mm<sup>2</sup>

Image	Description	Color	Item No.	PU	Dimensions (W x H x D)	Electrical Data
<b>1-conductor/1-pin diode/LED carrier terminal block</b>						
	1-conductor/1-pin diode carrier terminal block; right-side anode	○ gray	769-238/281-411	100	5 x 28,5 x 52,5 mm / 0.2 x 1.12 x 2.07 inch	U <sub>N</sub> 250 V; U <sub>RM</sub> 1000 V; 1N4007 – 0.5 A continuous current
	1-conductor/1-pin diode carrier terminal block; left-side anode	○ gray	769-238/281-410	100		
	1-conductor/1-pin LED carrier terminal block; right-side anode	○ gray	769-239/281-413	100	5 x 28,5 x 52,5 mm / 0.2 x 1.12 x 2.07 inch	24 VDC; I <sub>F</sub> 0.025 A (max.)
	1-conductor/1-pin LED carrier terminal block; left-side anode	○ gray	769-239/281-434	100		
	End and intermediate plate; 1.1 mm thick	● orange	769-308	25	1,1 x 24,1 x 52,5 mm / 0.04 x 0.95 x 2.07 inch	
		○ gray	769-307	25		
<b>2-pin diode/LED carrier terminal block</b>						
	2-pin diode carrier terminal block; right-side anode	○ gray	769-228/281-411	100	5 x 28,5 x 52,5 mm / 0.2 x 1.12 x 2.07 inch	U <sub>N</sub> 250 V; U <sub>RM</sub> 1000 V; 1N4007 – 0.5 A continuous current
	2-pin diode carrier terminal block; left-side anode	○ gray	769-228/281-410	100		
	2-pin LED carrier terminal block; right-side anode	○ gray	769-229/281-413	100	5 x 28,5 x 52,5 mm / 0.2 x 1.12 x 2.07 inch	24 VDC; I <sub>F</sub> 0.025 A (max.)
	2-pin LED carrier terminal block; left-side anode	○ gray	769-229/281-434	100		
	End and intermediate plate; 1.1 mm thick	● orange	769-306	25	1,1 x 24,1 x 52,5 mm / 0.04 x 0.95 x 2.07 inch	
		○ gray	769-305	25		
<b>1-conductor/1-pin diode/LED carrier terminal block; with two jumper positions</b>						
	1-conductor/1-pin diode carrier terminal block; with two jumper positions; right-side anode	○ gray	769-218/281-411	50	5 x 28,5 x 87,5 mm / 0.2 x 1.12 x 3.44 inch	U <sub>N</sub> 250 V; U <sub>RM</sub> 1000 V; 1N4007 – 0.5 A continuous current
	1-conductor/1-pin diode carrier terminal block; with two jumper positions; right-side anode	○ gray	769-218/281-410	50		
	1-conductor/1-pin LED carrier terminal block; with two jumper positions; right-side anode	○ gray	769-219/281-413	50	5 x 28,5 x 87,5 mm / 0.2 x 1.12 x 3.44 inch	24 VDC; I <sub>F</sub> 0.025 A (max.)
	1-conductor/1-pin LED carrier terminal block; with two jumper positions; right-side anode	○ gray	769-219/281-434	50		
	End and intermediate plate; 1.1 mm thick	● orange	769-312	25	1,1 x 24,1 x 87,2 mm / 0.04 x 0.95 x 3.43 inch	
		○ gray	769-311	25		
<b>2-pin diode/LED carrier terminal block; with two jumper positions</b>						
	2-pin diode carrier terminal block; with two jumper positions; right-side anode	○ gray	769-208/281-411	50	5 x 28,5 x 87,5 mm / 0.2 x 1.12 x 3.44 inch	U <sub>N</sub> 250 V; U <sub>RM</sub> 1000 V; 1N4007 – 0.5 A continuous current
	2-pin diode carrier terminal block; with two jumper positions; left-side anode	○ gray	769-208/281-410	50		
	2-pin LED carrier terminal block; with two jumper positions; right-side anode	○ gray	769-209/281-413	50	5 x 28,5 x 87,5 mm / 0.2 x 1.12 x 3.44 inch	24 VDC; I <sub>F</sub> 0.025 A (max.)
	2-pin LED carrier terminal block; with two jumper positions; left-side anode	○ gray	769-209/281-434	50		
	End and intermediate plate; 1.1 mm thick	● orange	769-310	25	1,1 x 24,1 x 87,2 mm / 0.04 x 0.95 x 3.43 inch	
		○ gray	769-309	25		

Conductor range: 0.08 ... 4 mm<sup>2</sup>; 28 ... 12 AWG;  
Strip length: 8 ... 9 mm / 0.31 ... 0.35 inch

Accessories: see page 96.  
Suitable operating tool: see page 279.

Marking: WMB/WMB Inline/Marking strips

# WAGO Double-Deck Carrier Terminal Block; X-COM®-SYSTEM – 870 Series

## 2,5 mm<sup>2</sup>

1

Image	Description	Color	Item No.	PU	Potential Marking	Electrical Data
<b>1-conductor/1-pin double-deck carrier terminal block ①</b>						
	1-conductor/1-pin double-deck carrier terminal block; Through/through terminal block	○ gray	<b>870-101</b>	50	L/L	500 V/6 kV/3 ⑤; I <sub>N</sub> 16 A; 300 V, 20 A ⑧
		○ gray	<b>870-102</b>	50	N/L	
		○ gray	<b>870-103</b>	50	L/N	
		● blue	<b>870-104</b>	50	N/N	
	1-conductor/1-pin double-deck carrier terminal block; Ground conductor/through terminal block	○ gray	<b>870-117</b>	50	GND/N	
		○ gray	<b>870-127</b>	50	GND/L	
	End and intermediate plate; 1 mm thick	● orange	<b>870-119</b>	25		
		○ gray	<b>870-118</b>	25		

<b>2-pin/2-pin double-deck carrier terminal block ②</b>							
	2-conductor/1-pin double-deck carrier terminal block; Through/through terminal block	○ gray	<b>870-1131</b>	40	L/L	500 V/6 kV/3 ⑤; I <sub>N</sub> 16 A; 300 V, 20 A ⑧	
	4-conductor/2-pin double-deck carrier block; 4-conductor/2-pin ground conductor block; internally commoned	● green-yellow	<b>870-1137</b>	40	GND/N		
	4-conductor/2-pin carrier terminal block; 2-conductor/2-pin through terminal block; internally commoned; violet conductor entry	○ gray	<b>870-1138</b>	40	L		
	End and intermediate plate; 1 mm thick	● orange	<b>870-1149</b>	25			
		○ gray	<b>870-1148</b>	25			

<b>2-pin/2-pin double-deck carrier terminal block ③</b>							
	2-pin/2-pin double-deck carrier terminal block; Through/through terminal block	○ gray	<b>870-151</b>	50	L/L	500 V/6 kV/3 ⑤; I <sub>N</sub> 16 A	
	4-pin double-deck carrier terminal block; Ground conductor/through terminal block	● green-yellow	<b>870-157</b>	50	GND		
	4-pin double-deck carrier terminal block; 4-pin through terminal block; internally commoned; violet conductor entry	○ gray	<b>870-158</b>	50	L		
	End and intermediate plate; 1 mm thick	● orange	<b>870-169</b>	25			
		○ gray	<b>870-168</b>	25			

<b>2-conductor/2-pin double-deck carrier terminal block ④</b>							
	2-conductor/2-pin double-deck carrier terminal block; Through/through terminal block	○ gray	<b>870-131</b>	40	L/L	500 V/6 kV/3 ⑤; I <sub>N</sub> 16 A	
	4-conductor/4-pin double-deck carrier block; 4-conductor/4-pin ground conductor block; internally commoned	● green-yellow	<b>870-137</b>	40	GND		
	4-conductor/4-pin double-deck carrier terminal block; 4-conductor/4-pin through terminal block; internally commoned; violet conductor entry	○ gray	<b>870-138</b>	40	L		
	End and intermediate plate; 1 mm thick	● orange	<b>870-149</b>	25			
		○ gray	<b>870-148</b>	25			

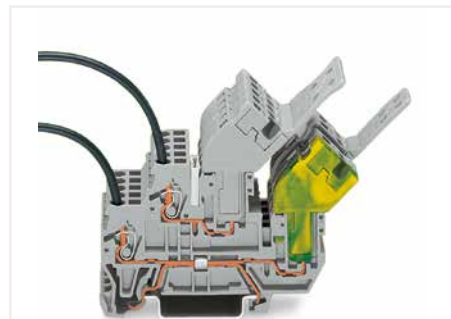

1-conductor female plug; angled  
Double-deck carrier terminal blocks can be commoned via 870 Series Push-In Type Jumper Bars.



1-connector female plug; straight  
Double-deck carrier terminal blocks can be commoned via 870 Series Push-In Type Jumper Bars.

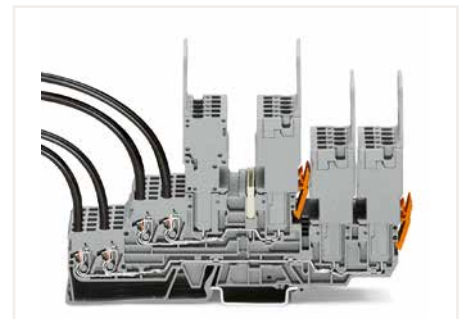

1-connector female plug; straight  
Double-deck carrier terminal blocks can be commoned via 870 Series Push-In Type Jumper Bars.

- ① Dimensions (W x H x D):  
5 x 40 x 70 mm / 0.2 x 1.57 x 2.76 inch;  
Conductor range: 0.08 ... 2.5 mm<sup>2</sup> / 28 ... 16 AWG;  
Strip length: 6 ... 7 mm / 0.24 ... 0.28 inch
- ④ Dimensions (W x H x D):  
5 x 37.1 x 132.7 mm / 0.2 x 1.46 x 5.22 inch;  
Conductor range: 0.08 ... 2.5 mm<sup>2</sup> / 28 ... 12 AWG;  
Strip length: 6 ... 7 mm / 0.24 ... 0.28 inch











- ② Dimensions (W x H x D):  
5 x 39.8 x 91 mm / 0.2 x 1.57 x 3.58 inch;  
Conductor range: 0.08 ... 2.5 mm<sup>2</sup> / 28 ... 12 AWG;  
Strip length: 6 ... 7 mm / 0.24 ... 0.28 inch
- ⑤ 500/500 V = rated voltage;  
6 kV = rated impulse voltage;  
3 = pollution degree

- ③ Dimensions (W x H x D):  
5 x 37.1 x 88.6 mm / 0.2 x 1.46 x 3.49 inch
- Accessories: see page 96.
- Marking: WMB/WMB Inline/Marking strips
- Suitable operating tool: see page 279.



## WAGO Female Plug; X-COM®-SYSTEM – 769 Series

### 4 mm<sup>2</sup>

Image	Description	Color	Item No.	PU	Dimensions (W x H x D)	Electrical Data
<b>1-conductor female plug</b>						
	1-conductor female plug; straight; fits into carrier terminal blocks; codable; can be commoned with miniature adjacent jumpers					
	1-pole	○ gray	769-101	200		
	2-pole	○ gray	769-102	100	(5 x pole no.) x 45.2 x 18.3 mm / (0.2 x pole no.) x 1.78 x 0.72 inch	500 V/6 kV/3 ①; I <sub>n</sub> 32 A; 300 V, 20 A ②; 300 V, 20 A ③
	3-pole	○ gray	769-103	50		
	...		...			
15-pole	○ gray	769-115	10			
	1-conductor female plug; angled; fits into carrier terminal blocks; codable					
	1-pole	○ gray	769-101/022-000	200	(5 x pole no.) x 37.1 x 26.5 mm / (0.2 x pole no.) x 1.46 x 1.04 inch	500 V/6 kV/3 ①; I <sub>n</sub> 32 A; 300 V, 20 A ②; 300 V, 20 A ③
	2-pole	○ gray	769-102/022-000	100		
	3-pole	○ gray	769-103/022-000	50		
	...		...			
15-pole	○ gray	769-115/022-000	10			
<b>2-conductor female plug</b>						
	2-conductor female plug; fits into carrier terminal blocks; codable; can be commoned with adjacent and staggered jumpers					
	1-pole	○ gray	769-121	100	(5 x pole no.) x 45.2 x 35.9 mm / (0.2 x pole no.) x 1.78 x 1.41 inch	500 V/6 kV/3 ①; I <sub>n</sub> 32 A; 300 V, 20 A ②; 300 V, 20 A ③
	2-pole	○ gray	769-122	50		
	3-pole	○ gray	769-123	25		
	...		...			
15-pole	○ gray	769-135	5			
<b>Accessories for female plugs</b>						
	Locking lever; for 1-pole female plugs	○ gray	769-428	25		
	Locking lever; for 1-pole female plugs	● orange	769-429	25		
	Locking lever; for female plugs with 2 poles and more	● orange	769-431	25		
	Locking lever; for female plugs with 2 poles and more	○ gray	769-430	25		
	Strain relief plate; 1-pole	○ gray	769-410	25		
	Strain relief plate; 2- ... 3-pole	○ gray	769-411	25		
	Strain relief plate; 4- ... 5-pole	○ gray	769-412	25		
	Strain relief plate; 6- ... 9-pole	○ gray	769-413	25		
	Strain relief plate; 10- ... 15-pole	○ gray	769-414	25		
	Snap-on type strain relief housing; consists of strain relief support and housing; only suitable for cable ties					
	2-pole	○ gray	769-1602	100		
	...		...			
	Snap-on type strain relief housing; consists of strain relief support and housing					
	2-pole	○ gray	769-1606	100		
	...		...			
	15-pole	○ gray	769-1615	25		
	Coding pin; for coding female plugs	● orange	769-435	25		
	Insulation stop; 5 pcs/strip					
	0.08 ... 0.2 mm <sup>2</sup>	○ white	769-470	25		
	0.25 ... 0.5 mm <sup>2</sup>	○ light gray	769-471	25		
	0.75 ... 1 mm <sup>2</sup>	● dark gray	769-472	25		

Conductor range: 0.08 ... 2.5 mm<sup>2</sup>; 28 ... 12 AWG;  
Strip length: 8 ... 9 mm / 0.31 ... 0.35 inch

① 500 V = rated voltage  
6 kV = rated impulse voltage  
3 = pollution degree

Accessories: see page 96.  
Marking: WMB/WMB Inline/Marking strips  
Suitable operating tool: see page 279.

# Series-Specific Accessories for WAGO Classic Rail-Mount Terminal Block and X-COM® Selection Guide

1

Illustration	Description	279 Series	PU	280 Series 769 Series	PU	281 Series	PU	282 Series	PU	284 Series	PU	283 Series	PU
	Adjacent jumper; insulated; I <sub>N</sub> = I <sub>N</sub> terminal block	<input type="radio"/> 279-402	25	<input type="radio"/> 280-402	25	<input type="radio"/> 281-402	25	<input type="radio"/> 282-402	25	<input type="radio"/> 284-402	25	<input type="radio"/> 283-402	25
		<input checked="" type="radio"/> 279-422	25	<input checked="" type="radio"/> 280-422	25	<input checked="" type="radio"/> 281-422	25	<input checked="" type="radio"/> 282-422	25	<input checked="" type="radio"/> 284-422	25	<input checked="" type="radio"/> 283-422	25
	Double adjust jumper; insulated; I <sub>N</sub> = I <sub>N</sub> of terminal block	<input type="radio"/> 279-409	25	<input type="radio"/> 280-409	25	<input type="radio"/> 281-409	25	<input type="radio"/> 282-409	25	<input type="radio"/> 284-409	25	<input type="radio"/> 283-409	25
	Staggered jumper; I <sub>N</sub> = I <sub>N</sub> of terminal block												
	1 to 2			<input type="radio"/> 780-452	25	<input type="radio"/> 781-452	25						
	1 to 3			<input type="radio"/> 780-453	25	<input type="radio"/> 781-453	25						
	1 to 4			<input type="radio"/> 780-454	25	<input type="radio"/> 781-454	25						
	1 to 5			<input type="radio"/> 780-455	25	<input type="radio"/> 781-455	25						
	1 to 6			<input type="radio"/> 780-456	25	<input type="radio"/> 781-456	25						
	1 to 7			<input type="radio"/> 780-457	25								
	1 to 8			<input type="radio"/> 780-458	25								
	Vertical jumper			<input type="radio"/> 281-421	25	<input type="radio"/> 281-421	25						
	Comb-style jumper bar; insulated; I <sub>N</sub> = I <sub>N</sub> of terminal block												
	2-way	<input type="radio"/> 279-482	25	<input type="radio"/> 280-482	25	<input type="radio"/> 281-482	25						
	3-way	<input type="radio"/> 279-483	25	<input type="radio"/> 280-483	25	<input type="radio"/> 281-483	25						
	5-way					<input type="radio"/> 281-485	25						
	10-way	<input type="radio"/> 279-490	25	<input type="radio"/> 280-490	25	<input type="radio"/> 281-490	25						
	Alternate comb-style jumper bar; insulated; I <sub>N</sub> = I <sub>N</sub> of terminal block	<input type="radio"/> 279-492	25	<input type="radio"/> 280-492	25	<input type="radio"/> 281-492	25						
	Push-in type wire jumper; I <sub>N</sub> 30 A												
	L = 60 mm	<input checked="" type="radio"/> 249-125	10	<input checked="" type="radio"/> 249-125	10	<input checked="" type="radio"/> 249-125	10						
	L = 110 mm	<input checked="" type="radio"/> 249-126	10	<input checked="" type="radio"/> 249-126	10	<input checked="" type="radio"/> 249-126	10						
	L = 250 mm	<input checked="" type="radio"/> 249-127	10	<input checked="" type="radio"/> 249-127	10	<input checked="" type="radio"/> 249-127	10						
	Insulation stop	<input type="radio"/> 279-470	25	<input type="radio"/> 280-470	25	<input type="radio"/> 281-470	25						
		<input checked="" type="radio"/> 279-471	25	<input type="radio"/> 280-471	25	<input type="radio"/> 281-471	25						
				<input checked="" type="radio"/> 280-472	25	<input checked="" type="radio"/> 281-472	25						
	Protective warning marker	<input checked="" type="radio"/> 279-415	25	<input checked="" type="radio"/> 280-415	25	<input checked="" type="radio"/> 281-415	25	<input checked="" type="radio"/> 281-415	25	<input checked="" type="radio"/> 284-415	25	<input checked="" type="radio"/> 283-415	25
	Finger guard									<input checked="" type="radio"/> 284-400	25	<input checked="" type="radio"/> 283-400	25
	Test plug module			<input type="radio"/> 280-418	25	<input type="radio"/> 281-418	25	<input type="radio"/> 709-310	25	<input type="radio"/> 709-310	25		
	Spacer module			<input type="radio"/> 280-419	25	<input type="radio"/> 281-419	25	<input type="radio"/> 709-311	25				
	Test plug adapter												
	2.3 mm	<input type="radio"/> 280-404	25	<input type="radio"/> 280-404	25	<input type="radio"/> 280-404	25						
	4 mm	<input type="radio"/> 209-170	25	<input type="radio"/> 209-170	25	<input type="radio"/> 209-170	25	<input type="radio"/> 209-170	25	<input type="radio"/> 209-170	25	<input type="radio"/> 209-170	25
	Test plug with CAGE CLAMP®			<input type="radio"/> 281-407	25	<input type="radio"/> 281-407	25						

I<sub>N</sub> = I<sub>N</sub> terminal block

## Series-Specific Accessories for WAGO Classic Rail-Mount Terminal Block Handling

1

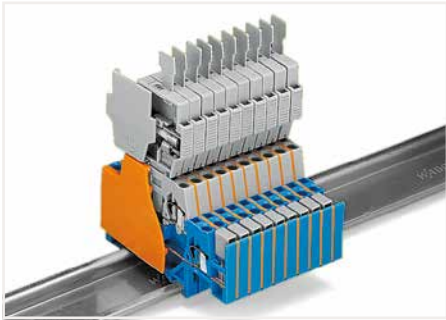

When double-deck terminal blocks are used with a fuse plug (6 mm wide) in the receptacle (top) level, the extra width of the 280 Series (5 mm wide) can be compensated for via intermediate plates (1.1 mm thick). If required, this special intermediate plate still allows commoning on the lower level via push-in adjacent jumpers (280-402).

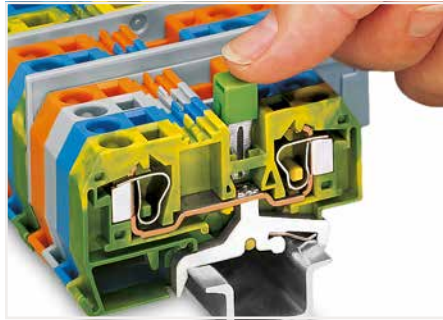

Commoning ground conductor terminal blocks through terminal blocks is possible in one direction only (via rear side of terminal block) using adjacent jumpers. WAGO recommends using yellow-green adjacent jumpers in addition to the required marking of these blocks.



Staggered jumpers are suitable for sophisticated circuit requirements – push jumpers down until fully inserted.

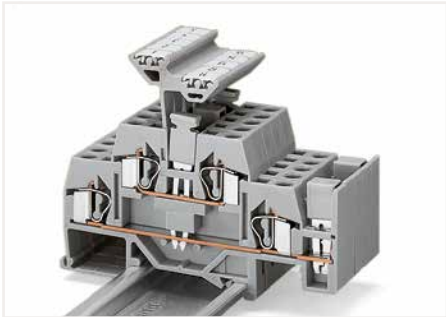

A vertical jumper commons the upper and lower decks, creating a 4-conductor commoned through terminal block in one housing. Two adjacent terminals may be commoned together on the same deck using a push-in adjacent jumper.



Commoning front-entry disconnect terminal blocks via comb-style jumper bar using a 10-pole operating tool

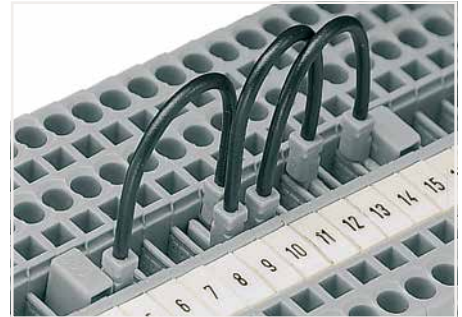

The 280/775/780 and 281/776/777/781 Series Terminal Blocks accept two wire jumpers, allowing the use of commoning chains. Furthermore, the 280/769/775/780/880 and 281/776/777/781 Series allow both a wire jumper and an adjacent jumper to be simultaneously plugged into a same terminal block.

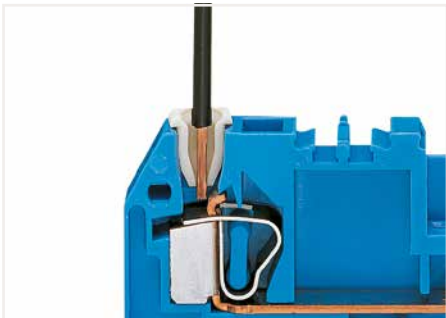

The insulation stop bundles the conductor during connection to the clamping unit.



Protective warning markers inserted into the operating slots



Finger guard seals an unused conductor entry.



Snapping test plug and spacer modules together to assemble a multipole test plug module (max. 10 poles)

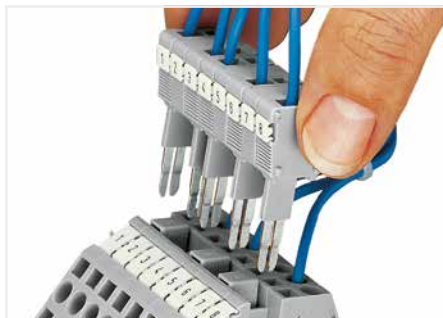

Testing in the jumper slot



Testing with a test plug  
Picture shows a test plug adapter (209-170)

# WAGO Matrix Patchboard; WAGO Common Potential Matrix Patchboard – 726 Series

## 1,5 / 2,5 / 16 mm<sup>2</sup>

1

Image	Description	Color	Item No.	PU	Marking	Electrical Data
<b>Matrix patchboard; 32-pole</b>						
	Matrix patchboard; gray/white modules; vertical module marking on sides 1 and 2; 32-pole	● dark gray	726-121 <b>1</b>	20	1 ... 32	500 V/6 kV/3 <b>4</b> ; I <sub>N</sub> 10 A; 300 V, 10 A <b>5A</b> ; 300 V, 10 A <b>6C</b>
	Matrix patchboard; gray/white modules; vertical module marking on sides 1 and 2; 32-pole	● dark gray	726-122 <b>1</b>	20	33 ... 64	
	Matrix patchboard; gray/white modules; vertical module marking on sides 1 and 2; 32-pole	● dark gray	726-221 <b>2</b>	20	1 ... 32	
	Matrix patchboard; gray/white modules; vertical module marking on sides 1 and 2; 32-pole	● dark gray	726-222 <b>2</b>	20	33 ... 64	
	Matrix patchboard; gray/white modules; vertical module marking on sides 1 and 2; for 19" racks; 32-pole	● dark gray	726-321 <b>1</b>	24	1 ... 32	
	Matrix patchboard; gray/white modules; vertical module marking on sides 1 and 2; for 19" racks; 32-pole	● dark gray	726-322 <b>1</b>	24	33 ... 64	
	Matrix patchboard; blue modules; vertical module marking on sides 1 and 2; 32-pole	● dark gray	726-141 <b>1 5</b>	20	1 ... 32	
Matrix patchboard; blue modules; vertical module marking on sides 1 and 2; 32-pole	● dark gray	726-142 <b>1 5</b>	20	33 ... 64		
Matrix patchboard; blue modules; vertical module marking on sides 1 and 2; 32-pole	● dark gray	726-241 <b>2 5</b>	20	1 ... 32		
Matrix patchboard; blue modules; vertical module marking on sides 1 and 2; 32-pole	● dark gray	726-242 <b>2 5</b>	20	33 ... 64		
Matrix patchboard; blue modules; vertical module marking on sides 1 and 2; for 19" racks; 32-pole	● dark gray	726-341 <b>2 5</b>	24	1 ... 32		
Matrix patchboard; blue modules; vertical module marking on sides 1 and 2; for 19" racks; 32-pole	● dark gray	726-342 <b>2 5</b>	24	33 ... 64		
<b>Matrix patchboard; 48-pole</b>						
	Matrix patchboard; gray/white modules; vertical module marking on sides 1 and 2; 48-pole	● dark gray	726-421 <b>1</b>	10	1 ... 48	500 V/6 kV/3 <b>4</b> ; I <sub>N</sub> 10 A; 300 V, 10 A <b>5A</b> ; 300 V, 10 A <b>6C</b>
	Matrix patchboard; gray/white modules; vertical module marking on sides 1 and 2; 48-pole	● dark gray	726-521 <b>2</b>	10	1 ... 48	
	Matrix patchboard; blue modules; vertical module marking on sides 1 and 2; 48-pole	● dark gray	726-441 <b>1 5</b>	10	1 ... 48	
	Matrix patchboard; blue modules; vertical module marking on sides 1 and 2; 48-pole	● dark gray	726-541 <b>2 5</b>	10	1 ... 48	
<b>Matrix patchboard; 80-pole</b>						
	Matrix patchboard; gray/white modules; vertical module marking on sides 1 and 2; 80-pole	● dark gray	726-721 <b>1</b>	8	1 ... 80	500 V/6 kV/3 <b>4</b> ; I <sub>N</sub> 10 A; 300 V, 10 A <b>5A</b> ; 300 V, 10 A <b>6C</b>
	Matrix patchboard; gray/white modules; vertical module marking on sides 1 and 2; 80-pole	● dark gray	726-821 <b>2</b>	8	1 ... 80	
	Matrix patchboard; blue modules; vertical module marking on sides 1 and 2; 80-pole	● dark gray	726-741 <b>1 5</b>	8	1 ... 80	
	Matrix patchboard; blue modules; vertical module marking on sides 1 and 2; 80-pole	● dark gray	726-841 <b>2 5</b>	8	1 ... 80	
<b>Common potential matrix patchboard; 24-pole</b>						
	Common potential matrix patchboard; gray modules; vertical module marking; with one supply terminal block incl. end plate; for 19" racks; slimline version	● dark gray	726-601 <b>3</b>	10	1 ... 24	Side 1: I <sub>N</sub> 24 A; Side 1: I <sub>N</sub> 76 A
	Common potential matrix patchboard; gray modules; vertical module marking; with two supply terminal blocks incl. end plate; for 19" racks; slimline version	● dark gray	726-602 <b>3</b>	10	1 ... 24	
	Common potential matrix patchboard; white modules; vertical module marking; with one supply terminal block incl. end plate; for 19" racks; slimline version	● dark gray	726-611 <b>3</b>	10	1 ... 24	
	Common potential matrix patchboard; white modules; vertical module marking; with two supply terminal blocks incl. end plate; for 19" racks; slimline version	● dark gray	726-612 <b>3</b>	10	1 ... 24	
	Common potential matrix patchboard; blue modules; vertical module marking; with one supply terminal block incl. end plate; for 19" racks; slimline version	● dark gray	726-631 <b>3 5</b>	10	1 ... 24	
	Common potential matrix patchboard; blue modules; vertical module marking; with two supply terminal blocks incl. end plate; for 19" racks; slimline version	● dark gray	726-632 <b>3 5</b>	10	1 ... 24	
	Common potential matrix patchboard; green-yellow modules; vertical module marking; with one supply terminal block incl. end plate; for 19" racks; slimline version	● dark gray	726-621 <b>3</b>	10	1 ... 24	
	Common potential matrix patchboard; green-yellow modules; vertical module marking; with two supply terminal blocks incl. end plate; for 19" racks; slimline version	● dark gray	726-622 <b>3</b>	10	1 ... 24	

**1** Side 1: 3 x (0.08 ... 1.5 mm<sup>2</sup> / 28 ... 16 AWG);  
Side 2: 3 x (0.08 ... 1.5 mm<sup>2</sup> / 28 ... 16 AWG);  
Strip length: 8 ... 10 mm / 0.31 ... 0.39 inch

**2** Side 1: 3 x (0.08 ... 1.5 mm<sup>2</sup> / 28 ... 16 AWG);  
Side 2: 2 x (0.08 ... 2.5 mm<sup>2</sup> / 28 ... 14 AWG);  
Strip length: 8 ... 10 mm / 0.31 ... 0.39 inch

**3** Side 1: 24 x (2 x 0.08 ... 2.5 mm<sup>2</sup> / 28 ... 14 AWG);  
Strip length: 8 ... 10 mm / 0.31 ... 0.39 inch  
Side 2: 1 x or 2 x (0.5 ... 16 mm<sup>2</sup> / 20 ... 4 AWG);  
Strip length: 18 ... 20 mm / 0.71 ... 0.79 inch











**4** 500 V = rated voltage  
6 kV = rated impulse voltage  
3 = pollution degree

**5** suitable for Ex i applications

Accessories: see page 278.  
Marking: WMB/WMB Inline/Marking strips  
Suitable operating tool: see page 279.

# WAGO Terminal Block for Matrix Patching; WAGO Common Potential Terminal Block – 727 Series

## 1,5 mm<sup>2</sup>

Image	Description	Color	Item No.	PU	Dimensions (W x H x D)	Electrical Data
<b>4-level terminal block for matrix patching</b>						
	4-level terminal block for matrix patching; with locking clips; no marking; 4 x pairs of clamping units on the same level; for DIN 35 x 7.5 rail	○ gray ○ white ● blue	727-219 727-221 727-223 ②	50 50 50	7,62 x 62 x 126 mm / 0.3 x 2.44 x 4.96 inch	250 V/4 kV/3 ①; I <sub>n</sub> 12 A; 300 V, 10 A ②; 300 V, 10 A ③
	4-level terminal block for matrix patching; with locking clips; no marking; 4 x pairs of clamping units on the same level; for DIN 35 x 15 rail	○ gray ○ white ● blue	727-229 727-231 727-233	50 50 50		
	4-level terminal block for matrix patching; without locking clips; no marking; 4 x pairs of clamping units on the same level; for DIN 35 x 7.5 rail	○ gray ○ white ● blue	727-220 727-222 727-224 ②	50 50 50	7,62 x 44,5 x 126 mm / 0.3 x 1.75 x 4.96 inch	
	4-level terminal block for matrix patching; without locking clips; no marking; 4 x pairs of clamping units on the same level; for DIN 35 x 15 rail	○ gray ○ white ● blue	727-230 727-232 727-234	50 50 50		
	4-level terminal block for matrix patching; with locking clips; no marking; all clamping units connected to the same current bar; for DIN 35 x 7.5 rail	● orange ○ light gray	727-225 727-227	50 50	7,62 x 62 x 126 mm / 0.3 x 2.44 x 4.96 inch	250 V/4 kV/3 ①; I <sub>n</sub> 18 A; 300 V, 10 A ②; 300 V, 10 A ③
	4-level terminal block for matrix patching; with locking clips; no marking; all clamping units connected to the same current bar; for DIN 35 x 15 rail	● orange ○ light gray	727-235 727-237	50 50		
	4-level terminal block for matrix patching; without locking clips; no marking; all clamping units connected to the same current bar; for DIN 35 x 7.5 rail	● orange ○ light gray	727-226 727-228	50 50	7,62 x 44,5 x 126 mm / 0.3 x 1.75 x 4.96 inch	
	4-level terminal block for matrix patching; without locking clips; no marking; all clamping units connected to the same current bar; for DIN 35 x 15 rail	● orange ○ light gray	727-236 727-238	50 50		
	4-level end plate; 7.62 mm thick	● orange ○ gray	727-217 727-213	25 25	7,62 x 44,3 x 126 mm / 0.3 x 1.74 x 4.96 inch	
<b>8-level terminal block for matrix patching</b>						
	8-level terminal block for matrix patching; with locking clips; no marking; 8 x pairs of clamping units on the same level; for DIN 35 x 7.5 rail	○ gray ○ white ● blue	727-119 727-121 727-123 ②	25 25 25	7,62 x 76 x 226 mm / 0.3 x 2.99 x 8.9 inch	250 V/4 kV/3 ①; I <sub>n</sub> 12 A; 300 V, 10 A ②; 300 V, 10 A ③
	8-level terminal block for matrix patching; with locking clips; no marking; 8 x pairs of clamping units on the same level; for DIN 35 x 15 rail	○ gray ○ white ● blue	727-129 727-131 727-133	25 25 25		
	8-level terminal block for matrix patching; without locking clips; no marking; 8 x pairs of clamping units on the same level; for DIN 35 x 7.5 rail	○ gray ○ white ● blue	727-120 727-122 727-124 ②	25 25 25	7,62 x 58,5 x 226 mm / 0.3 x 2.3 x 8.9 inch	
	8-level terminal block for matrix patching; without locking clips; no marking; 8 x pairs of clamping units on the same level; for DIN 35 x 15 rail	○ gray ○ white ● blue	727-130 727-132 727-134	25 25 25		
	8-level terminal block for matrix patching; with locking clips; no marking; all clamping units connected to the same current bar; for DIN 35 x 7.5 rail	● orange ○ light gray	727-125 727-127	25 25	7,62 x 76 x 226 mm / 0.3 x 2.99 x 8.9 inch	250 V/4 kV/3 ①; I <sub>n</sub> 18 A; 300 V, 10 A ②; 300 V, 10 A ③
	8-level terminal block for matrix patching; with locking clips; no marking; all clamping units connected to the same current bar; for DIN 35 x 15 rail	● orange ○ light gray	727-135 727-137	25 25		
	8-level terminal block for matrix patching; without locking clips; no marking; all clamping units connected to the same current bar; for DIN 35 x 7.5 rail	● orange ○ light gray	727-126 727-128	25 25	7,62 x 58,5 x 226 mm / 0.3 x 2.3 x 8.9 inch	
	8-level terminal block for matrix patching; without locking clips; no marking; all clamping units connected to the same current bar; for DIN 35 x 15 rail	● orange ○ light gray	727-136 727-138	25 25		
	8-level end plate; 7.62 mm thick	● orange ○ gray	727-117 727-113	25 25	7,62 x 58,3 x 226 mm / 0.3 x 2.3 x 8.9 inch	

Conductor range: 0.08 ... 1.5 mm<sup>2</sup>; 28 ... 16 AWG;  
Strip length: 8 ... 10 mm / 0.31 ... 0.39 inch

① 250 V = rated voltage  
4 kV = rated impulse voltage  
3 = pollution degree

② suitable for Ex i applications

Accessories: see page 278.

Marking: WMB/WMB Inline/Marking strips

Suitable operating tool: see page 279.

# WAGO Busbar Terminal Block – 812 Series

## 4 / 16 mm<sup>2</sup>

Image	Description	Color	Item No.	PU	Dimensions (W x H x D)	Electrical Data
<b>Busbar terminal block (4 mm<sup>2</sup>)</b>						
	Busbar terminal block (4 mm <sup>2</sup> ); with Push-in CAGE CLAMP® connection	● blue	812-104	10	75 x 30 x 27,5 mm / 2.95 x 1.18 x 1.08 inch	1000 V/6 kV/3 ①; I <sub>N</sub> 96 A; 600 V, 20 A ②; 600 V, 95 A ③
		○ light gray	812-101	10		
		● dark gray	812-102	10		
		● red	812-103	10		
		● green-yellow	812-100	10		
	Ground busbar terminal block (4 mm <sup>2</sup> ); with Push-in CAGE CLAMP® connection				75 x 30 x 27,5 mm / 2.95 x 1.18 x 1.08 inch	
	Busbar; tin-plated; 1000 mm long; Copper (10 x 3) mm		210-133	1		
<b>Busbar terminal block (16 mm<sup>2</sup>)</b>						
	Busbar terminal block (16 mm <sup>2</sup> ); with CAGE CLAMP® connection	● blue	812-114	12	38 x 42,5 x 43,5 mm / 1.5 x 1.67 x 1.71 inch	1000 V/6 kV/3 ①; I <sub>N</sub> 96 A; 600 V, 20 A ②; 600 V, 95 A ③
		○ light gray	812-111	12		
		● dark gray	812-112	12		
		● red	812-113	12		
		● green-yellow	812-110	12		
	Ground busbar terminal block (16 mm <sup>2</sup> ); with CAGE CLAMP® connection				38 x 42,5 x 43,5 mm / 1.5 x 1.67 x 1.71 inch	
	Busbar; tin-plated; 1000 mm long; Copper (10 x 3) mm		210-133	1		
	Finger guard; touch-proof cover protects unused conductor entries	● yellow	284-400	25		
<b>Busbar carrier</b>						
	Insulated busbar carrier; 12 mm wide	○ gray	812-140	25	12 x 41,7 x 80 mm / 0.47 x 1.64 x 3.15 inch	
	Ground busbar carrier; with DIN-35 rail contact; 11 mm wide	● green-yellow	812-141	25	11 x 36 x 54,5 mm / 0.43 x 1.42 x 2.11 inch	



Snapping a ground busbar terminal block onto the N-busbar



Unlock right and left positions to remove the ground busbar terminal block. Then pull up the block from the busbar.

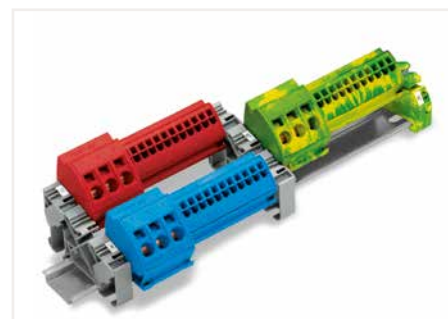

Mixed 4 mm<sup>2</sup> (12 AWG) and 16 mm<sup>2</sup> (6 AWG) busbar terminal blocks

① Conductor range: 0.08 ... 1.5 mm<sup>2</sup>; 28 ... 16 AWG;  
Strip length: 8 ... 10 mm / 0.31 ... 0.39 inch

Accessories: see page 281.

② Conductor range: 0.08 ... 1.5 mm<sup>2</sup>; 28 ... 16 AWG;  
Strip length: 8 ... 10 mm / 0.31 ... 0.39 inch

Suitable operating tool: see page 279.

③ 500 V = rated voltage  
6 kV = rated impulse voltage  
3 = pollution degree

# WAGO Mini Terminal Blocks TOPJOB® S – 2050/2250 Series Operation

1



Insert solid conductors or fine-stranded conductors with ferrules via push-in termination.



Insert fine-stranded conductors via operating tool.



Remove all conductors via operating tool.



Snapping a marking strip (2009-110) into a marker slot.



Testing with a 2 mm Ø 210-136 Test Plug (max. 42 V).



Insert a push-in type jumper bar and push down until it hits the backstop (example shows a 2000-406/020-000 Delta Jumper).



Separate terminal block assembly and slide individual terminal blocks laterally using an operating tool.



Mounting a terminal strip with snap-in feet into drilled holes.





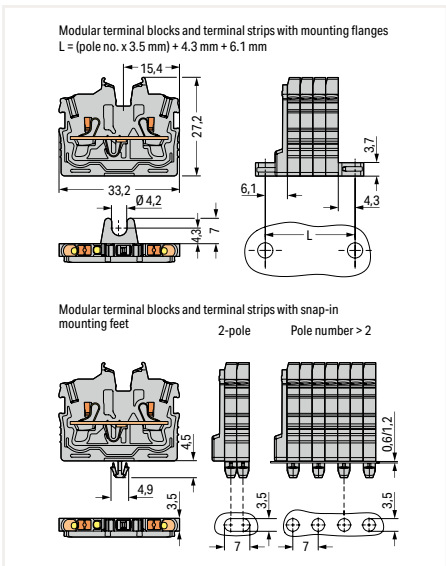





Terminal strip with mounting flanges for screw mounting



Marking strip (2009-110) inserted in the marking slot with jumper symbols of the inserted jumper – delta jumper (2000-406/020-000)

## WAGO Mini Through/Ground Terminal Block TOPJOB® S – 2050/2250 Series

1 (1,5) mm<sup>2</sup>

Image	Description	Color	With Push-Button Item No.	Without Push-Button Item No.	PU	Dimensions (W x H x D)	Electrical Data
<b>2-conductor through terminal block; for DIN-15 rail</b>							
	2-conductor through terminal block	○ gray	2250-1201	2050-1201	100	3,5 x 28 x 34 mm / 0.14 x 1.1 x 1.34 inch	500 V/6 kV/3 ①; I <sub>N</sub> 13,5 A (17,5 A);
	2-conductor through terminal block	● blue	2250-1204 ②	2050-1204 ②	100		
	2-conductor ground terminal block	● green-yellow	2250-1207	2050-1207	100		
	End and intermediate plate; 1 mm thick	○ gray	2050-1291	2050-1291	25	1,1 x 25,2 x 32,5 mm / 0.04 x 0.99 x 1.28 inch	
<b>2-conductor through terminal block; with mounting flange; for screw or similar mounting types; 4.2 mm mounting hole diameter</b>							
	2-conductor through terminal block	○ gray	2250-301	2050-301	100	3,5 x 27,2 x 33,2 mm / 0.14 x 1.1 x 1.31 inch	500 V/6 kV/3 ①; I <sub>N</sub> 13,5 A (17,5 A);
	2-conductor through terminal block	● blue	2250-304 ②	2050-304 ②	100		
	2-conductor ground terminal block	● green-yellow	2250-307	2050-307	100		
	End and intermediate plate; 1 mm thick	○ gray	2050-381	2050-381	25	1,3 x 25,2 x 32,1 mm / 0.05 x 0.99 x 1.26 inch	
<b>2-conductor through terminal block; with snap-in mounting foot; for 0.6 ... 1.2 mm plate thickness; 3.5 mm mounting hole diameter</b>							
	2-conductor through terminal block	○ gray	2250-311	2050-311	100	3,5 x 27,2 x 33,2 mm / 0.14 x 1.1 x 1.31 inch	500 V/6 kV/3 ①; I <sub>N</sub> 13,5 A (17,5 A);
	2-conductor through terminal block	● blue	2250-314 ②	2050-314 ②	100		
	2-conductor ground terminal block	● green-yellow	2250-317	2050-317	100		
	End and intermediate plate; 1 mm thick	○ gray	2050-391	2050-391	25	3,4 x 25,2 x 32,1 mm / 0.13 x 0.99 x 1.26 inch	
<b>2-conductor through terminal block; Center terminal block; for 0.6 ... 1.2 mm plate thickness</b>							
	2-conductor through terminal block	○ gray	2250-321	2050-321	100	3,5 x 27,2 x 33,2 mm / 0.14 x 1.1 x 1.31 inch	500 V/6 kV/3 ①; I <sub>N</sub> 13,5 A (17,5 A);
	2-conductor through terminal block	● blue	2250-324 ②	2050-324 ②	100		
	2-conductor ground terminal block	● green-yellow	2250-327	2050-327	100		
	End and intermediate plate; 1 mm thick	○ gray	2050-1291	2050-1291	25	1,1 x 25,2 x 32,5 mm / 0.04 x 0.99 x 1.28 inch	
<b>Accessories</b>							
	Mounting foot; snaps onto terminal blocks with snap-in mounting foot; 6.4 mm wide	○ gray	209-120	209-120	25		
	Aluminum DIN-rail; 1000 mm long; 18 mm wide; 7 mm high	○ silver	210-154	210-154	1		



Terminal blocks on a DIN-rail



Terminal blocks with a mounting flange



Terminal blocks with snap-in mounting feet

Conductor range: 0.14 ... 1.5 mm<sup>2</sup> "s+f-st"; Push-in termination: 0.5 ... 1.5 mm<sup>2</sup> "s" and 0.5 ... 0.75 mm<sup>2</sup> "insulated ferrules; 10 mm"; 24 ... 16 AWG; Strip length: 9 ... 11 mm / 0.35 ... 0.43 inch

① 500 V = rated voltage  
6 kV = rated impulse voltage  
3 = pollution degree  
② suitable for Ex i applications

Accessories: see page 38.  
Marking: WMB/WMB Inline/Marking strips  
Suitable operating tool: see page 39.



# WAGO Mini Through Terminal Block; Front-Entry Wiring; WAGO Terminal Strip – 264 Series

## 2,5 mm<sup>2</sup>

Image	Description	Color	2-Conductor Terminal Block ① Item No.	4-Conductor Terminal Block ② Item No.	PU	Electrical Data
<b>Mini through terminal block</b>						
	End terminal block; with mounting flange; for screw or similar mounting types; 3.2 mm mounting hole diameter	<input type="radio"/> gray <input type="radio"/> blue <input type="radio"/> orange <input type="radio"/> green-yellow <input type="radio"/> light gray	264-301 264-304 ② 264-306 264-307 264-130 ③	264-331 264-334 ② 264-336 264-337 264-230 ③	100	800 V/8 kV/3 ①; I <sub>N</sub> 24 A; 300 V, 20 A ②; 600 V, 20 A ③
	Center terminal block; required between end plate and end terminal block for terminal strips with mounting flanges	<input type="radio"/> gray <input type="radio"/> blue <input type="radio"/> orange <input type="radio"/> green-yellow <input type="radio"/> light gray	264-321 264-324 ② 264-326 264-327 264-131 ③	264-351 264-354 ② 264-356 264-357 264-231 ③	100	800 V/8 kV/3 ①; I <sub>N</sub> 24 A; 300 V, 20 A ②; 600 V, 20 A ③
	Center terminal block; with snap-in mounting foot; required between end plate and end terminal block for terminal strips with mounting flanges	<input type="radio"/> gray <input type="radio"/> blue <input type="radio"/> orange <input type="radio"/> green-yellow <input type="radio"/> light gray	264-311 264-314 ② 264-316 264-317 264-180 ③	264-341 264-344 ② 264-346 264-347 264-280 ③	100	800 V/8 kV/3 ①; I <sub>N</sub> 24 A; 300 V, 20 A ②; 600 V, 20 A ③
	End and intermediate plate; 4 mm thick	<input type="radio"/> orange <input type="radio"/> gray <input type="radio"/> light gray	264-361 264-364 264-363	264-361 264-364 264-363	25	
	Mini through terminal block; for DIN-35 rail	<input type="radio"/> gray <input type="radio"/> blue <input type="radio"/> orange <input type="radio"/> light gray	264-711 264-714 ② 264-716 264-125 ③	264-731 264-734 ② 264-736 264-225 ③	100	800 V/8 kV/3 ①; I <sub>N</sub> 24 A; 300 V, 20 A ②; 600 V, 20 A ③
	Mini ground terminal block; for DIN-35 rail	<input type="radio"/> green-yellow <input type="radio"/> green-yellow		264-737 264-737/999-950 ③	100	
	End and intermediate plate; 4 mm thick	<input type="radio"/> orange <input type="radio"/> gray <input type="radio"/> light gray	264-369 264-368 264-370	264-369 264-368 264-370	25	
<b>Terminal strips</b>						
	Terminal strips; with mounting flanges					
	2-pole	<input type="radio"/> gray	264-102	264-202	100	800 V/8 kV/3 ①; I <sub>N</sub> 24 A; 300 V, 20 A ②; 600 V, 20 A ③
	⋮		⋮	⋮		
	12-pole	<input type="radio"/> gray	264-112	264-212	25	
	Terminal strips; with snap-in mounting feet					
	2-pole	<input type="radio"/> gray	264-152	264-252	100	800 V/8 kV/3 ①; I <sub>N</sub> 24 A; 300 V, 20 A ②; 600 V, 20 A ③
	⋮		⋮	⋮		
	12-pole	<input type="radio"/> gray	264-162	264-262	25	
<b>Accessories</b>						
	Comb-style jumper bar; insulated; reduces maximum conductor size to 1.5 mm <sup>2</sup> ; I <sub>N</sub> 16 A;	<input type="radio"/> gray	264-402	264-402	25	

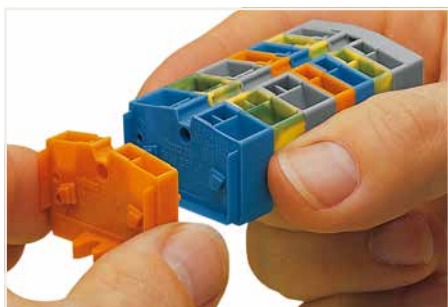

Mounting an "end terminal block" with mounting flange.



Mounting and securing a terminal strip directly to the plate via screw-type flanges.



Commoning with comb-style jumper bar.

Conductor range: 0.08 ... 2.5 mm<sup>2</sup>; 28 ... 12 AWG;  
Strip length: 8 ... 9 mm / 0.31 ... 0.35 inch

① Dimensions of 2-conductor terminal blocks (W x H x D): 6 x 22,1 x 32 mm / 0.24 x 0.87 x 1.26 inch

② Dimensions of 4-conductor terminal blocks (W x H x D): 10 x 22,1 x 32 mm / 0.39 x 0.87 x 1.26 inch

① 800 V = rated voltage  
8 kV = rated impulse voltage  
3 = pollution degree

② suitable for Ex i applications

③ Suitable for Ex e II applications; 690 V; 23 A

Accessories: see page 270.

Marking: WMB/WMB Inline/Marking strips

Suitable operating tool: see page 279.

# WAGO Mini Through Terminal Blocks; Side-Entry Wiring; WAGO Terminal Strips – 260 / 261 / 262 Series Operation

1

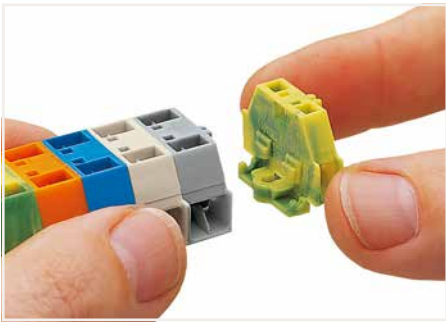

Assembling modular terminal blocks into terminal strips.

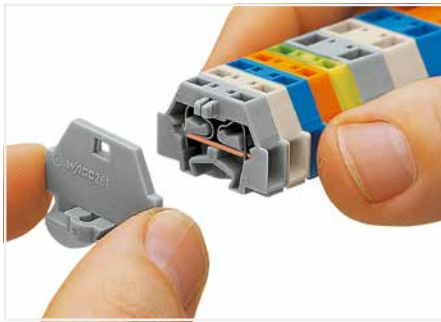

Mounting an end plate.

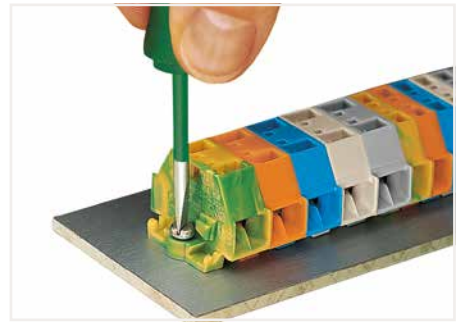

Mounting and securing a terminal strip directly to the plate via screw-type flanges.



Inserting a conductor.

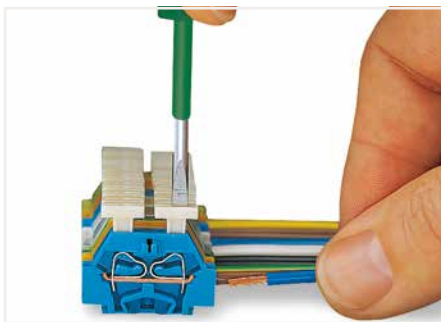

Inserting a conductor via push-button.



Securing a mounting foot (209-123) to the terminal strip with mounting flanges (distance between mounting feet approx. 35 ... 40 mm).



Marking with self-adhesive marking strips.



Marking by direct printing (upon request).

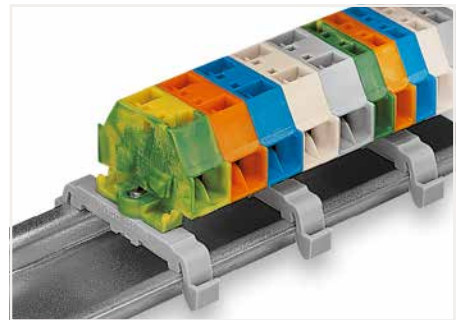

Terminal strip with mounting flanges on DIN-35 rail

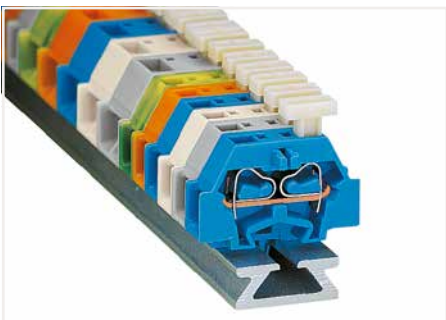

Terminal strip with push-buttons on one side

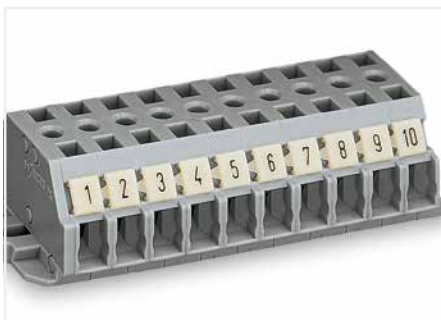

Terminal strip with marker slot for Mini-WSB Quick marking system (see Full Line Catalog, Volume 6).

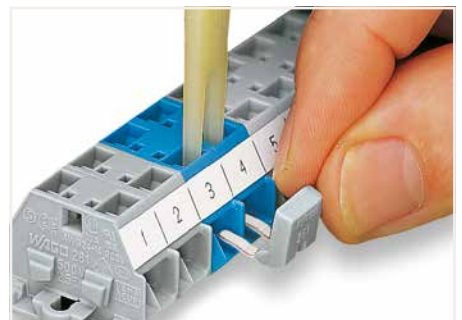











Commoning with comb-style jumper bar.

# WAGO Mini Through Terminal Block; Side-Entry Wiring; WAGO Terminal Strips

## - 260 / 261 / 262 Series

### 1,5 / 2,5 / 4 mm<sup>2</sup>

Image	Description	Color	2-Conductor Terminal Block Item No.	4-Conductor Terminal Block Item No.	PU	Electrical Data	
<b>Modular terminal block/terminal strip; 1.5 mm<sup>2</sup> ①</b>							
	Terminal block; with mounting flange; for screw or similar mounting types; 3.2 mm mounting hole diameter	○ gray	260-301	260-331	300	400 V/6 kV/3 ④; I <sub>n</sub> 18 A; 300 V, 10 A ⑤; 300 V, 15 A ⑥	
		○ light gray	260-303	260-333	300		
		● blue	260-304	260-334	300		
		● orange	260-306	260-336	300		
		● green-yellow	260-307	260-337	300		
	End plate; with mounting flange	○ gray	260-361	260-361	50		
	Terminal strip; with mounting flanges; for screw or similar mounting types; 3.2 mm mounting hole diameter					400 V/6 kV/3 ④; I <sub>n</sub> 18 A; 300 V, 10 A ⑤; 300 V, 15 A ⑥	
		2-pole	○ gray	260-102	260-202		100
		⋮		⋮	⋮		
	12-pole	○ gray	260-112	260-212	25		
<b>Modular terminal block; 2.5 mm<sup>2</sup> ②</b>							
	Terminal block; with mounting flange; for screw or similar mounting types; 3.2 mm mounting hole diameter	○ gray	261-301	261-331	200	500 V/6 kV/3 ④; I <sub>n</sub> 24 A; 300 V, 15 A ⑤; 300 V, 20 A ⑥	
		○ light gray	261-303	261-333	200		
		● blue	261-304 ⑤	261-334 ⑤	200		
		● orange	261-306	261-336	200		
		● green-yellow	261-307	261-337	200		
	End plate; with mounting flange	○ gray	261-361	261-361	50		
	Terminal strip; with mounting flanges; for screw or similar mounting types; 3.2 mm mounting hole diameter					500 V/6 kV/3 ④; I <sub>n</sub> 24 A; 300 V, 15 A ⑤; 300 V, 20 A ⑥	
		2-pole	○ gray	261-102	261-202		100
		⋮		⋮	⋮		
	12-pole	○ gray	261-112	261-212	25		
<b>Modular terminal block; 4 mm<sup>2</sup> ③</b>							
	2-conductor terminal block; with mounting flange; for screw or similar mounting types; 3.2 mm mounting hole diameter	○ gray	262-301	262-331	100	630 V/8 kV/3 ④; I <sub>n</sub> 24 A; 300 V, 20 A ⑤; 300 V, 20 A ⑥	
		● blue	262-304 ⑤	262-334 ⑤	100		
		● orange	262-306	262-336	100		
		● green-yellow	262-307	262-337	100		
	End plate; with mounting flange	○ gray	262-361	262-361	50		
	Terminal strip; with mounting flanges; for screw or similar mounting types; 3.2 mm mounting hole diameter					630 V/8 kV/3 ④; I <sub>n</sub> 24 A; 300 V, 20 A ⑤; 300 V, 20 A ⑥	
		2-pole	○ gray	262-102	262-202		100
		⋮		⋮	⋮		
	12-pole	○ gray	262-112	262-212	25		
<b>Accessories</b>							
	Comb-style jumper bar; insulated; I <sub>n</sub> 16 A						
	for 260 Series; reduces conductor size to 1 mm <sup>2</sup>	○ gray	260-402	260-402	25		
	for 261 Series; reduces conductor size to 1.5 mm <sup>2</sup>	○ gray	261-402	261-402	25		
	for 262 Series; reduces conductor size to 2.5 mm <sup>2</sup>	○ gray	262-402	262-402	25		

**260 Series ①**

Conductor range: 0.08 ... 1.5 mm<sup>2</sup>; 28 ... 16 AWG;  
Strip length: 8 ... 9 mm / 0.31 ... 0.35 inch

Dimensions of 2-conductor terminal block (W x H x D):  
5 x 17 x 25 mm / 0.2 x 0.67 x 0.98 inch

Dimensions of 4-conductor terminal block (W x H x D):  
8 x 17 x 25 mm / 0.32 x 0.67 x 0.98 inch

**261 Series ②**

Conductor range: 0.08 ... 2.5 mm<sup>2</sup>; 28 ... 14 AWG;  
Strip length: 8 ... 9 mm / 0.31 ... 0.35 inch

Dimensions of 2-conductor terminal block (W x H x D):  
6 x 18 x 28 mm / 0.24 x 0.71 x 1.1 inch

Dimensions of 4-conductor terminal block (W x H x D):  
10 x 18 x 28 mm / 0.39 x 0.71 x 1.1 inch

**262 Series ③**

Conductor range: 0.08 ... 4 mm<sup>2</sup>; 28 ... 12 AWG;  
Strip length: 9 ... 10 mm / 0.35 ... 0.39 inch

Dimensions of 2-conductor terminal block (W x H x D):  
7 x 23 x 33,5 mm / 0.28 x 0.91 x 1.32 inch

Dimensions of 4-conductor terminal block (W x H x D):  
12 x 23 x 33,5 mm / 0.47 x 0.91 x 1.32 inch

**General**

④ 400/500/630 V = rated voltage;  
6/8 kV = rated impulse voltage;  
3 = pollution degree

⑤ suitable for Ex i applications

Accessories: see page 281.

Suitable operating tool: see page 279.

# WAGO Chassis-Mount Terminal Strip – 862 Series

## 4 mm<sup>2</sup>

2

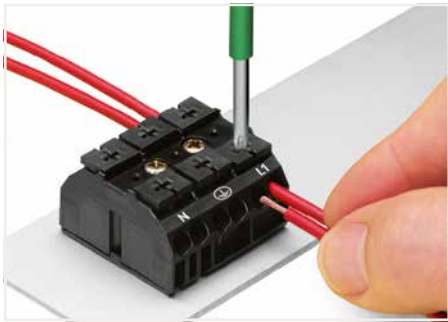

Terminating four conductors per pole – solid and fine-stranded.



Inserting a conductor via push-button.



Testing with a 2 mm Ø test plug (max. 42 V).



Makes an automatic contact to the mounting plate. The plate's varnish is instantly penetrated.



Commoning using a comb-style jumper bar (862-482).

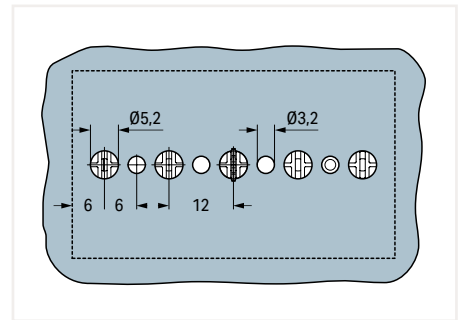

Dimensions (in mm) for GND contact and snap-in mounting foot (Ø 5.2 mm)

Image	Pole Number	Marking	Description	Color	Item No.	Color	Item No.	PU
<b>4-conductor chassis-mount terminal strip; for mounting via screw and nut (3 mm Ø) or for self-tapping screw (2.9 mm Ø) from top; white</b>								
	2	N-L1	with 2 x pin	● black	862-2552	○ white	862-2652	500
	2	L1-N	with 2 x pin	● black	862-1552	○ white	862-1652	500
	2	L1-N	with 2 x pin	● black	862-1552/999-950 ①	○ white	862-1652/999-950 ①	500
	2	plain	with 2 x pin	● black	862-552	○ white	862-652	500
	3	N-PE-L1	without GND contact	● black	862-2503	○ white	862-2603	250
	3	PE-N-L1	without GND contact	● black	862-1503	○ white	862-1603	250
	3	PE-N-L1	without GND contact	● black	862-1503/999-950 ①	○ white	862-1603/999-950 ①	250
	3	plain	without GND contact	● black	862-503	○ white	862-603	250
	3	N-PE-L1	with GND contact	● black	862-8503	○ white	862-8603	250
	3	PE-N-L1	with GND contact	● black	862-9503	○ white	862-9603	250
	4	N-PE-L1-L2	without GND contact	● black	862-2504	○ white	862-2604	200
	4	PE-N-L1-L2	without GND contact	● black	862-1504	○ white	862-1604	200
	4	PE-N-L1-L2	without GND contact	● black	862-1504/999-950 ①	○ white	862-1604/999-950 ①	200
	4	plain	without GND contact	● black	862-504	○ white	862-604	200
	4	N-PE-L1-L2	with GND contact	● black	862-8504	○ white	862-8604	200
	4	PE-N-L1-L2	with GND contact	● black	862-9504	○ white	862-9604	200
	5	L3-N-PE-L1-L2	without GND contact	● black	862-2505	○ white	862-2605	200
	5	PE-N-L1-L2-L3	without GND contact	● black	862-1505	○ white	862-1605	200
	5	PE-N-L1-L2-L3	without GND contact	● black	862-1505/999-950 ①	○ white	862-1605/999-950 ①	200
	5	plain	without GND contact	● black	862-505	○ white	862-605	200
5	L3-N-PE-L1-L2	with GND contact	● black	862-8505	○ white	862-8605	200	
5	PE-N-L1-L2-L3	with GND contact	● black	862-9505	○ white	862-9605	200	





Conductor range: 0.5 ... 4 mm<sup>2</sup> "s+f-st"; Push-in termination: 1 ... 4 mm<sup>2</sup> "s" and 1 ... 2.5 mm<sup>2</sup> "insulated ferrules; 12 mm"; 20 ... 12 AWG; Strip length: 10 ... 11 mm / 0.39 ... 0.43 inch

500 V/6 kV/3; I<sub>N</sub> 32 A; 300 V, 20 A **VA**; 300 V, 20 A **®**  
 500 V = rated voltage  
 8 kV= rated impulse voltage  
 3 = pollution degree

① Suitable for Ex e II applications; 440 V; 28 A  
 Accessories: see page 281.

# WAGO Chassis-Mount Terminal Strip – 862 Series

## 4 mm<sup>2</sup>

Image	Pole Number	Marking	Description	Color	Item No.	Color	Item No.	PU
<b>4-conductor chassis-mount terminal strip; for self-tapping screw (2.9 mm Ø) from below</b>								
	2	N-L1	with 2 x pin	● black	862-2562	○ white	862-2662	500
	2	L1-N	with 2 x pin	● black	862-1562	○ white	862-1662	500
	2	L1-N	with 2 x pin	● black	862-1562/999-950 ①	○ white	862-1662/999-950 ①	500
	2	plain	with 2 x pin	● black	862-562	○ white	862-662	500
<b>4-conductor chassis-mount terminal strip; 1 snap-in foot per pole</b>								
	2	N-L1		● black	862-2532	○ white	862-2632	500
	2	L1-N		● black	862-1532	○ white	862-1632	500
	2	L1-N		● black	862-1532/999-959 ①	○ white	862-1632/999-959 ①	500
	2	plain		● black	862-532	○ white	862-632	500
	3	N-PE-L1	without GND contact	● black	862-2533	○ white	862-2633	250
	3	PE-N-L1	without GND contact	● black	862-1533	○ white	862-1633	250
	3	PE-N-L1	without GND contact	● black	862-1533/999-950 ①	○ white	862-1633/999-950 ①	250
	3	plain	without GND contact	● black	862-533	○ white	862-633	250
	3	N-PE-L1	with GND contact	● black	862-8533	○ white	862-8633	250
	3	PE-N-L1	with GND contact	● black	862-9533	○ white	862-9633	250
	4	N-PE-L1-L2	without GND contact	● black	862-2534	○ white	862-2634	200
	4	PE-N-L1-L2	without GND contact	● black	862-1534	○ white	862-1634	200
	4	PE-N-L1-L2	without GND contact	● black	862-1534/999-950 ①	○ white	862-1634/999-950 ①	200
	4	plain	without GND contact	● black	862-534	○ white	862-634	200
	4	N-PE-L1-L2	with GND contact	● black	862-8534	○ white	862-8634	200
	4	PE-N-L1-L2	with GND contact	● black	862-9534	○ white	862-9634	200
	5	L3-N-PE-L1-L2	without GND contact	● black	862-2525	○ white	862-2625	200
	5	PE-N-L1-L2-L3	without GND contact	● black	862-1525	○ white	862-1625	200
	5	PE-N-L1-L2-L3	without GND contact	● black	862-1525/999-950 ①	○ white	862-1625/999-950 ①	200
	5	plain	without GND contact	● black	862-525	○ white	862-625	200
5	L3-N-PE-L1-L2	with GND contact	● black	862-8525	○ white	862-8625	200	
5	PE-N-L1-L2-L3	with GND contact	● black	862-9525	○ white	862-9625	200	
<b>4-conductor chassis-mount terminal strip; Snap-in foot at pos. 1+3</b>								
	3	N-PE-L1	without GND contact	● black	862-2593	○ white	862-2693	250
	3	PE-N-L1	without GND contact	● black	862-1593	○ white	862-1693	250
	3	PE-N-L1	without GND contact	● black	862-1593/999-950 ①	○ white	862-1693/999-950 ①	250
	3	plain	without GND contact	● black	862-593	○ white	862-693	250
	3	N-PE-L1	with GND contact	● black	862-8593	○ white	862-8693	250
	3	PE-N-L1	with GND contact	● black	862-9593	○ white	862-9693	250
<b>4-conductor chassis-mount terminal strip; Snap-in foot at pos. 1+4</b>								
	4	N-PE-L1-L2	without GND contact	● black	862-2594	○ white	862-2694	200
	4	PE-N-L1-L2	without GND contact	● black	862-1594	○ white	862-1694	200
	4	PE-N-L1-L2	without GND contact	● black	862-1594/999-950 ①	○ white	862-1694/999-950 ①	200
	4	plain	without GND contact	● black	862-594	○ white	862-694	200
	4	N-PE-L1-L2	with GND contact	● black	862-8594	○ white	862-8694	200
	4	PE-N-L1-L2	with GND contact	● black	862-9594	○ white	862-9694	200
<b>4-conductor chassis-mount terminal strip; Snap-in foot at pos. 1+3+5</b>								
	5	L3-N-PE-L1-L2	without GND contact	● black	862-2515	○ white	862-2615	200
	5	PE-N-L1-L2-L3	without GND contact	● black	862-1515	○ white	862-1615	200
	5	PE-N-L1-L2-L3	without GND contact	● black	862-1515/999-950 ①	○ white	862-1615/999-950 ①	200
	5	plain	without GND contact	● black	862-515	○ white	862-615	200
	5	L3-N-PE-L1-L2	with GND contact	● black	862-8515	○ white	862-8615	200
	5	PE-N-L1-L2-L3	with GND contact	● black	862-9515	○ white	862-9615	200

2

# WAGO Field-Wiring Terminal Block for Lighting and Electrical Equipment – 294 Series

## 2,5 mm<sup>2</sup>

2

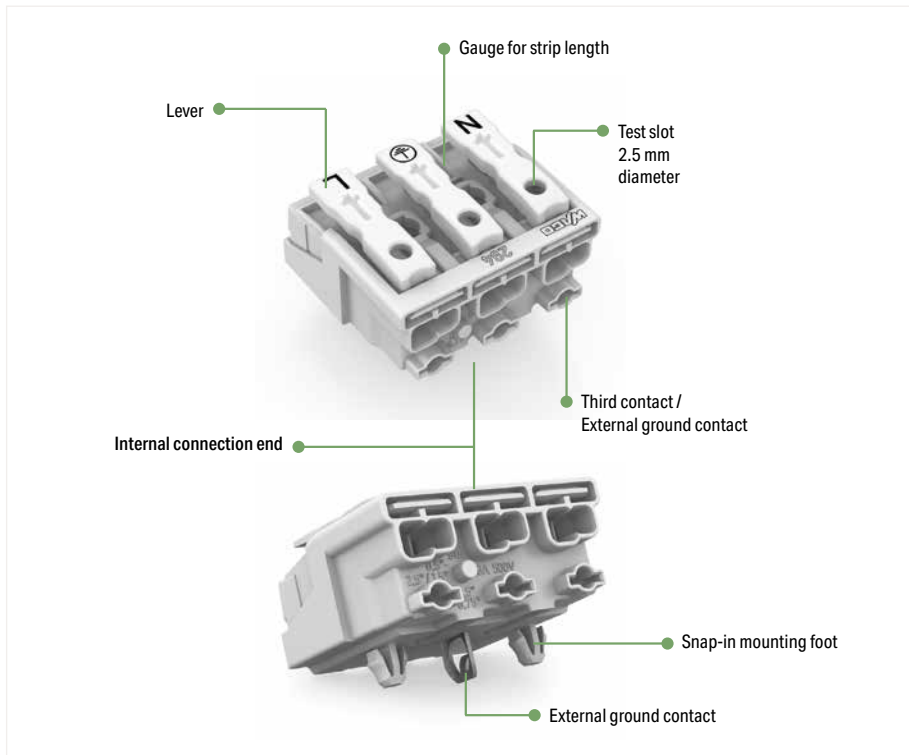

EUROPE
1 x 0.5 ... 2.5 mm <sup>2</sup> "s"
1 x 0.5 ... 1.5 mm <sup>2</sup> "s"
1 x 0.5 ... 0.75 mm <sup>2</sup> "s"
AMERICA
1 x AWG 18 ... 14 "s"
1 x AWG 18 ... 16 "s"
1 x AWG 18 "s"
JAPAN
1 x 0.8 ... 1.6 mm diam. "s"
1 x 0.8 ... 1 mm diam. "s"
1 x 0.8 mm diam. "s"

**Internal connection:**

PUSH WIRE® for internal wiring with solid conductors

EUROPE
2 x 0.5 ... 2.5 mm <sup>2</sup> "s, str, f-str"
AMERICA
2 x AWG 18 ... 12 "s"
2 x AWG 18 ... 14 "s, f-str"
JAPAN
2 x 0.8 ... 2 mm diam. "s"
2 x 0.5 ... 2 mm <sup>2</sup> "str, f-str"

**External connection:**

Push-in CAGE CLAMP® for field-wiring with all conductor types



Image	Pole Number	Marking	without GND contact Item No.	With Direct GND Contact Item No.	With Screw-Type GND Contact Item No.	With Snap-In GND Contact Item No.	With Angled Snap-In GND Contact Item No.
<b>Lighting terminal blocks; with 2 snap-in mounting feet</b>							
	2	plain	294-5002				
	2	N L	294-5012				
	2	N' L'	294-5022				
	2	DA- DA+	294-5032				
	2	- +	294-5072				
	2	1 N	294-5052				
	2	2 1	294-5042				
	3	plain	294-5003				
	3	N PE L	294-5013	294-5113	294-5413	294-5213	294-5313
	3	N' PE L'	294-5023	294-5123	294-5423	294-5223	294-5323
	3	1 PE N	294-5053	294-5153	294-5153	294-5253	294-5353
	4	plain	294-5004				
	4	1/L' 2/L PE N	294-5024	294-5124	294-5424	294-5224	294-5324
	4	1 2 PE N	294-5014	294-5114	294-5414	294-5214	294-5314
	4	4 3 2 1	294-5044				
	4	1/L' 2/L E N	294-5094/4025-000				
	5	plain	294-5005				
	5	L3 L2 L1 PE N	294-5015		294-5415	294-5215	294-5315
	5	L' N' L PE N	294-5025		294-5425	294-5225	294-5325
	5	DA+ DA- L PE N	294-5035		294-5435	294-5235	294-5335
	5	DA- N PE L DA+	294-5075	294-5175	294-5475	294-5275	294-5375
	5	3 N PE 1 2	294-5055	294-5155	294-5455	294-5255	294-5355
	5	5 4 3 2 1	294-5045				
	5	DA+ DA- L E N	294-5095/5025-000				
	5	L3 L2 L1 E N	294-5095/5026-000				
	5	L' N' L E N	294-5095/5027-000				

## WAGO Field-Wiring Terminal Block for Lighting and Electrical Equipment – 294 Series

### 2,5 mm<sup>2</sup>











Image	Pole Number	Marking	without GND contact Item No.	With Direct GND Contact Item No.	With Screw-Type GND Contact Item No.	With Snap-In GND Contact Item No.	With Angled Snap-In GND Contact Item No.
<b>Lighting terminal blocks; without snap-in mounting feet</b>							
	2	plain	294-4002				
	2	N L	294-4012				
	2	N' L'	294-4022				
	2	DA- DA+	294-4032				
	2	- +	294-4072				
	2	1 N	294-4052				
	2	2 1	294-4042				
	3	plain	294-4003				
	3	N PE L	294-4013		294-4413	294-4213	294-4313
	3	N' PE L'	294-4023		294-4423	294-4223	294-4323
	3	1 PE N	294-4053		294-4153	294-4253	294-4353
	4	plain	294-4004				
	4	1/L' 2/L PE N	294-4024		294-4424	294-4224	294-4324
	4	1 2 PE N	294-4014		294-4414	294-4214	294-4314
	4	4 3 2 1	294-4044				
	4	1/L' 2/L E N	294-4094/4025-000				
	5	plain	294-4005				
	5	L3 L2 L1 PE N	294-4015		294-4415	294-4215	294-4315
	5	L' N' L PE N	294-4025		294-4425	294-4225	294-4325
	5	DA+ DA- L PE N	294-4035		294-4435	294-4235	294-4335
	5	DA- N PE L DA+	294-4075		294-4475	294-4275	294-4375
	5	3 N PE 1 2	294-4055		294-4455	294-4255	294-4355
	5	5 4 3 2 1	294-4045				
	5	DA+ DA- L E N	294-4095/5025-000				
	5	L3 L2 L1 E N	294-4095/5026-000				
	5	L' N' L E N	294-4095/5027-000				
	6	plain	294-4006				
	7	plain	294-4007				

Image	Description	Color	Item No.	PU
<b>294 Series Accessories</b>				
	Assembly tool; presses snap-in mounting feet into the mounting plate; fits ground connections safely and easily		294-199	50
	Disconnection tool; removes conductors from PUSH WIRE® connections	● green	206-294	1
	Strain relief plate; with locking clip; for multicore cable: 1 x 5.2 ... 12 mm outer diameter	○ white	294-364	50
	Strain relief plate; with locking clip; for flat cables and individual conductors: min. 3 x 0.5 mm <sup>2</sup> , max. 5 x 2.5 mm <sup>2</sup> or 7 x 1.5 mm <sup>2</sup>	○ white	294-384	50
	Strain relief; with snap-in mounting feet; for 4.5 ... 12 mm cable diameter	○ white	294-370	500
	Strain relief; for screw/rivet mounting; for 4.5 ... 12 mm cable diameter	○ white	294-375	500

The following packaging units (PU) apply to the field-wiring terminal blocks:

Pole no. 2 = 1000; Pole no. 3 = 500; Pole no. 4 = 500 VPE; Pole no. 5 = 250; Pole no. 6 = 200; Pole no. 7 = 200

Conductor range: 0.5 ... 2.5 mm<sup>2</sup> "s+f-st"; Push-in termination: 0.5 ... 2.5 mm<sup>2</sup> "s" and 0.5 ... 1.5 mm<sup>2</sup> "insulated ferrules; 12 mm"; 18 ... 12 AWG;  
Strip length: 8 ... 9 mm / 0.31 ... 0.35 inch

500 V/4 kV/2; I<sub>n</sub> 24 A  
500 V = rated voltage  
4 kV = rated impulse voltage  
2 = pollution degree

Accessories: see page 281.

## WAGO COMPACT Splicing Connectors – 221 Series Description and Installation

2

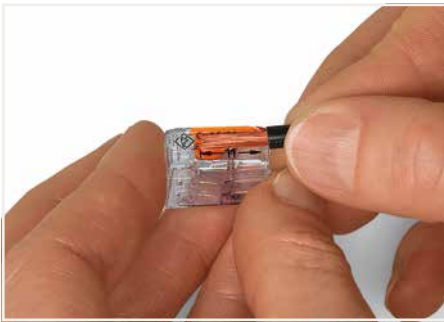

Stripping a conductor.

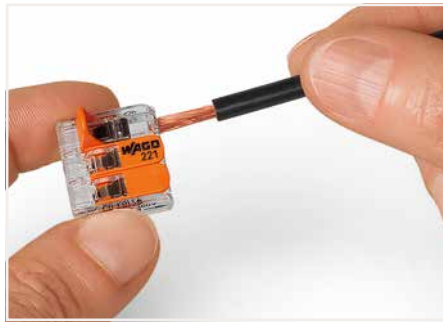

Termination: Lift the lever to open the clamping unit and insert a stripped conductor.

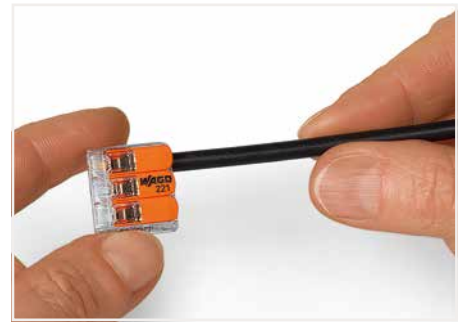

Then, lower the lever to close the clamp.



Mounting carrier



Horizontal screw mounting



Wiring fine-stranded conductors in junction boxes



Vertical mounting with strain relief plate on DIN-35 rail



Create potential distributions with up to eight connection points in the DIN-rail adapter; an optional lock prevents accidentally opening a connection (locking function).



Lighting distribution in a ceiling canopy



Inserting a connector into the mounting carrier.

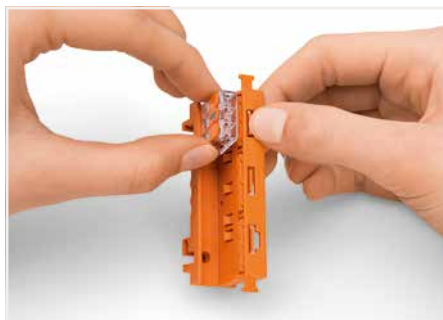

Removing a connector from the mounting carrier.















Removing a conductor.

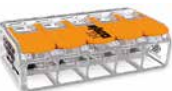

## WAGO COMPACT Splicing Connector – 221 Series

### 4 / 6 mm<sup>2</sup>

Image	Description	Color	Item No.	PU	Dimensions (W x H x D)	Electrical Data
<b>COMPACT splicing connector; 4 mm<sup>2</sup> ①</b>						
	2-wire connector; with levers; transparent housing; orange levers	● orange	221-412	1000	13,1 x 8,3 x 18,6 mm / 0.52 x 0.33 x 0.73 inch	450 V/4 kV/2 ③; I <sub>N</sub> 32 A; 600 V, 20 A ④-
	3-wire connector; with levers; transparent housing; orange levers	● orange	221-413	500	18,7 x 8,3 x 18,6 mm / 0.74 x 0.33 x 0.73 inch	450 V/4 kV/2 ③; I <sub>N</sub> 32 A; 600 V, 20 A ④-
	5-wire connector; with levers; transparent housing; orange levers	● orange	221-415	250	29,9 x 8,3 x 18,6 mm / 1.18 x 0.33 x 0.73 inch	450 V/4 kV/2 ③; I <sub>N</sub> 32 A; 600 V, 20 A ④-
	Mounting carrier for single connectors; for screw mounting; for 2-wire connectors	○ white ● black	221-502 221-502/000-004	50 50	18,1 x 16,9 x 52,8 mm / 0.71 x 0.67 x 2.08 inch	
	Mounting carrier for single connectors; for screw mounting; for 3-wire connectors	○ white ● black	221-503 221-503/000-004	50 50	23,7 x 16,9 x 52,8 mm / 0.93 x 0.67 x 2.08 inch	
	Mounting carrier for single connectors; for screw mounting; for 5-wire connectors	○ white ● black	221-505 221-505/000-004	50 50	35 x 16,9 x 52,8 mm / 1.38 x 0.67 x 2.08 inch	
	Mounting carrier; for 2-, 3- and 5-wire splicing connectors (4 mm <sup>2</sup> ); 17.5 mm wide	● orange	221-500	50	17,5 x 25,5 x 77,6 mm / 1.69 x 1 x 3.06 inch	
		● dark gray/yellow	221-500/000-053	50		
		● blue	221-500/000-006	50		
<b>COMPACT splicing connector; 6 mm<sup>2</sup> ②</b>						
	2-wire connector; with levers; transparent housing; orange levers	● orange	221-612	500	16 x 10,1 x 21,1 mm / 0.63 x 0.4 x 0.83 inch	450 V/4 kV/2 ③; I <sub>N</sub> 41 A; 600 V, 20 A ④-
	3-wire connector; with levers; transparent housing; orange levers	● orange	221-613	300	22,9 x 10,1 x 21,1 mm / 0.9 x 0.4 x 0.83 inch	450 V/4 kV/2 ③; I <sub>N</sub> 41 A; 600 V, 20 A ④-
	5-wire connector; with levers; transparent housing; orange levers	● orange	221-615	150	36,7 x 10,1 x 21,1 mm / 1.45 x 0.4 x 0.83 inch	450 V/4 kV/2 ③; I <sub>N</sub> 41 A; 600 V, 20 A ④-
	Mounting carrier; for 2-, 3- and 5-wire splicing connectors (6 mm <sup>2</sup> ); 17.5 mm wide	● orange	221-510	50	19,3 x 28,3 x 94,2 mm / 0.76 x 1.1 x 3.71 inch	
		● dark gray/yellow	221-510/000-053	50		
		● blue	221-510/000-006	50		
<b>Accessories for all COMPACT splicing connectors</b>						
	Adjacent jumper; with locking contact point lever; for 4 mm <sup>2</sup> and 6 mm <sup>2</sup> 221 Series	○ gray	221-941	50		
		● blue	221-941/000-006	50		
	Adjacent jumper; without locking contact point lever; for 4 mm <sup>2</sup> and 6 mm <sup>2</sup> 221 Series	○ gray	221-942	50		
		● blue	221-942/000-006	50		
	Angled DIN-rail adapter; in combination with mounting carrier (221-500) for DIN-35 rail mounting	○ gray	222-510	50	18,5 x 21,5 x 42 mm / 0.73 x 0.85 x 1.65 inch	
	Strain relief plate; for mounting carrier (221 or 222 Series); snaps on to mounting carrier	● orange	222-505	50	4 x 52 x 67,5 mm / 0.16 x 2.05 x 2.66 inch	

① Conductor range: 0.2 ... 4 mm<sup>2</sup> "s+st";  
0.14 ... 4 mm<sup>2</sup> "f-st" / 24 ... 12 AWG;  
Strip length: 11 mm / 0.43 inch

② Conductor range: 0.5 ... 6 mm<sup>2</sup> / 20 ... 10 AWG;  
Strip length: 12 ... 14 mm / 0.47 ... 0.55 inch

③ 450 V = rated voltage  
4 kV = rated impulse voltage  
2 = pollution degree

Continuous operating temperature (max.): 150 °C  
Surrounding air temperature (max.): 85 °C

# WAGO COMPACT Splicing Connectors; for Ex eb Applications – 221 Series

## Description and Installation

2

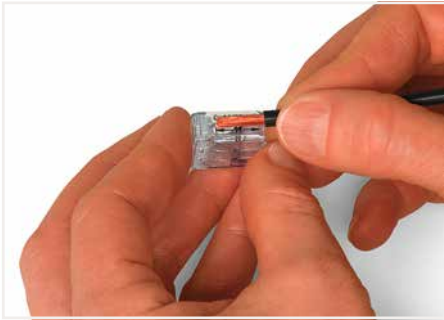

Strip conductor to 11 mm (0.43 inch).

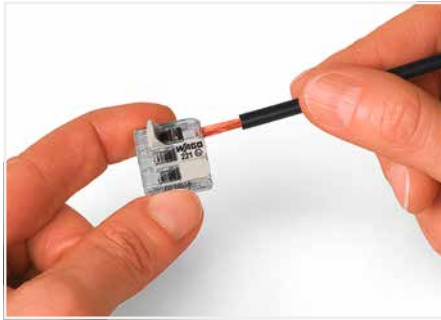

Termination: Lift the lever to open the clamping unit and insert a stripped conductor.

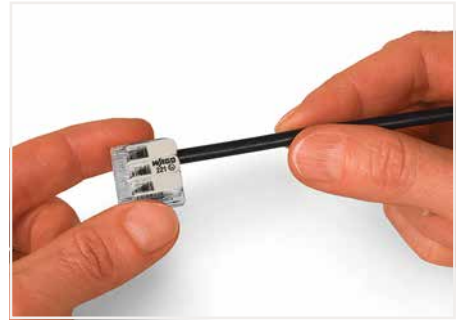

Then, lower the lever to close the clamp.

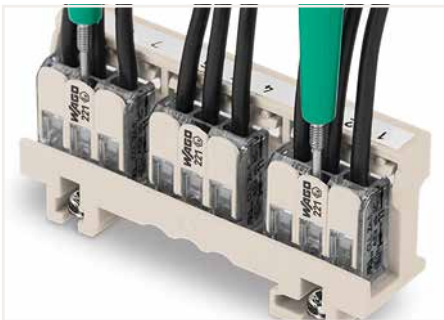

Easily test inserted connectors in the carrier – however they are mounted.



Wiring example in an Ex e junction box  
Labeling is performed via marking strips (210-334) and pen or continuous labels (210-834), which is printed via Smart Printer (258-5000).

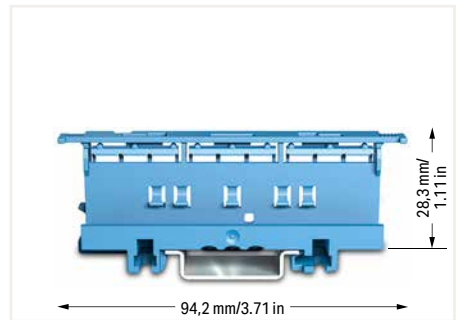

Carriers with a blue insulated housing are suitable for Ex i applications. Both clearances and creepage distances for the protection type "intrinsic safety Ex i" must be observed.

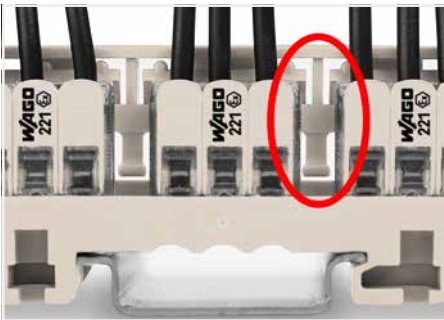

Mounting type (440 V)  
A spacer integrated into the adapter can be seen between two connectors.



Mounting type (440 V)  
Vertical mounting on DIN-35 rail



Mounting type (275 V)  
A spacer integrated in the adapter **cannot** be seen between two connectors; the connector housings are close together.

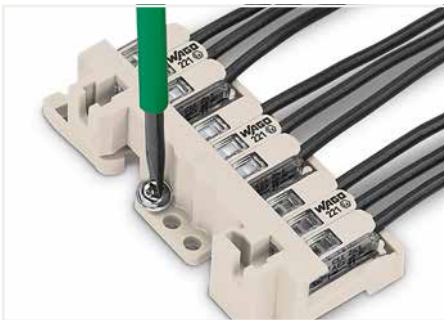

Mounting type (440 V)  
Horizontal screw mounting on a flat surface

















Mounting type (440 V)  
Mounting the carrier via non-conductive screws.



Mounting type (275 V)  
Mounting the carrier using conductive screws.

## WAGO COMPACT Splicing Connector; for Ex eb Applications – 221 Series

### 4 / 6 mm<sup>2</sup>

Image	Description	Color	Item No.	PU	Dimensions (W x H x D)	Electrical Data
<b>COMPACT splicing connector; for Ex eb applications; 4 mm<sup>2</sup> ①⑤</b>						
	2-wire connector; with levers; transparent housing; light gray levers	○ light gray	221-482	1000	13,1 x 8,3 x 18,6 mm / 0.52 x 0.33 x 0.73 inch	440 V (275 V) ③; I <sub>n</sub> 24,5 A; 20 A 
	3-wire connector; with levers; transparent housing; light gray levers	○ light gray	221-483	500	18,7 x 8,3 x 18,6 mm / 0.74 x 0.33 x 0.73 inch	440 V (275 V) ③; I <sub>n</sub> 32 A; 20 A 
	5-wire connector; with levers; transparent housing; light gray levers	○ light gray	221-485	250	29,9 x 8,3 x 18,6 mm / 1.18 x 0.33 x 0.73 inch	440 V (275 V) ③; I <sub>n</sub> 32 A; 20 A 
	Mounting carrier; for 2-, 3- and 5-wire splicing connectors (4 mm <sup>2</sup> ); 17.5 mm wide	○ light gray	221-501	50	17,5 x 25,5 x 77,6 mm /	
		● blue	221-500/000-006 ④	50	0.69 x 1 x 3.06 inch	
<b>COMPACT splicing connector; for Ex eb applications; 6 mm<sup>2</sup> ②⑤</b>						
	2-wire connector; with levers; transparent housing; light gray levers	○ light gray	221-682	500	16 x 10,1 x 21,1 mm / 0.63 x 0.4 x 0.83 inch	440 V (275 V) ③; I <sub>n</sub> 37 A; 20 A 
	3-wire connector; with levers; transparent housing; light gray levers	○ light gray	221-683	300	22,9 x 10,1 x 21,1 mm / 0.9 x 0.4 x 0.83 inch	440 V (275 V) ③; I <sub>n</sub> 37 A; 20 A 
	5-wire connector; with levers; transparent housing; light gray levers	○ light gray	221-685	150	36,7 x 10,1 x 21,1 mm / 1.45 x 0.4 x 0.83 inch	440 V (275 V) ③; I <sub>n</sub> 37 A; 20 A 
	Mounting carrier; for 2-, 3- and 5-wire splicing connectors (4 mm <sup>2</sup> ); 17.5 mm wide	○ light gray	221-511	50	19,3 x 28,3 x 80,8 mm /	
		● blue	221-510/000-006 ④	50	0.76 x 1.11 x 3.18 inch	

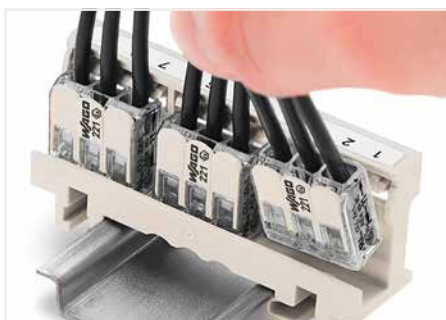

Inserting a connector into the mounting carrier.



Removing a connector from the mounting carrier.



Removing a conductor.

Only approved in conjunction with a mounting carrier (221-501 or 221-511). Other carriers are possible, see certificate (UL).

The connectors must be installed in an enclosure meeting the requirements of a recognized protection type per EN 60079-0, Section 1 or EN 60079-31.

When installing the connectors in an enclosure of protection type "eb" (increased safety) per EN 60079-7, the clearances and creepage distances of Table 2 for this standard must be observed (for using accessories, see point 1).

The connectors can be used both in Group II and Group I, as the standard requirements are identical in this case.

Using of these components requires a new assessment by an authorized certification agency.

① Conductor range: 0.2 ... 4 mm<sup>2</sup> "s+st";  
0.14 ... 4 mm<sup>2</sup> "f-st" / 24 ... 12 AWG; Strip length: 11 mm / 0.43 inch

② Conductor range: 0.5 ... 6 mm<sup>2</sup> / 20 ... 10 AWG;  
Strip length: 12 ... 14 mm / 0.47 ... 0.55 inch







③ The permissible operating voltage of the connector with carrier (440 V or 275 V) depends on the mounting type.

Continuous operating temperature (max.): 150 °C  
Surrounding air temperature (max.): 85 °C

④ Carriers with a blue insulated housing are suitable for Ex i applications. Both clearances and creepage distances for the protection type "intrinsic safety Ex i" must be observed.

⑤ ③: IECEx; Ex eb IIC Gb; ; CII, Zn. 1, AEx eb IIC; CNR Ex eb IIC U

## WAGO Lighting Connector; WAGO Service Connector – 224 Series 2,5 mm<sup>2</sup>

Image	Description	Color	Item No.	PU	Dimensions (W x H x D)	Electrical Data
<b>Lighting connector</b>						
	Lighting connector; 2 connection points <b>1</b> <b>3</b>	○ gray	224-101	1000	8 x 15,5 x 20,4 mm / 0.32 x 0.61 x 0.8 inch	400/4 kV/2 <b>5</b> ; I <sub>n</sub> 24 A
	Lighting connector; 2 connection points <b>1</b> <b>4</b>	● black	224-104	100	8 x 15,5 x 20,4 mm / 0.32 x 0.61 x 0.8 inch	400/4 kV/2 <b>5</b> ; I <sub>n</sub> 24 A
	Lighting connector; 3 connection points <b>2</b> <b>3</b>	○ white	224-112	1000	9,5 x 15,5 x 20,5 mm / 0.37 x 0.61 x 0.81 inch	400/4 kV/2 <b>5</b> ; I <sub>n</sub> 24 A
	Lighting connector; 3 connection points <b>2</b> <b>4</b>	● black	224-114	100	9,5 x 15,5 x 20,5 mm / 0.37 x 0.61 x 0.81 inch	400/4 kV/2 <b>5</b> ; I <sub>n</sub> 24 A
	Service connector; 2 connection points	○ gray	224-201	50	8 x 15,5 x 42 mm / 0.32 x 0.61 x 0.1.65 inch	400/4 kV/2 <b>5</b> ; I <sub>n</sub> 24 A
<b>Accessories</b>						
	Syringe; contains 20 ml "Alu-Plus" Contact Paste		249-130	5		

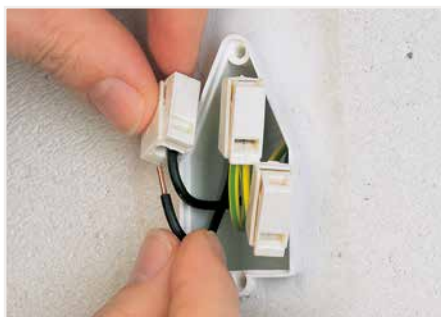
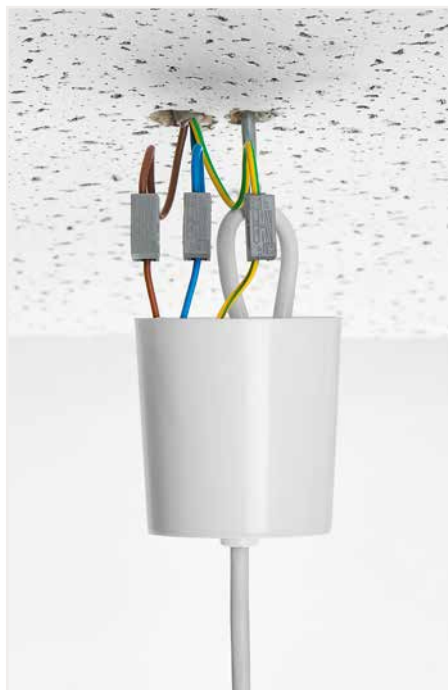

WAGO's lighting connectors ideally connect solid conductors with fine-stranded conductors. Tested and approved as isolated splicing connectors per VDE 0606, they can also be used in applications requiring a connection between solid and fine-stranded conductors. For example, WAGO's lighting connectors connect:

- Blinds, sliding shutters or awning motors
- Window or bathroom fans
- Circulation pumps
- Furnace control systems
- Electrical devices via permanent flexible cables

**1** Installation side: 1 ... 2.5 mm<sup>2</sup> / 14 ... 12 AWG  
Lighting side: 0.5 ... 2.5 mm<sup>2</sup> / 20 ... 16 AWG  
Strip length: 9 ... 11 mm / 0.35 ... 0.43 inch

**3** Continuous operating temperature (max.): 105 °C  
Surrounding air temperature (max.): 60 °C

**5** 400 V = rated voltage  
4 kV = rated impulse voltage  
2 = pollution degree

**2** Installation side: 1 ... 2.5 mm<sup>2</sup> / 16 ... 14 AWG  
Lighting side: 0.5 ... 2.5 mm<sup>2</sup> / 20 ... 16 AWG  
Strip length: 9 ... 11 mm / 0.35 ... 0.43 inch

**4** Continuous operating temperature (max.): 120 °C  
Surrounding air temperature (max.): 75 °C

# WAGO MICRO PUSH WIRE® Connector for Junction Boxes – 243 Series

Ø 0.8 mm

Image	Description	Color	Item No.	PU	Dimensions (W x H x D)	Electrical Data
<b>4-wire connector</b>						
	MICRO PUSH WIRE® connector for junction boxes, 4 wires ①	dark gray	243-204	1000	10 x 5,8 x 10 mm / 0,394 x 0,23 x 0,394 inch	100 V/1,5 kV/2 ①; I <sub>n</sub> 6 A; 150 V, 7 A ②; 150 V, 7 A ③
	MICRO PUSH WIRE® connector for junction boxes, 4 wires ①	red	243-804	1000		
	MICRO PUSH WIRE® connector for junction boxes, 4 wires ①	light gray	243-304	1000		
	MICRO PUSH WIRE® connector for junction boxes, 4 wires ①	yellow	243-504	1000		
	MICRO PUSH WIRE® connector for junction boxes, 4 wires ②	transparent	243-144	1000	10 x 5,8 x 10 mm / 0,394 x 0,23 x 0,394 inch	100 V/1,5 kV/2 ①; I <sub>n</sub> 6 A; 150 V, 7 A ③
<b>8-wire connector</b>						
	MICRO PUSH WIRE® connector for junction boxes, 8 wires ①	dark gray	243-208	500	18,4 x 5,8 x 10 mm / 0,71 x 0,23 x 0,394 inch	100 V/1,5 kV/2 ①; I <sub>n</sub> 6 A; 150 V, 7 A ②; 150 V, 7 A ③
	MICRO PUSH WIRE® connector for junction boxes, 8 wires ①	red	243-808	500		
	MICRO PUSH WIRE® connector for junction boxes, 8 wires ①	light gray	243-308	500		
	MICRO PUSH WIRE® connector for junction boxes, 8 wires ①	yellow	243-508	500		
<b>Modular PCB connector</b>						
	4-conductor modular PCB connector; for individual solder pins	dark gray	243-211	500	10 x 11,5 x 10 mm / 0.4 x 4.5 x 0.4 inch	100 V ≈; I <sub>n</sub> 6 A
	4-conductor modular PCB connector; for individual solder pins	red				
		light gray	243-212	500		
		yellow				
<b>Mounting carrier</b>						
	for 4 connectors	orange	243-112	10		
	for 8 connectors	orange	243-113	10		

2

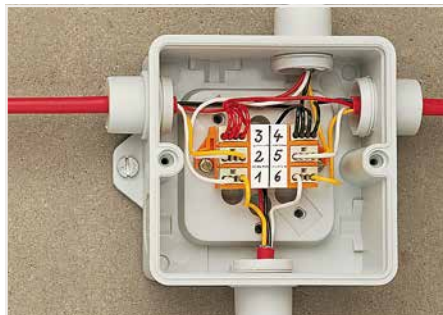
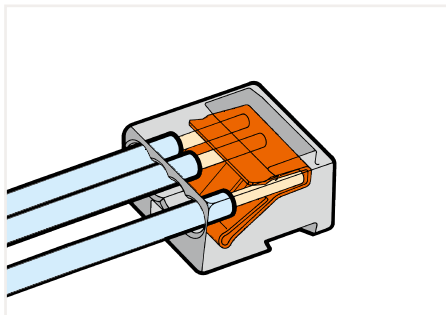

Typical application in a terminal box for burglar alarm – screw mount

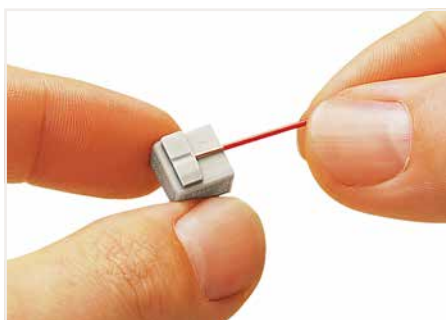

Strip solid conductors to 5 ... 6 mm (0.19 ... 0.23 inch).



DIN-35 rail-mount application (residential door bell)



Example of a residential intercom application

① Conductor range: Ø 0.6 ... 0.8 mm "s"; 22 ... 20 AWG;  
When using conductors of the same diameter, 0.5 mm (24 AWG) or 1 mm (18 AWG) diameters are also possible; Strip length: 5 ... 6 mm / 0.2 ... 0.24 inch

② Conductor range: Ø 0.4 ... 0.5 mm "s"; 26 ... 24 AWG  
③ 800 V = rated voltage  
8 kV = rated impulse voltage  
3 = pollution degree

Continuous operating temperature (max.): 105 °C  
Surrounding air temperature (max.): 60 °C

## WAGO COMPACT PUSH WIRE® Connectors for Junction Boxes – 2273 Series

### Description and Installation

2

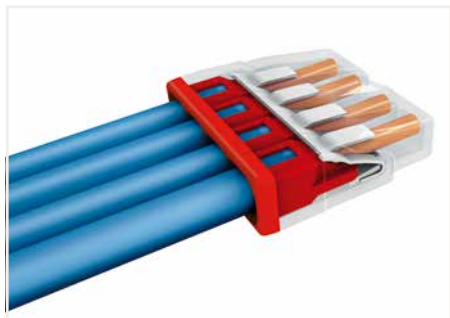

Strip solid conductor to 11 mm/0.43 inch (see marking).



Termination: Insert the stripped solid conductor until it hits the backstop.

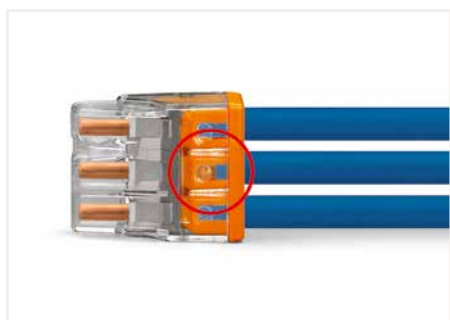

The transparent housing shows if conductors are fully inserted; within the colored base, a clear port shows if the conductor's strip length is correct. Conductors are correctly stripped if the clear port shows no bare conductor on the unprinted connector side. Picture shows center conductor with exceeded strip length.



Removal: Hold conductor to be removed and twist alternately left and right while pulling the connector.



Testing via test port opposite to conductor entry.

One single carrier can hold up to 24 clamping units in a very narrow space. Previously, this was only possible using rail-mount terminal blocks.

#### Advantages:

- Mount carrier onto DIN-35 rail or via screws – easily and quickly
- Accommodate three 2.5 mm<sup>2</sup> (12 AWG) 2273 Series Connectors in a single carrier
- Easily exchange connectors
- Large marking area for self-adhesive marking strips or for direct marking with permanent felt-tip pen

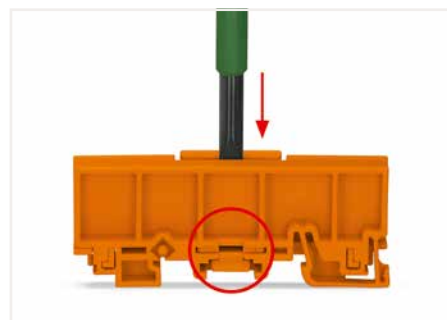

To adjust the mounting carrier, unlock the latch via operating tool (5.5 mm blade) and move the clamping slide to the required width by rotating the tool.



The mounting carrier is suitable for both connector widths.

#### PUSH WIRE® Connectors in Distribution Boxes

During distribution box retrofits or expansions, conductors often require extensions or additional clamping points. Individual PUSH WIRE® connectors (e.g., 2273 Series) are approved as interconnect components for building wiring applications per EN 60998. Application standards for building installation (e.g., Parts 510 and 520 from DIN VDE 0100) also place the following requirements on junction box connectors:

- They must be arranged so that operation, inspection, maintenance and access to the removable connectors is simplified.
- It must be possible to test them.
- Conductors connected from outside must be clearly and permanently assigned to their associated circuits.

These requirements cannot be met with PUSH WIRE® Connectors alone. However, when combined with WAGO's Mounting Carriers, the PUSH WIRE® Connectors clearly meet these requirements, making them comparable to rail-mount terminal blocks. Using PUSH WIRE® Connectors with mounting carriers in distribution boxes is accepted by testing authorities.

## WAGO COMPACT PUSH WIRE® Junction Box Connector for Solid Conductors – 2273 Series 2,5 mm<sup>2</sup>

Image	Description	Color	Item No.	PU	Dimensions (W x H x D)	Electrical Data
<b>2-wire connector</b>						
	Transparent housing; white cover	○ white	2273-202	1000	10 x 5,8 x 16,7 / 0,39 x 0,23 x 0,66 inch	450 V / 4 kV / 2 ①; I <sub>N</sub> 24 V
<b>3-wire connector</b>						
	Transparent housing; orange cover	● orange	2273-203	1000	14 x 5,8 x 16,7 / 0,55 x 0,23 x 0,66 inch	450 V / 4 kV / 2 ①; I <sub>N</sub> 24 V
<b>4-wire connector</b>						
	Transparent housing; red cover	● red	2273-204	1000	18 x 5,8 x 16,7 / 0,71 x 0,23 x 0,66 inch	450 V / 4 kV / 2 ①; I <sub>N</sub> 24 V
<b>5-wire connector</b>						
	Transparent housing; yellow cover	● yellow	2273-205	1000	22 x 5,8 x 16,7 / 0,87 x 0,23 x 0,66 inch	450 V / 4 kV / 2 ①; I <sub>N</sub> 24 V
<b>8-wire connector</b>						
	Transparent housing; light gray cover	○ light gray	2273-208	500	18 x 10,4 x 16,7 / 0,71 x 0,41 x 0,66 inch	450 V / 4 kV / 2 ①; I <sub>N</sub> 24 V
<b>Mounting carrier</b>						
	for single and double-row connectors	● orange	2273-500	10	18,5 x 21,5 x 72,5 mm / 0,73 x 0,85 x 2,85 inch	
<b>Accessories</b>						
	Syringe; contains 20 ml "Alu-Plus" Contact Paste		249-130	5		

2

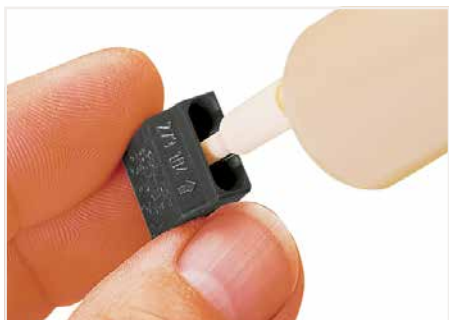

Push nozzle of the "Alu-Plus" syringe first into the circular entry and then into the square conductor entry hole of the WAGO Lighting Connector.



Press the plunger down until "Alu-Plus" has filled both entry holes.

**Note:** Not suitable for higher temperature applications!

Conductor range: 0.5 ... 2.5 mm<sup>2</sup> "s"; 20 ... 14 AWG;  
Strip length: 11 mm / 0.43 inch

① 450 V = rated voltage  
4 kV = rated impulse voltage  
2 = pollution degree

Continuous operating temperature (max.): 105 °C  
Surrounding air temperature (max.): 60 °C

# WAGO COMPACT PUSH WIRE® Junction Box Connectors – 2773 Series

## Description and Installation

2



**Advantages:**

- Convenient wiring via extremely compact design
- Push-in termination of up to eight solid and stranded conductors
- Conductor range: 0.75 ... 4 mm<sup>2</sup> "s" and 1.5 ... 4 mm<sup>2</sup> "st"
- Any combination of conductor sizes is possible
- PUSH WIRE® connection terminates solid ("s") copper conductors

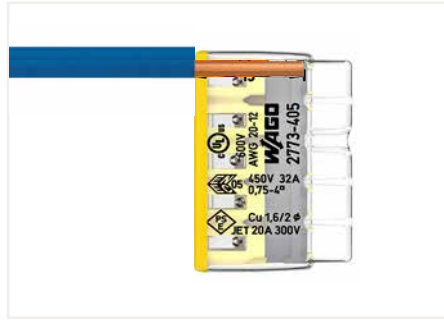

Strip solid or stranded conductor to 13 mm (0.51 inch).



Termination: Insert the stripped conductor until it hits the backstop.



The transparent housing shows if conductors are fully inserted; within the colored base, a clear port shows if the conductor's strip length is correct. Conductors are correctly stripped if the clear port shows no bare conductor on the unprinted connector side. Picture shows center conductor with exceeded strip length.



Removal: Hold solid conductor to be removed and twist alternately left and right while pulling the connector.



Testing via test port opposite to conductor entry.

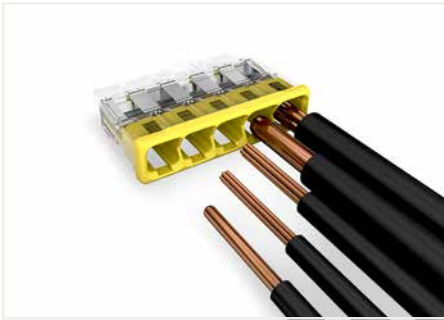

Solid and stranded conductors of different cross-sections can be securely connected.



Solid conductors are inserted into the connector by simply pushing them in.

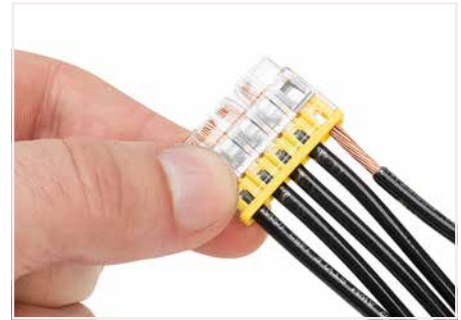

Stranded conductors are inserted into the connector by simply pushing them in.

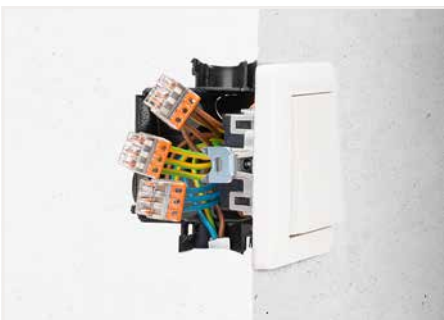

Thanks to their flat and compact design, these connectors are ideal for wiring in flush-mount switch boxes.



With six variants, always have the right connector.



The mounting carrier is suitable for both connector widths.



## WAGO COMPACT PUSH WIRE® Junction Box Connector – 2773 Series

### 4 mm<sup>2</sup>

Image	Description	Color	Item No.	PU	Dimensions (W x H x D)	Electrical Data
<b>2-wire connector</b>						
	Transparent housing; white cover	○ white	2773-402	1200	11,6 x 6,3 x 18,6 mm/ 0.46 x 0.25 x 0.73 inch	450/4 kV/2 ①; I <sub>N</sub> 32 A; 600 V, 20 A ②
<b>3-wire connector</b>						
	Transparent housing; orange cover	● orange	2773-403	1000	16,4 x 6,3 x 18,6 mm/ 0.65 x 0.25 x 0.73 inch	450/4 kV/2 ①; I <sub>N</sub> 32 A; 600 V, 20 A ②
<b>4-wire connector</b>						
	Transparent housing; red cover	● red	2773-404	800	21,2 x 6,3 x 18,6 mm/ 0.84 x 0.25 x 0.73 inch	450/4 kV/2 ①; I <sub>N</sub> 32 A; 600 V, 20 A ②
<b>5-wire connector</b>						
	Transparent housing; yellow cover	● yellow	2773-405	600	26 x 6,3 x 18,6 mm/ 1.02 x 0.25 x 0.73 inch	450/4 kV/2 ①; I <sub>N</sub> 32 A; 600 V, 20 A ②
<b>6-wire connector</b>						
	Transparent housing; gray cover	○ gray	2773-406	500	16,4 x 11,3 x 18,6 mm/ 0.65 x 0.45 x 0.73 inch	450/4 kV/2 ①; I <sub>N</sub> 32 A; 600 V, 20 A ②
<b>8-wire connector</b>						
	Transparent housing; light gray cover	○ light gray	2773-408	400	21,2 x 11,3 x 18,6 mm/ 0.84 x 0.45 x 0.73 inch	450/4 kV/2 ①; I <sub>N</sub> 32 A; 600 V, 20 A ②
<b>Mounting carrier</b>						
	Mounting carrier; for single- and double-row connectors	● orange	2773-500	10	18 x 23 x 84 mm/ 0.71 x 0.91 x 3.31 inch	

These COMPACT PUSH WIRE® Connectors for Junction Boxes are only available for the following countries: Australia, China, Japan, Norway, Sweden, South Africa, Taiwan, United Kingdom, USA

Conductor range: 0.75 ... 4 mm<sup>2</sup> "s"; 20 ... 12 AWG "s";  
1.6 ... 2 mm Ø "s"; 1.5 ... 4 mm<sup>2</sup> "st"; 18 ... 12 AWG "st";  
Strip length: 13 mm / 0.51 inch

Continuous operating temperature (max.): 150 °C  
Surrounding air temperature (max.): 85 °C

① 450 V = rated voltage  
4 kV = rated impulse voltage  
2 = pollution degree

## WAGO PUSH WIRE® Connectors for Junction Boxes – 773 Series

### Description and Installation

2

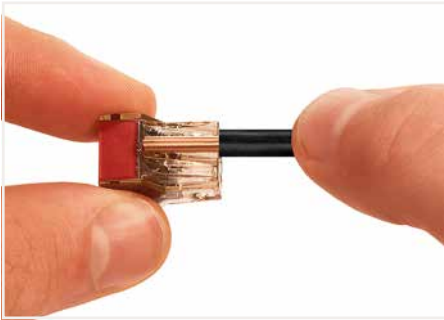

Strip a solid conductor to 12 mm (0.47 inch).



Termination: Insert stripped solid conductor until it hits the backstop.



Removal: Hold conductor to be removed and twist alternately left and right while pulling the connector.



Testing

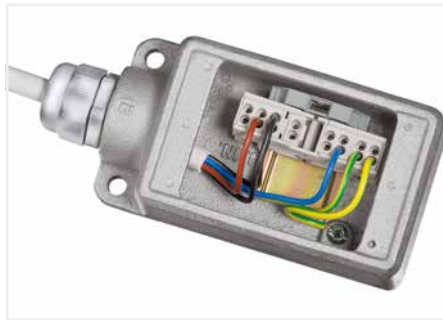

Wiring example in an Ex junction box



Wiring example in an Ex junction box

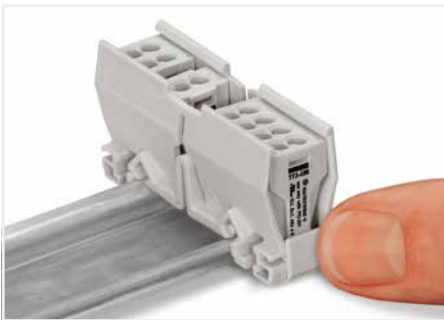

Use the cover as an end plate.



Snap the mounting carrier onto the DIN-rail.



Remove the mounting carrier from the DIN-rail.



A mounting carrier (see accessories) suits applications where the connectors must be marked and secured in position. The DIN-35 rail-mount carrier fits up to six connectors and can also be mounted on a flat surface using two screws. Using this connector carrier, a large range of wiring applications can be executed in distribution or junction boxes. To mention just a few: potential multiplication and changing from or to 6 mm<sup>2</sup> (10 AWG) conductor size.

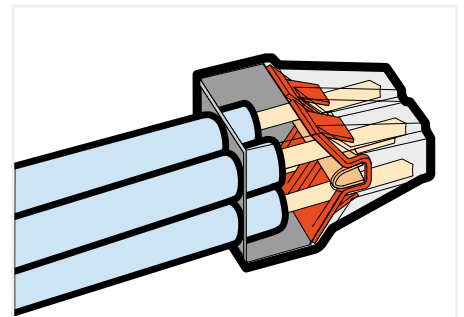

# WAGO PUSH WIRE® Connector for Junction Boxes; for solid and stranded conductors

## – 773 Series

### 2,5 / 4 / 6 mm<sup>2</sup>

Image	Description	Color	Item No.	PU	Dimensions (W x H x D)	Electrical Data
<b>PUSH WIRE® connector for junction boxes; for solid and stranded conductors; max. 2.5 mm<sup>2</sup> ①</b>						
	2 conductors; transparent housing; yellow cover	● yellow	773-102	1000	9,2 x 13,1 x 19,5 mm/ 0.36 x 0.52 x 0.77 inch	400/4 kV/2 ④; I <sub>n</sub> 24 A
	2 conductors; light gray housing; light gray cover	○ light gray ⑤	773-492 ⑤	1000		
	4 conductors; transparent housing; orange cover	● orange	773-104	1000	13 x 13,1 x 19,5 mm/ 0.51 x 0.52 x 0.79 inch	400/4 kV/2 ④; I <sub>n</sub> 24 A
	4 conductors; black housing; black cover	● black	773-504	1000		
	4 conductors; light gray housing; light gray cover	○ light gray ⑤	773-494 ⑤	1000		
	6 conductors; transparent housing; violet cover	● violet	773-106	500	18,8 x 13,1 x 19,5 mm/ 0.74 x 0.52 x 0.77 inch	400/4 kV/2 ④; I <sub>n</sub> 32 A
	6 conductors; light gray housing; light gray cover	○ light gray ⑤	773-496 ⑤	500		
	8 conductors; transparent housing; black cover	● black	773-108	500	24 x 13,1 x 19,5 mm/ 0.95 x 0.52 x 0.77 inch	400/4 kV/2 ④; I <sub>n</sub> 24 A
	8 conductors; light gray housing; light gray cover	○ light gray ⑤	773-498 ⑤	500		
<b>PUSH WIRE® connector for junction boxes; for solid conductors; max. 4 mm<sup>2</sup> ②</b>						
	2 conductors; transparent brown housing; white cover	○ white	773-602	1000	9,2 x 13,1 x 19,5 mm/ 0.36 x 0.52 x 0.77 inch	400/4 kV/2 ④; I <sub>n</sub> 32 A
	4 conductors; transparent brown housing; red cover	● red	773-604	1000		
	6 conductors; transparent brown housing; brown cover	● brown	773-606	500	18,8 x 13,1 x 19,5 mm/ 0.74 x 0.52 x 0.77 inch	
<b>PUSH WIRE® connector for junction boxes; for solid and stranded conductors; max. 6 mm<sup>2</sup> ③</b>						
	3 conductors; transparent housing; red cover	● red	773-173	500	25,6 x 14,2 x 20,1 mm/ 1 x 0.56 x 0.79 inch	400/4 kV/2 ④; I <sub>n</sub> 41 A
	3 conductors; light gray housing; light gray cover	○ light gray ⑤	773-493 ⑤	500		
<b>Mounting carrier</b>						
	Mounting carrier; for all 773 Series PUSH WIRE® Connectors for Junction Boxes	● orange	773-332	10	18 x 26 x 61 mm/ 0.71 x 1.02 x 2.4 inch	
	Mounting carrier; for Ex PUSH WIRE® junction box connectors	○ light gray ⑤	773-331	10	18 x 26 x 61 mm/ 0.71 x 1.02 x 2.4 inch	
<b>Accessories</b>						
	Syringe; contains 20 ml "Alu-Plus" Contact Paste		249-130	5		

① Conductor range: 0.75 ... 2.5 mm<sup>2</sup> "s"; 18 ... 12 AWG "s"; 1.5 ... 2.5 mm<sup>2</sup> "st"; 16 ... 12 AWG "st"; Strip length: 12 mm / 0.47 inch

② Conductor range: 1.5 ... 4 mm<sup>2</sup> "s"; Strip length: 12 mm / 0.47 inch

③ Conductor range: 2.5 ... 6 mm<sup>2</sup> "s+st"; 14 ... 10 AWG "s+st"; Strip length: 12 ... 13 mm / 0.47 ... 0.51 inch

④ 400 V = rated voltage  
4 kV = rated impulse voltage  
2 = pollution degree

⑤ Suitable for Ex e II applications  
Continuous operating temperature (max.): 105 °C  
Surrounding air temperature (max.): 60 °C

# WAGO Splicing Connector Set 887 Series

2

Description	Item No.	COMPACT Splicing Connector							Lighting Connector	
										
		2 wires; 4 mm <sup>2</sup> ; transparent	3 wires; 4 mm <sup>2</sup> ; transparent	5 wires; 4 mm <sup>2</sup> ; transparent	2 wires; 6 mm <sup>2</sup> ; transparent	3 wires; 6 mm <sup>2</sup> ; transparent	5 wires; 6 mm <sup>2</sup> ; transparent	Mounting carrier; orange	Mounting carrier; orange	2 wires; 2.5 mm <sup>2</sup> ; white
		221-412	221-413	221-415	221-612	221-613	221-615	221-500	221-510	224-112
L-BOXX Mini Set; 221, 2273, 773, 224, 243 Series	887-950	16	12	8						10
L-BOXX Mini; 221 Series	887-952	100	100	25				4		
L-BOXX Mini; 2273 Series	887-953									
L-BOXX Mini Set; 221, 2273 Series	887-955	75	50	25				1		
L-BOXX Mini; 221 Series; 4 mm <sup>2</sup> /6 mm <sup>2</sup>	887-957	75	50	25	40	30	15	1		
L-BOXX Mini; 221 Series; 4 mm <sup>2</sup> /6 mm <sup>2</sup>	887-959	100	100	25		30				
L-BOXX Mini; 221, 2273, 224 Series	887-960	20	15	10		5				15
Vario-T-BOXX Set; 221, 2273, 773, 224, 243 Series	887-912		50	25						100
L-BOXX 102 Set; 221, 2273, 773, 224, 243 Series	887-913	100	50	25				4		100
L-BOXX 102 Set; 221, 2273 Series	887-917	100	100	25				2		
L-BOXX 102 Set; 221 Series	887-918	100	250	50				10		
L-BOXX 102; 221 Series; 4 mm <sup>2</sup> /6 mm <sup>2</sup>	887-920	200	150	25	50	30	15	2	2	
L-BOXX 102; 221 Series; 4 mm <sup>2</sup> /6 mm <sup>2</sup>	887-921	100	250	25		30		10		

### WAGO's New Splicing Connector Sets

Available in the compact L-BOXX Mini, L-BOXX and Vario-T-BOXX

Ready for a broad range of industries, these convenient cases contain an assortment of proven WAGO Splicing Connectors to terminate a broad range of conductor types and cross-sections – tackle practically any challenge (e.g., maintenance, lab work and building development).

With the L-BOXX, the splicing connectors always remain properly sorted and at the ready when you need them. More than convenient storage for splicing connectors, this space-saving case is easy to store when the job is done.



Simply snap together



Practical case saves space



Always close at hand and always in the right place

# WAGO Splicing Connector Set 887 Series

MICRO PUSH WIRE® connector for junction boxes				PUSH WIRE® Connector for Junction Boxes		COMPACT PUSH WIRE® Connector for Junction Boxes					
											
4 wires; Ø 0.08 mm; dark gray	8 wires; Ø 0.08 mm; dark gray	4 wires; Ø 0.08 mm; red	Mounting carrier; orange	3 wires; 2.5 mm²; red	4 wires; 4 mm²; red	2 wires; 2.5 mm²; white	3 wires; 2.5 mm²; orange	4 wires; 2.5 mm²; red	5 wires; 2.5 mm²; yellow	8 wires; 2.5 mm²; light gray	Mounting carrier; orange
243-204	243-208	243-804	243-113	773-173	773-604	2273-202	2273-203	2273-204	2273-205	2273-208	2273-500
30	30			5			20	20		15	
						100	100	100	75	25	4
							100		75	25	1
						40	30	25	20	15	
100	50	100	10		100		100		100	50	
100	50			50			100		100	50	
						100	100	100	100	50	2

2



Vario-T-BOXX



L-BOXX



L-BOXX Mini



887-950







887-952



887-955



## WAGO Splicing Connector in a Resealable Blister Pack

### Product Overview

Image	Contents	Item No.	PU
<b>COMPACT Splicing Connector for All Conductor Types; 221 Series</b>			
	16 x 221-412	221-412/996-016	100
	12 x 221-413	221-413/996-012	100
	8 x 221-415	221-415/996-008	100
	10 x 221-612	221-612/996-010	100
	8 x 221-613	221-613/996-008	100
	6 x 221-615	221-615/996-006	100
<b>Field-Wiring Terminal Block; 224 Series</b>			
	15 x 224-101	224-101/996-015	100
	15 x 224-112	224-112/996-015	100
<b>MICRO PUSH WIRE® Connector for Junction Boxes; 243 Series</b>			
	5 x 243-204; 5 x 243-304; 5 x 243-504; 5 x 243-804	243-9294/996-020	100
<b>COMPACT PUSH WIRE® Junction Box Connector for Solid Conductors; 2273 Series</b>			
	40 x 2273-202	2273-202/996-040	100
	30 x 2273-203	2273-202/996-030	100
	20 x 2273-204	2273-204/996-020	100
	20 x 2273-205	2273-205/996-020	100
	10 x 2273-208	2273-208/996-010	100
<b>PUSH WIRE® Connector for Junction Boxes; 773 Series</b>			
	20 x 773-102	773-102/996-020	100
	10 x 773-104	773-104/996-010	100
	10 x 773-106	773-106/996-010	100
	10 x 773-108	773-108/996-010	100
	5 x 773-173	773-173/996-005	100
	4 x 773-332	773-332/996-004	100

Note on package contents:  
PU = 100 pcs ▶ 10 boxes of 10 blister packs each

## WAGO Gelbox; Moisture Protection for Splicing Connectors 207 Series

Image	Description	Color	Item No.	PU
	Gelbox; IPX8; 221/2273 Series; max. 4 mm <sup>2</sup> connectors; size 1	gray	207-1331	4
	Gelbox; IPX8; 221/2273 Series; max. 4 mm <sup>2</sup> connectors; size 2	gray	207-1332	4
	Gelbox; IPX8; 221/2273 Series; max. 4 mm <sup>2</sup> connectors; size 3	gray	207-1333	3
	Gelbox; IPX8; 221 Series; max. 6 mm <sup>2</sup> connectors; size 1	gray	207-1431	4
	Gelbox; IPX8; 221 Series; max. 6 mm <sup>2</sup> connectors; size 2	gray	207-1432	3
	Gelbox; IPX8; 221 Series; max. 6 mm <sup>2</sup> connectors; size 3	gray	207-1433	2

2

### Permitted combinations of splicing connectors and Gelbox:

Item No.	221-412	221-413	221-415	221-612	221-613	221-615	2273-202	2273-203	2273-204	2273-208
207-1331	1 x 	1 x 	–				2 x 	–	1 x 	1 x 
207-1332	2 x 	–	1 x 				3 x 	2 x 	–	1 x 
207-1333	3 x 	2 x 	–				4 x 	–	2 x 	2 x 
207-1431				1 x 	1 x 	–				
207-1432				2 x 	–	1 x 				
207-1433				3 x 	2 x 	–				

For other connectors/combinations, please contact factory.



Gelbox öffnen.



Verdrahtete Klemme in Gelbox einlegen.



Anwendungsbeispiel



Verrastung sicher verschließen.



Wiederzugänglich: Gelbox öffnen und Gel entfernen, umverdrahten mit neuen Komponenten.



Anwendungsbeispiel

### Anwendungshinweise:

- Niederspannung: Bei Niederspannungsanwendungen z. B. 230 V ist für eine doppelte Isolierung des Gesamtsystems, speziell der Aderleitungen, zu sorgen. Dies kann u. a. durch den Einsatz der Gelboxen in ein Gehäuse/eine Verbindungsdose gemäß EN 60670 erreicht werden.
- Kleinspannung: Bei Kleinspannungsanwendungen (z. B. SELV) ist eine Basisisolierung der elektrischen Leitung ausreichend. Die Basisisolierung der Leitung muss für den Einsatzzweck geeignet sein.
- Wiederzugänglichkeit: Die Gelboxen und Klemmen sind wiederzugänglich.
- Wiederverwendbarkeit: Die Gelboxen und verwendeten Klemmen dürfen nicht wiederverwendet werden, da die Dichtigkeit bei erneutem Einsatz nicht sichergestellt werden kann. Nach dem Öffnen die Leitung mit neuen Komponenten bestücken.

### Technische Daten:

- Spannungsbereich: siehe Klemmenspannung
- Bemessungsstrom: siehe Klemmenstrom
- Bemessungsstoßspannung: 2,5 kV

- Isolationswiderstand: 5 MΩ
- Dauergebrauchstemperatur max.: 105 °C
- Umgebungstemperatur max.: 85 °C

- Schutzklasse: IPX8
- Unbegrenzt lagerfähiges Gel, kein Gefahrstoff gemäß CLP

# picoMAX® Pluggable Connectors

## Description and Installation

3



Inserting a fine-stranded conductor into an unmated female connector via push-button.

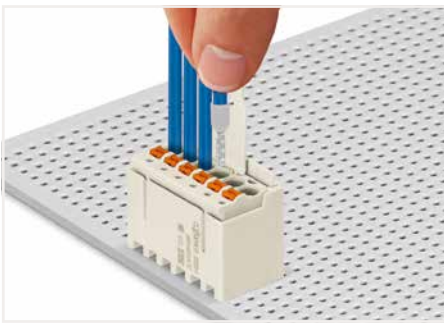

Inserting solid and ferruled conductors via push-in termination. For push-in termination, see notes on page 75.

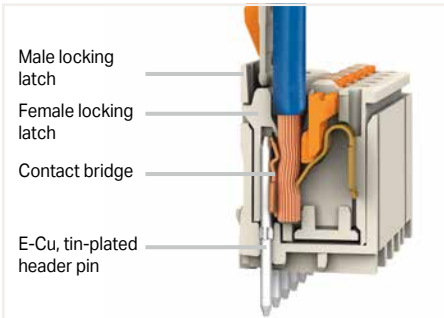
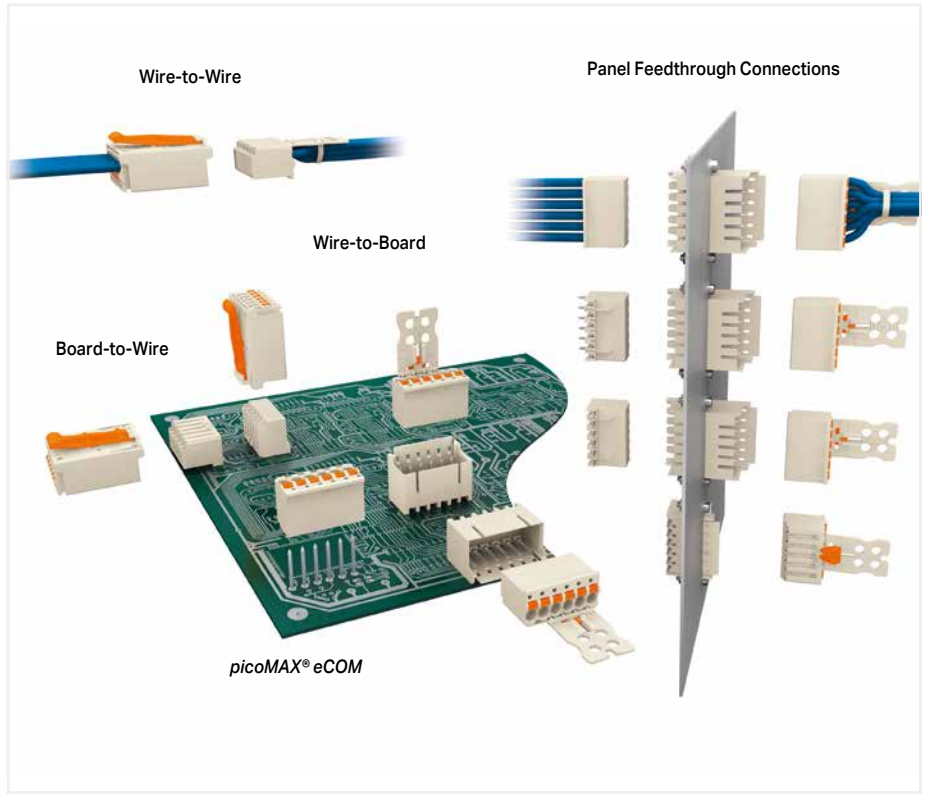

The locking latches on the male header and the female connector interlock to secure the connection.

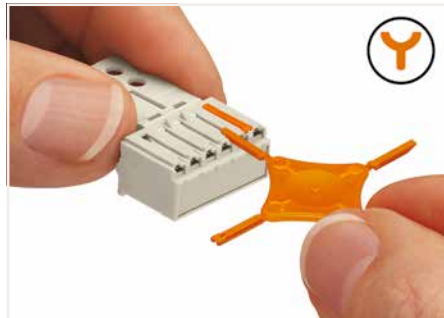

Coding a female connector (via 2091-1610 Coding Key Carrier and two keys for female connector, see symbol).

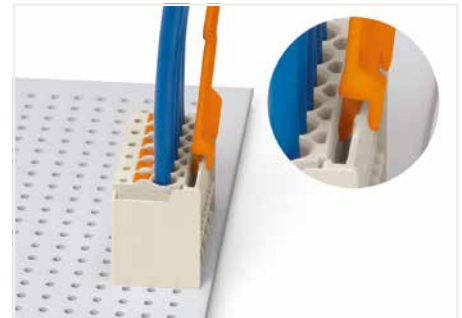

Disconnecting a female connector via unlocking tool: Plug unlocking tool into the male header's locking latch.

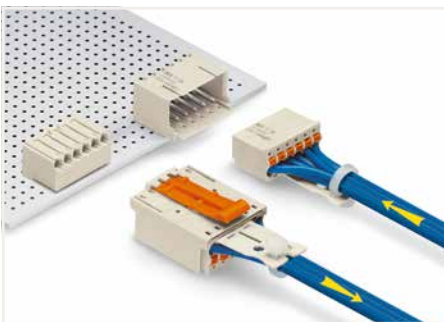

Easy-to-identify PCB inputs and outputs

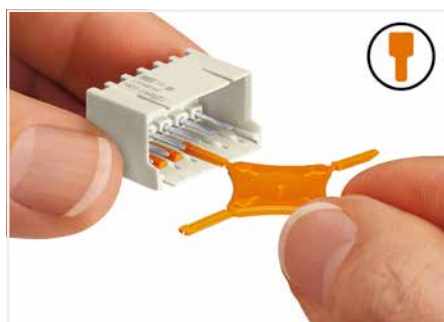

Coding a male header (via 2091-1610 Coding Key Carrier and two keys for male header, see symbol).

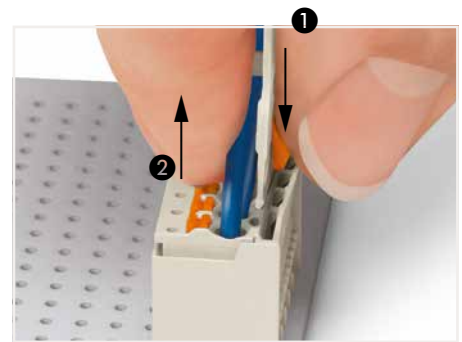



























Disconnecting female connector via sliding connector release:  
 1 Push down sliding connector release (gripping plate) to open the locking latch.  
 2 Pull out female connector from male header.



# picoMAX® Pluggable Connectors

## Combination Overview of Male and Female Connectors/Headers

		Male connector/header							
		Item No.	Pack. Unit	Item No.	Pack. Unit	Item No.	Pack. Unit	Item No.	Pack. Unit
		with straight solder pins; 2 ... 12 poles		with angled solder pins; 2 ... 12 poles		for wire connections; 2 ... 5 poles		for panel feedthrough connections; 2 ... 8 poles outside	
									inside, unlocked
		2091-1402	200	2091-1422	200	2091-1522/002-000	200	2091-1632/024-000	100
		2091-1412	100	2091-1432	100	2091-1528/002-000	50	2091-1638/024-000	50
		0.2 ... 2.5 mm² / 24 ... 12 AWG							
Female connector/header	for wire connections, with gripping plate and sliding connector release; 2 ... 12 poles							outside	inside
	0.2 ... 1.5 mm² / 24 ... 14 AWG								
	2091-1102/002-000	100							
	2091-1112/002-000	50							
	for wire connections, with gripping plate; 2 ... 12 poles							outside	inside
0.2 ... 1.5 mm² / 24 ... 14 AWG									
2091-1102	100								
2091-1112	50								
for wire connections; 2 ... 12 poles							outside	inside	
0.2 ... 1.5 mm² / 24 ... 14 AWG									
2091-1122	200								
2091-1132	100								
with straight solder pins; 2 ... 8 poles							outside	inside	
2091-1302	200								
2091-1308	100								
with angled solder pins; 2 ... 8 poles							outside	inside	
2091-1322	200								
2091-1328	100								

3



Disconnection: Open locking latches via unlocking tool (2092-1630).



Coding pin carrier for:  
3.5 mm pin spacing    2091-1610  
5/7.5 mm pin spacing    2092-1610



This combination of male and female connectors/headers is allowed.



This combination of male and female connectors/headers is not allowed.

All data refers to 3.5 mm (2.5 mm²) pin spacing.

Item numbers for other pin spacing dimensions:  
3.5 mm (2.5 mm²) pin spacing: 2091-1xxx (160 V / 10 A)  
5 mm (2.5 mm²) pin spacing: 2092-1xxx (320 V / 16 A)  
7.5 mm (2.5 mm²) pin spacing: 2092-3xxx (630 V / 16 A)

## *picoMAX*<sup>®</sup> eCOM Connectors Description and Installation

### 1. Place and solder the female headers as marked on the PCB.

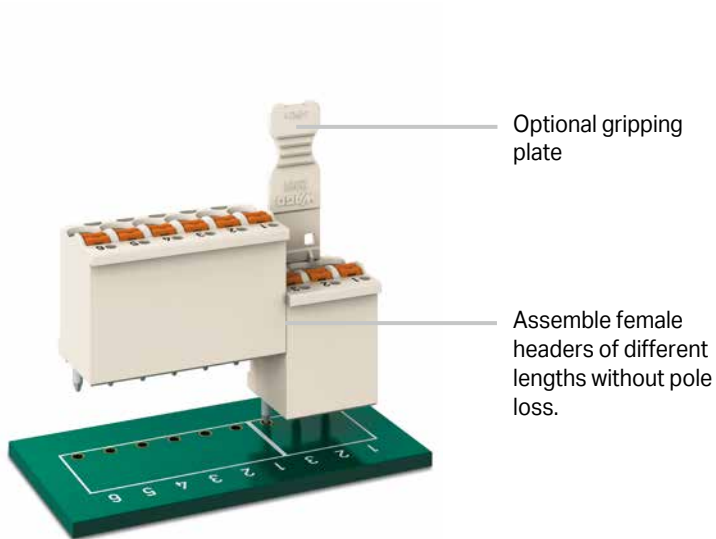

WAGO's *picoMAX*<sup>®</sup> eCOM Female Headers are delivered with solder pins so they can be directly soldered to a PCB and then wired just as PCB terminal blocks are. The Push-in CAGE CLAMP<sup>®</sup> S connection allows solid, stranded and fine-stranded conductors to be terminated via push-buttons. Solid and ferruled conductors are terminated by simply pushing them into unit. For simplified maintenance, the female headers can be removed without altering the wiring and then plugged onto the spare PCB.

### 2. Wired female headers

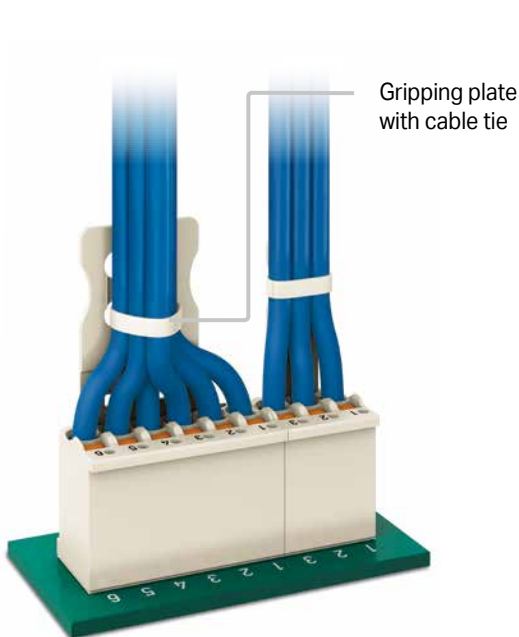

### 3. During maintenance

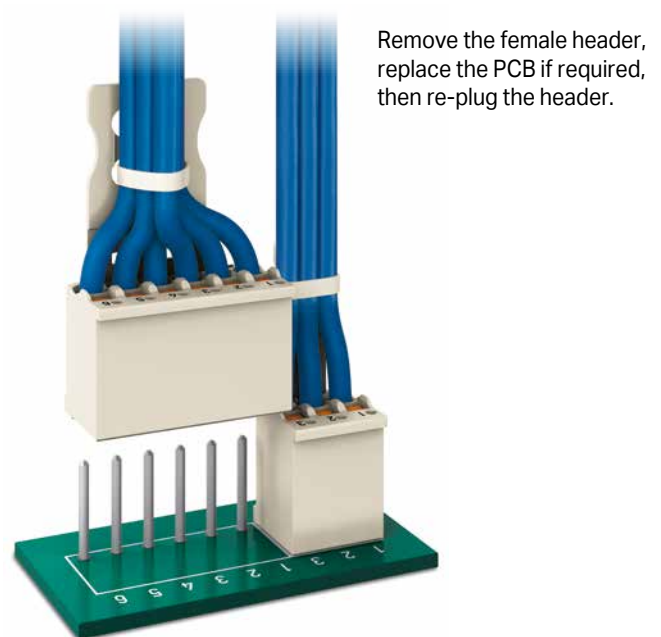

## picoMAX® eCOM Connectors

### System Overview for Female Headers with Wire Connection

#### picoMAX® eCOM Connectors; Female headers with wire connection

Pin spacing: 3.5 mm; 2 ... 12 poles

Pin spacing: 5 mm; 2 ... 12 poles

Pin spacing: 7.5 mm; 2 ... 5 poles

Item No.	Pack. Unit	Item No.	Pack. Unit	Item No.	Pack. Unit
----------	------------	----------	------------	----------	------------

with straight solder pins; without gripping plate

0.2 ... 1.5 mm<sup>2</sup> / 24 ... 14 AWG

2091-1172	200
2091-1182	100

0.2 ... 2.5 mm<sup>2</sup> / 24 ... 14 AWG

2092-1172	200
2092-1182	100

0.2 ... 2.5 mm<sup>2</sup> / 24 ... 14 AWG

2092-3172	100
2092-3175	100

with straight solder pins; with gripping plate

0.2 ... 1.5 mm<sup>2</sup> / 24 ... 14 AWG

2091-1152	100
2091-1162	50

0.2 ... 2.5 mm<sup>2</sup> / 24 ... 14 AWG

2092-1152	100
2092-1162	50

0.2 ... 2.5 mm<sup>2</sup> / 24 ... 14 AWG

2092-3152	100
2092-3155	100

with angled solder pins; without gripping plate

0.2 ... 1.5 mm<sup>2</sup> / 24 ... 14 AWG

2091-1372	200
2091-1382	100

0.2 ... 2.5 mm<sup>2</sup> / 24 ... 14 AWG

2092-1372	200
2092-1382	100

0.2 ... 2.5 mm<sup>2</sup> / 24 ... 14 AWG

2092-3372	100
2092-3375	100

with angled solder pins; with gripping plate

0.2 ... 1.5 mm<sup>2</sup> / 24 ... 14 AWG

2091-1352	100
2091-1362	50

0.2 ... 2.5 mm<sup>2</sup> / 24 ... 14 AWG

2092-1352	100
2092-1362	50

0.2 ... 2.5 mm<sup>2</sup> / 24 ... 14 AWG

2092-3352	100
2092-3355	100

Gripping plates for field assembly



2091-1600	100
2091-1603	100



2092-1600	100
2092-1603	100



2092-3600	100
2092-3603	100

Gripping plates with sliding connector release for field assembly



2091-1600/002-000	25
2091-1603/002-0	25



2092-1600/002-000	25
2092-1603/002-000	25



2092-3600/002-000	25
2092-3603/002-000	25

#### Accessories

Item No.	Pack. Unit	Item No.	Pack. Unit	Item No.	Pack. Unit
Operating tool with a partially insulated shaft; Type 1; (2.5 x 0.4) mm blade		Unlocking tool for female headers without gripping plate or sliding connector release		Test pin; 1 mm Ø; with solder connection for test cable	
210-719	1	2092-1630	25	735-500	1



# MCS – MULTI CONNECTION SYSTEM

## Description and Installation, e.g., for CAGE CLAMP® Connection

3

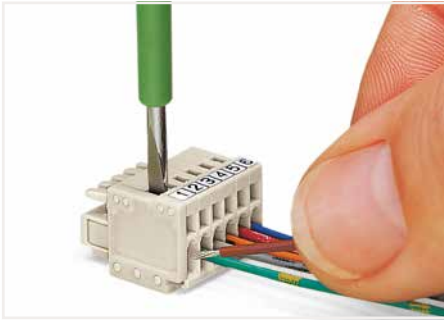

Inserting a conductor via (2.5 x 0.4) mm screwdriver. Operation perpendicular to conductor entry

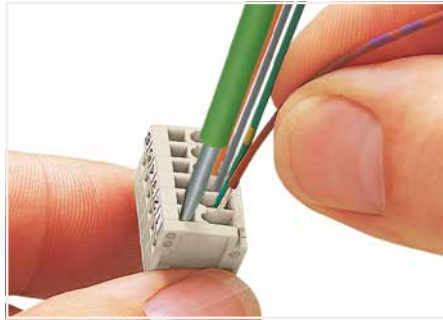

Inserting a conductor via (2.5 x 0.4) mm screwdriver. Operation parallel to conductor entry

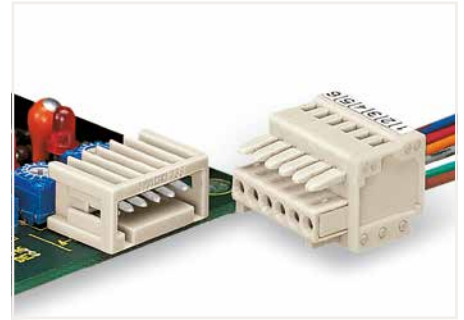

Male header and female connector – 100% protected against mismatching  
Only mating halves with the same pole number can be connected.

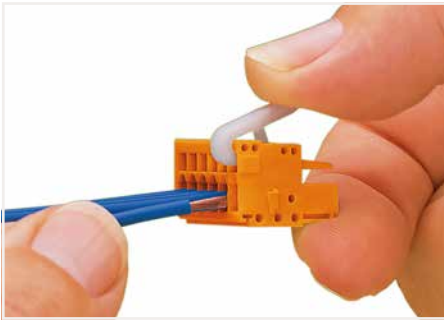

Inserting a conductor via push-button. (Item No. 734-230.)

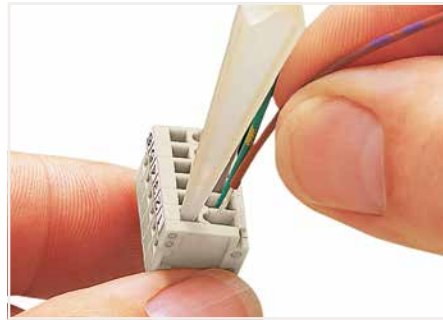

Inserting a conductor via operating tool. (Item No. 233-332.) Operation parallel to conductor entry



Testing via 1 mm Ø test pin (Item No. 735-500), touch contact.



Coding a male header – fitting coding key(s).

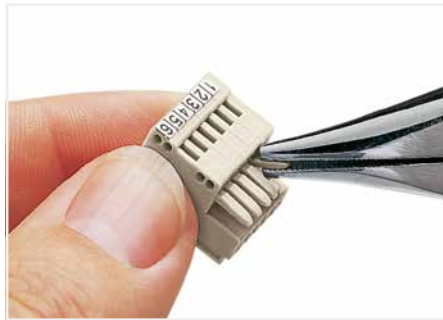

Coding a female connector – removing coding finger(s).



Factory marking or custom marking via self-adhesive strips



Prevents the insulation of smaller conductors from being inserted into the clamping unit.

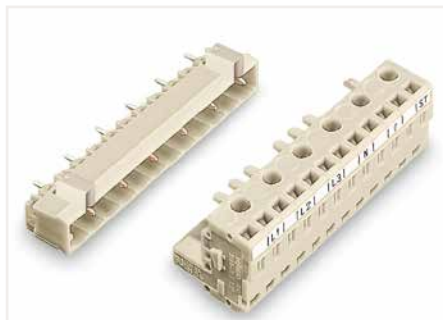

For 10 mm pin spacing, please contact factory.

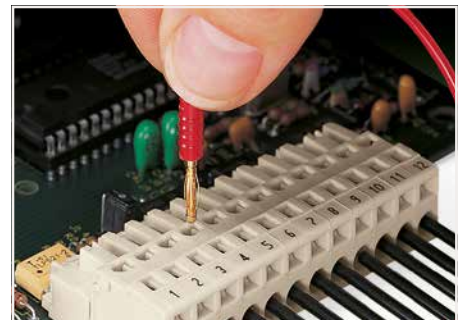

Testing with 2 mm or 2.3 mm Ø test plug.

# MCS – MULTI CONNECTION SYSTEM

## Product Overview by Pin Spacing

2.5 mm					
733 Series; MICRO; 100% Mismatching Protection; 160 V; 6 A					
Item No.	Pack. Unit	Item No.	Pack. Unit	Item No.	Pack. Unit
Male header; with straight solder pins; 2 ... 12 poles		Male header; with straight solder pins; 2 ... 12 poles		Female connector; 2 ... 12 poles	
○		●		○	
733-332	200	733-332/105-604	200	733-102	200
733-342	100	733-342/105-604	100	733-112	50
Male header; with angled solder pins; 2 ... 12 poles		Male header; with angled solder pins; 2 ... 12 poles		Female connector; with locking levers; 2 ... 12 poles	
○		●		○	
733-362	200	733-362/105-604	200	733-102/037-000	100
733-372	100	733-372/105-604	100	733-112/037-000	50

3.5 mm					
713 Series; MINI HD; 100% Mismatching Protection; 160 V; 10 A					
Item No.	Pack. Unit	Item No.	Pack. Unit	Item No.	Pack. Unit
Male header; with straight solder pins; 2 x 3 ... 2 x 18 poles		Male header; with angled solder pins; 2 x 3 ... 2 x 18 poles		Male header; with straight solder pins; 2 x 3 ... 2 x 18 poles	
●		●		●	
713-1403	100	713-1423	100	713-1403/105-000	100
713-1418	20	713-1438	20	713-1418/105-000	20
Male header; with straight solder pins and levers; 2 x 3 ... 2 x 18 poles		Male header; with angled solder pins and levers; 2 x 3 ... 2 x 18 poles		Male header; with straight solder pins and levers; 2 x 3 ... 2 x 18 poles	
●		●		●	
713-1403/037-000	50	713-1423/037-000	50	713-1403/116-000	50
713-1418/037-000	10	713-1438/037-000	10	713-1418/116-000	10
Male header; with straight solder pins and threaded flanges; 2 x 3 ... 2 x 18 poles		Male header; with angled solder pins and threaded flanges; 2 x 3 ... 2 x 18 poles		Male header; with straight solder pins and threaded flanges; 2 x 3 ... 2 x 18 poles	
●		●		●	
713-1403/107-000	50	713-1423/107-000	50	713-1403/117-000	50
713-1418/107-000	10	713-1438/107-000	10	713-1418/117-000	10
				Female connector; 2 x 3 ... 2 x 18 poles	
				●	
				0.08 ... 1.5 mm <sup>2</sup> / 28 ... 16 AWG	
				713-1103	100
				713-1118	20
				Female connector; with levers; 2 x 3 ... 2 x 18 poles	
				●	
				0.08 ... 1.5 mm <sup>2</sup> / 28 ... 16 AWG	
				713-1103/037-000	50
				713-1118/037-000	10
				Female connector; with threaded flanges; 2 x 3 ... 2 x 18 poles	
				●	
				0.08 ... 1.5 mm <sup>2</sup> / 28 ... 16 AWG	
				713-1103/107-000	50
				713-1118/107-000	10

3.5 mm					
714 Series; MINI SL; 160 V; 8 A					
Item No.	Pack. Unit	Item No.	Pack. Unit	Item No.	Pack. Unit
Male header; with straight solder pins; 2 ... 16 poles		Male header; with angled solder pins; 2 ... 16 poles		Female connector; 2 ... 16 poles	
●		●		●	
714-132	200	714-162	200	714-102	200
714-146	100	714-176	100	714-116	50
				0.2 ... 1.5 mm <sup>2</sup> / 24 ... 16 AWG	

**THR** Through-Hole Reflow Soldering

# MCS – MULTI CONNECTION SYSTEM

## Product Overview by Pin Spacing

3

3.5 mm 734/2734 Series; MINI; 100% Mismatching Protection									
Item No.	Pack. Unit	Item No.	Pack. Unit	Item No.	Pack. Unit	Item No.	Pack. Unit	Item No.	Pack. Unit
Male header; with straight solder pins; 2 ... 24 poles		Female header; with straight solder pins; 2 ... 24 poles		Female connector; with push-but- tons; 2 ... 24 poles		Male connector; 2 ... 24 poles		Combi strip; 2 ... 12 poles	
734-132	200	734-462	200	2734-102	200	734-302	200	734-362	100
734-154	50	734-484	25	2734-124	25	734-324	25	734-372	25
Male header; with angled solder pins; 2 ... 24 poles		Female header; with angled solder pins; 2 ... 24 poles		Female connector; with push-but- tons and with locking levers; 2 ... 24 poles		Male header; with mounting flanges; 2 ... 24 poles		Combi strip; with locking levers; 2 ... 12 poles	
734-162	200	734-532	200	2734-102/037-000	100	734-302/019-000	100	734-362/037-000	100
734-184	50	734-554	25	2734-124/037-000	10	734-324/019-000	10	734-372/037-000	25
Male header; with straight solder pins; 2 ... 16 poles		Female header; with straight solder pins and locking levers; 2 ... 24 poles		Female connector; with push-but- tons and mounting flanges; 2 ... 24 poles		Male connector; with snap-in mounting feet; 2 ... 24 poles		Combi strip; with snap-in mount- ing feet; 2 ... 12 poles	
734-132/105-604	200	734-462/037-000	100	2734-102/031-000	100	734-302/018-000	200	734-362/008-000	100
734-146/105-604	50	734-484/037-000	10	2734-124/031-000	10	734-324/018-000	25	734-372/008-000	25
Male header; with angled solder pins; 2 ... 16 poles		Female header; with angled solder pins and locking levers; 2 ... 24 poles		Female connector; with push-but- tons and screw flanges; 2 ... 24 poles		Male connector; with threaded flanges; 2 ... 24 poles			
734-162/105-604	200	734-532/037-000	100	2734-102/107-000	100	734-302/109-000	100		
734-176/105-604	50	734-554/037-000	10	2734-124/107-000	10	734-324/109-000	10		
Male header; with angled solder pins; 4 ... 24 poles				Female connector; 2 ... 24 poles					
734-402	100			734-102	200				
734-412	50			734-124	25				
Double-deck male header; with angled solder pins and support; 4 ... 24 poles				Female connector; with locking levers; 2 ... 24 poles					
734-402/001-000	100			734-102/037-000	100				
734-412/001-000	50			734-124/037-000	10				
Male header; with straight solder pins and threaded flanges; 2 ... 24 poles				Female connector; with snap-in mounting feet; 2 ... 24 poles					
734-132/108-000	200			734-102/008-000	200				
734-154/108-000	50			734-124/008-000	25				
Male header; with angled solder pins and threaded flanges; 2 ... 24 poles				Female connector; with screw flanges; 2 ... 24 poles					
734-162/108-000	200			734-102/107-000	100				
734-184/108-000	50			734-124/107-000	10				

# MCS – MULTI CONNECTION SYSTEM

## Product Overview by Pin Spacing

3.81 mm 734/2734 Series; MINI; 100% Mismatching Protection									
Item No.	Pack. Unit	Item No.	Pack. Unit	Item No.	Pack. Unit	Item No.	Pack. Unit	Item No.	Pack. Unit
Male header; with straight solder pins; 2 ... 20 poles		Female header; with straight solder pins; 2 ... 20 poles		Female connector; 2 ... 20 poles		Male connector; 2 ... 20 poles		Female connector; with push-but- tons; 2 ... 20 poles	
734-232	200	734-502	200	734-202	200	734-332	200	2734-202	200
734-250	50	734-520	25	734-220	25	734-350	25	2734-220	25
Male header; with angled solder pins; 2 ... 20 poles		Female header; with angled solder pins; 2 ... 20 poles		Female connector; with locking levers; 2 ... 20 poles		Male header; with mounting flanges; 2 ... 20 poles		Female connector; with push-but- tons and with locking levers; 2 ... 20 poles	
734-262	200	734-562	200	734-202/037-000	100	734-332/019-000	100	2734-202/037-000	100
734-280	50	734-580	25	734-220/037-000	10	734-350/019-000	10	2734-220/037-000	10
Male header; with straight solder pins; 2 ... 16 poles		Female header; with straight solder pins and locking levers; 2 ... 20 poles		Female connector; with snap-in mounting feet; 2 ... 20 poles		Male connector; with snap-in mounting feet; 2 ... 20 poles		Female connector; with push-but- tons and mounting flanges; 2 ... 20 poles	
734-232/105-604	200	734-502/037-000	100	734-202/008-000	200	734-332/018-000	200	2734-202/031-000	100
734-242/105-604	100	734-520/037-000	10	734-220/008-000	25	734-350/018-000	25	2734-220/031-000	10
Male header; with angled solder pins; 2 ... 16 poles		Female header; with angled solder pins and locking levers; 2 ... 20 poles							
734-262/105-604	200	734-562/037-000	100						
734-272/105-604	100	734-580/037-000	10						
Male header; with angled solder pins; 4 ... 24 poles									
734-432	100								
734-442	50								
Double-deck male header; with angled solder pins and support; 4 ... 24 poles									
734-432/001-000	100								
734-442/001-000	50								

# MCS – MULTI CONNECTION SYSTEM

## Product Overview by Pin Spacing

3

5 mm 721/722/2721 Series; MIDI; 100% Mismatching Protection; 320 V; 12 A (16 A)									
Item No.	Pack. Unit	Item No.	Pack. Unit	Item No.	Pack. Unit	Item No.	Pack. Unit	Item No.	Pack. Unit
Male header; with straight solder pins; 2 ... 20 poles		Female header; with straight solder pins; 2 ... 20 poles		Female connector; 2 ... 20 poles		Male connector; 2 ... 20 poles		Female connector; with push-buttons; 2 ... 20 poles	
721-132/001-000	200	722-132	100	0.08 ... 2.5 mm <sup>2</sup> / 28 ... 12 AWG	100	0.08 ... 2.5 mm <sup>2</sup> / 28 ... 12 AWG	100	0.2 ... 2.5 mm <sup>2</sup> / 24 ... 12 AWG	100
721-150/001-000	50	722-150	10	721-102/026-000	10	721-602	10	721-102/026-000	10
Male header; with angled solder pins; 2 ... 20 poles		Female header; with angled solder pins; 2 ... 20 poles		Female connector; with locking levers; 2 ... 20 poles		Male header; with mounting flanges; 2 ... 20 poles		Female connector; with push-buttons and with locking levers; 2 ... 20 poles	
721-432/001-000	200	722-232	100	0.08 ... 2.5 mm <sup>2</sup> / 28 ... 12 AWG	100	0.08 ... 2.5 mm <sup>2</sup> / 28 ... 12 AWG	100	0.2 ... 2.5 mm <sup>2</sup> / 24 ... 12 AWG	100
721-450/001-000	50	722-250	10	721-102/037-000	100	721-602/019-000	100	721-102/037-000	100
Male header; with straight solder pins; 16 A; 2 ... 20 poles		Female header; with straight solder pins and locking levers; 2 ... 20 poles		Female connector; with snap-in mounting feet; 2 ... 20 poles		Male connector; with snap-in mounting feet; 2 ... 20 poles		Female connector; with push-buttons and snap-in mounting feet; 2 ... 20 poles	
721-162/001-000	200	722-132/039-000	100	0.08 ... 2.5 mm <sup>2</sup> / 28 ... 12 AWG	100	0.08 ... 2.5 mm <sup>2</sup> / 28 ... 12 AWG	100	0.2 ... 2.5 mm <sup>2</sup> / 24 ... 12 AWG	100
721-180/001-000	50	722-150/039-000	10	721-102/008-000	100	721-602/018-000	100	721-102/008-000	100
Male header; with angled solder pins; 16 A; 2 ... 20 poles		Female header; with angled solder pins and locking levers; 2 ... 20 poles		Female connector; with mounting flanges; 2 ... 20 poles		Male connector; with snap-in flanges; 2 ... 20 poles		Female connector; with push-buttons and mounting flanges; 2 ... 20 poles	
721-462/001-000	200	722-232/039-000	100	0.08 ... 2.5 mm <sup>2</sup> / 28 ... 12 AWG	100	0.08 ... 2.5 mm <sup>2</sup> / 28 ... 12 AWG	100	0.2 ... 2.5 mm <sup>2</sup> / 24 ... 12 AWG	100
721-480/001-000	50	722-250/039-000	10	721-102/031-000	100	721-602/114-000	100	721-102/031-000	100
Male connector for rail-mount terminal blocks; 2 ... 20 poles		Female header; with straight solder pins and mounting flanges; 2 ... 20 poles		Angled female connector; with conductor entry in the same direction as latches; 2 ... 20 poles					
721-162/003-000	200	722-132/031-000	100	0.08 ... 2.5 mm <sup>2</sup> / 28 ... 12 AWG	100				
721-180/003-000	50	722-150/031-000	10	722-202/026-000	100				
		Female header; with angled solder pins and mounting flanges; 2 ... 20 poles		Angled female connector; with conductor entry opposite of latches; 2 ... 20 poles					
		722-232/031-000	100	0.08 ... 2.5 mm <sup>2</sup> / 28 ... 12 AWG	100				
		722-250/031-000	10	722-102/026-000	100				
				722-120/026-000	10				
Female connector for rail-mount terminal blocks; 2 ... 20 poles		Female header; with straight solder pins and spacers; 2 ... 20 poles		2-conductor female connector; 2 ... 16 poles				Female connector; with flanges for panel mounting; 2 ... 20 poles	
722-132/005-000	100	722-132/047-000	100	0.2 ... 2.5 mm <sup>2</sup> / 24 ... 12 AWG	100			0.08 ... 2.5 mm <sup>2</sup> / 28 ... 12 AWG	100
722-150/005-000	10	722-150/047-000	10	721-2102/026-000	100			721-302/031-000	100
				721-2116/026-000	25			721-320/031-000	10
Female connector; with locking levers for rail-mount terminal blocks; 2 ... 20 poles		Female header; with angled solder pins and spacers; 2 ... 20 poles		2-conductor female connector; with locking levers; 2 ... 16 poles				Female connector; with snap-in feet for panel mounting; 2 ... 20 poles	
722-132/005-000/039-000	100	722-232/047-000	100	0.2 ... 2.5 mm <sup>2</sup> / 24 ... 12 AWG	100			0.08 ... 2.5 mm <sup>2</sup> / 28 ... 12 AWG	100
722-150/005-000/039-000	10	722-250/047-000	10	721-2102/037-000	100			721-302/008-000	100
				721-2116/037-000	10			721-320/008-000	10



# MCS – MULTI CONNECTION SYSTEM

## Product Overview by Pin Spacing

5 mm 231/232/731/2231 Series; MIDI Classic; 320 V; 12 A									
Item No.	Pack. Unit	Item No.	Pack. Unit	Item No.	Pack. Unit	Item No.	Pack. Unit	Item No.	Pack. Unit
Male header; with straight solder pins; 2 ... 24 poles		Female header; with straight solder pins; 2 ... 24 poles		Female connector; 2 ... 24 poles		Male connector; 2 ... 24 poles		Female connector; with push-buttons; 2 ... 24 poles	
231-132/001-000	200	232-132	100	0.08 ... 2.5 mm <sup>2</sup> / 28 ... 12 AWG		0.08 ... 2.5 mm <sup>2</sup> / 28 ... 12 AWG		0.2 ... 2.5 mm <sup>2</sup> / 24 ... 12 AWG	
231-154/001-000	50	232-154	10	231-102/026-000	100	231-602	100	2231-102/026-000	100
231-432/001-000	200	232-232	100	231-124/026-000	10	231-624	10	2231-124/026-000	10
231-454/001-000	50	232-254	10	Female connector; with locking levers; 2 ... 24 poles		Male header; with mounting flanges; 2 ... 24 poles		Female connector; with push-buttons and with locking levers; 2 ... 24 poles	
Male header; with straight solder pins and mounting flanges; 2 ... 14 poles		Female header; with angled solder pins and locking levers; 2 ... 24 poles		0.08 ... 2.5 mm <sup>2</sup> / 28 ... 12 AWG		0.08 ... 2.5 mm <sup>2</sup> / 28 ... 12 AWG		0.2 ... 2.5 mm <sup>2</sup> / 24 ... 12 AWG	
231-132/040-000	200	232-232	100	231-102/037-000	100	231-602/019-000	100	2231-102/037-000	100
231-144/040-000	50	232-254	10	231-124/037-000	10	231-624/019-000	10	2231-124/037-000	10
Male header; with angled solder pins and mounting flanges; 2 ... 14 poles		Female header; with straight solder pins and locking levers; 2 ... 24 poles		Female connector; with snap-in mounting feet; 2 ... 24 poles		Male connector; with snap-in mounting feet; 2 ... 24 poles		Female connector; with push-buttons and snap-in mounting feet; 2 ... 24 poles	
231-432/040-000	200	232-132/039-000	100	0.08 ... 2.5 mm <sup>2</sup> / 28 ... 12 AWG		0.08 ... 2.5 mm <sup>2</sup> / 28 ... 12 AWG		0.2 ... 2.5 mm <sup>2</sup> / 24 ... 12 AWG	
231-444/040-000	50	232-154/039-000	10	231-102/008-000	100	231-602/018-000	100	2231-102/008-000	100
Male header; with straight solder pins; 2 ... 12 poles		Female header; with angled solder pins and locking levers; 2 ... 24 poles		231-124/008-000	10	231-624/018-000	10	2231-124/008-000	10
231-132/001-000	200	232-232/039-000	100	Female connector; with mounting flanges; 2 ... 24 poles		Male connector; with snap-in flanges; 2 ... 24 poles		Female connector; with push-buttons and mounting flanges; 2 ... 24 poles	
231-142/001-000	100	232-254/039-000	10	0.08 ... 2.5 mm <sup>2</sup> / 28 ... 12 AWG		0.08 ... 2.5 mm <sup>2</sup> / 28 ... 12 AWG		0.2 ... 2.5 mm <sup>2</sup> / 24 ... 12 AWG	
Male header; with angled solder pins; 2 ... 12 poles		Female header; with straight solder pins and mounting flanges; 2 ... 24 poles		231-102/031-000	100	231-602/114-000	50	2231-102/031-000	100
231-432/001-000	200	232-132/031-000	100	231-124/031-000	10	231-624/114-000	10	2231-124/031-000	10
231-442/001-000	100	232-154/031-000	10	Angled female connector; with conductor entry in the same direction as latches; 2 ... 24 poles		Double-pin male connector mounted on DIN-35 rail; 2 ... 24 poles		Female connector; with push-buttons and integrated end plate; 2 ... 24 poles	
Male header for double-deck assembly; 2 ... 16 poles		Female header; with straight solder pins and mounting flanges; 2 ... 24 poles		0.08 ... 2.5 mm <sup>2</sup> / 28 ... 12 AWG		232-502/007-000	100	2231-102/102-000	100
232-332	100	232-232/031-000	100	232-202/026-000	100	232-524/007-000	10	2231-124/102-000	10
232-346	25	232-254/031-000	10	232-224/026-000	10				
Male connector for rail-mount terminal blocks; 2 ... 20 poles		Female header; with angled solder pins and mounting flanges; 2 ... 24 poles		Angled female connector; with conductor entry opposite of latches; 2 ... 24 poles				Female connector; with mounting flanges for panel mounting; 2 ... 20 poles	
231-162/003-000	200	232-232/031-000	100	0.08 ... 2.5 mm <sup>2</sup> / 28 ... 12 AWG				0.08 ... 2.5 mm <sup>2</sup> / 28 ... 12 AWG	
231-180/003-000	50	232-254/031-000	10	232-102/026-000	100			731-502/031-000	100
				232-124/026-000	10			731-520/031-000	10
				2-conductor female connector; 2 ... 16 poles				Female connector; with snap-in feet for panel mounting; 2 ... 20 poles	
				0.2 ... 2.5 mm <sup>2</sup> / 24 ... 12 AWG				0.08 ... 2.5 mm <sup>2</sup> / 28 ... 12 AWG	
				231-2102/026-000	100			731-502/008-000	100
				231-2116/026-000	25			731-520/008-000	10
				2-conductor female connector; with locking levers; 2 ... 16 poles					
				0.2 ... 2.5 mm <sup>2</sup> / 24 ... 12 AWG					
				231-2102/037-000	100				
				231-2116/037-000	10				

# MCS – MULTI CONNECTION SYSTEM





























## Product Overview by Pin Spacing

3

5.08 mm									
231/232/731/2231 Series; MIDI Classic; 320 V; 12 A (16 A)									
Item No.	Pack. Unit	Item No.	Pack. Unit	Item No.	Pack. Unit	Item No.	Pack. Unit	Item No.	Pack. Unit
Male header; with straight solder pins; 2 ... 24 poles		Female header; with straight solder pins; 2 ... 24 poles		Female connector; 2 ... 24 poles		Male connector; 2 ... 24 poles		Female connector; with push-buttons; 2 ... 24 poles	
231-332/001-000	200	232-162	100	0.08 ... 2.5 mm <sup>2</sup> / 28 ... 12 AWG	231-302/026-000	100	0.08 ... 2.5 mm <sup>2</sup> / 28 ... 12 AWG	231-632	100
231-354/001-000	50	232-184	10	231-324/026-000	10	231-654	10	2231-302/026-000	10
Male header; with angled solder pins; 2 ... 24 poles		Female header; with angled solder pins; 2 ... 24 poles		Female connector; with locking levers; 2 ... 24 poles		Male header; with mounting flanges; 2 ... 24 poles		Female connector; with push-buttons and with locking levers; 2 ... 24 poles	
231-532/001-000	200	232-262	100	0.08 ... 2.5 mm <sup>2</sup> / 28 ... 12 AWG	231-302/037-000	100	0.08 ... 2.5 mm <sup>2</sup> / 28 ... 12 AWG	2231-302/037-000	100
231-554/001-000	50	232-284	10	231-324/037-000	10	231-654/019-000	10	2231-324/037-000	10
Male header; with straight solder pins; 16 A; 2 ... 24 poles		Female header; with straight solder pins and locking levers; 2 ... 24 poles		Female connector; with snap-in mounting feet; 2 ... 24 poles		Male connector; with snap-in mounting feet; 2 ... 24 poles		Female connector; with push-buttons and snap-in mounting feet; 2 ... 24 poles	
231-362/001-000	200	232-162/039-000	100	0.08 ... 2.5 mm <sup>2</sup> / 28 ... 12 AWG	231-302/008-000	100	0.08 ... 2.5 mm <sup>2</sup> / 28 ... 12 AWG	2231-302/008-000	100
231-384/001-000	50	232-184/039-000	10	231-324/008-000	10	231-654/018-000	10	2231-324/008-000	10
Male header; with angled solder pins; 16 A; 2 ... 24 poles		Female header; with angled solder pins and locking levers; 2 ... 24 poles		Female connector; with mounting flanges; 2 ... 24 poles		Male connector; with snap-in flanges; 2 ... 24 poles		Female connector; with push-buttons and mounting flanges; 2 ... 24 poles	
231-562/001-000	200	232-262/039-000	100	0.08 ... 2.5 mm <sup>2</sup> / 28 ... 12 AWG	231-302/031-000	100	0.08 ... 2.5 mm <sup>2</sup> / 28 ... 12 AWG	2231-302/031-000	100
231-584/001-000	50	232-284/039-000	10	231-324/031-000	10	231-654/114-000	10	2231-324/031-000	10
Male header for double-deck assembly; 2 ... 16 poles		Female header; with straight solder pins and mounting flanges; 2 ... 24 poles		2-conductor female connector; 2 ... 16 poles		Male connector; with snap-in flanges and threaded flanges; 2 ... 16 poles		Angled female connector; with conductor entry in the same direction as latches; 2 ... 24 poles	
232-362	100	232-162/031-000	100	0.2 ... 2.5 mm <sup>2</sup> / 24 ... 12 AWG	231-2302/026-000	100	0.08 ... 2.5 mm <sup>2</sup> / 28 ... 12 AWG	232-402/026-000	100
232-376	25	232-184/031-000	10	231-2316/026-000	25	231-646/129-000	10	232-424/026-000	10
Male header; with straight solder pins and threaded flanges; 2 ... 16 poles		Female header; with angled solder pins and mounting flanges; 2 ... 24 poles		2-conductor female connector; with locking levers; 2 ... 16 poles		Male connector; with threaded flanges; 2 ... 16 poles		Angled female connector; with conductor entry opposite of latches; 2 ... 24 poles	
231-332/108-000	200	232-262/031-000	100	0.2 ... 2.5 mm <sup>2</sup> / 24 ... 12 AWG	231-2302/037-000	100	0.08 ... 2.5 mm <sup>2</sup> / 28 ... 12 AWG	232-302/026-000	100
231-346/108-000	50	232-284/031-000	10	231-2316/037-000	10	231-646/109-000	10	232-324/026-000	10
Male header; with angled solder pins and threaded flanges; 2 ... 16 poles				2-conductor female connector; with screw flanges; 2 ... 16 poles		Double-pin male connector mounted on DIN-35 rail; 2 ... 24 poles			
231-532/108-000	200			0.2 ... 2.5 mm <sup>2</sup> / 24 ... 12 AWG	231-2302/107-000	100	232-532/007-000	100	
231-546/108-000	50			231-2316/107-000	10	232-554/007-000	10		
				Female connector; with screw flanges; 2 ... 16 poles				Female connector; with push-buttons and screw flanges; 2 ... 24 poles	
				0.08 ... 2.5 mm <sup>2</sup> / 28 ... 12 AWG	231-302/107-000	100		0.2 ... 2.5 mm <sup>2</sup> / 24 ... 12 AWG	2231-302/107-000
				231-316/107-000	10			2231-316/107-000	10

# MCS – MULTI CONNECTION SYSTEM

## Product Overview by Pin Spacing

7.5 mm 721/722/723/2721 Series; MIDI; 100% Mismatching Protection; 630 V; 12 A (16 A)									
Item No.	Pack. Unit	Item No.	Pack. Unit	Item No.	Pack. Unit	Item No.	Pack. Unit	Item No.	Pack. Unit
Male header; with straight solder pins; 2 ... 12 poles		Female header; with straight solder pins; 2 ... 12 poles		Female connector; 2 ... 12 poles		Male connector; 2 ... 12 poles		Female connector; with push-buttons; 2 ... 12 poles	
○		○		○		○		○	
721-232/001-000	200	722-732	100	721-202/026-000	100	723-602	100	2721-202/026-000	100
721-242/001-000	50	722-742	10	721-212/026-000	25	723-612	25	2721-212/026-000	25
Male header; with angled solder pins; 2 ... 12 poles		Female header; with angled solder pins; 2 ... 12 poles		Female connector; with locking levers; 2 ... 12 poles		Male header; with mounting flanges; 2 ... 12 poles		Female connector; with push-buttons and with locking levers; 2 ... 20 poles	
○		○		○		○		○	
721-832/001-000	200	722-832	100	721-202/037-000	50	723-602/019-000	100	2721-202/037-000	50
721-842/001-000	50	722-842	10	721-212/037-000	10	723-612/019-000	25	2721-212/037-000	10
Male header; with straight solder pins; 16 A; 2 ... 12 poles		Female header; with straight solder pins and locking levers; 2 ... 12 poles		Female connector; with snap-in mounting feet; 2 ... 12 poles		Male connector; with snap-in mounting feet; 2 ... 12 poles		Female connector; with push-buttons and snap-in mounting feet; 2 ... 12 poles	
○		○		○		○		○	
721-262/001-000	200	722-732/039-000	100	721-202/008-000	50	723-602/018-000	100	2721-202/008-000	100
721-272/001-000	50	722-742/039-000	10	721-212/008-000	10	723-612/018-000	25	2721-212/008-000	25
Male header; with angled solder pins; 16 A; 2 ... 12 poles		Female header; with angled solder pins and locking levers; 2 ... 12 poles		Female connector; with mounting flanges; 2 ... 12 poles		Male connector; with snap-in flanges; 2 ... 12 poles		Female connector; with push-buttons and mounting flanges; 4 ... 12 poles	
○		○		○		○		○	
721-862/001-000	200	722-832/039-000	100	721-202/031-000	50	723-602/114-000	100	2721-202/031-000	50
721-872/001-000	50	722-842/039-000	10	721-212/031-000	10	723-612/114-000	25	2721-212/031-000	10
		Female header; with straight solder pins and mounting flanges; 2 ... 12 poles		2-conductor female connector; 2 ... 16 poles					
		○		○					
		722-732/031-000	100	721-2202/026-000	100				
		722-742/031-000	10	721-2212/026-000	25				
		Female header; with angled solder pins and mounting flanges; 2 ... 12 poles		2-conductor female connector; with locking levers; 2 ... 16 poles					
		○		○					
		722-832/031-000	100	721-2202/037-000	100				
		722-842/031-000	10	721-2212/037-000	25				
		Female header; with straight solder pins and spacers; 2 ... 12 poles						Female connector; with flanges for panel mounting; 2 ... 12 poles	
		○						○	
		722-732/047-000	100					0.08 ... 2.5 mm <sup>2</sup> / 28 ... 12 AWG	
		722-742/047-000	10					721-332/031-000	50
								721-342/031-000	10
		Female header; with angled solder pins and spacers; 2 ... 12 poles						Female connector; with snap-in feet for panel mounting; 2 ... 12 poles	
		○						○	
		722-832/047-000	100					0.08 ... 2.5 mm <sup>2</sup> / 28 ... 12 AWG	
		722-842/047-000	10					721-332/008-000	100
								721-342/008-000	25

# MCS – MULTI CONNECTION SYSTEM

## Product Overview by Pin Spacing

3

7.5 mm 231/232/731/732/2231 Series; MIDI Classic; 100% Mismatching Protection; 630 V; 12 A (16 A)									
Item No.	Pack. Unit	Item No.	Pack. Unit	Item No.	Pack. Unit	Item No.	Pack. Unit	Item No.	Pack. Unit
Male header; with straight solder pins; 2 ... 16 poles		Female header; with straight solder pins; 2 ... 16 poles		Female connector; 2 ... 16 poles		Male connector; 2 ... 16 poles		Female connector; with push-buttons; 2 ... 16 poles	
231-232/001-000	200	232-732	100	0.08 ... 2.5 mm <sup>2</sup> / 28 ... 12 AWG	231-202/026-000	100	0.08 ... 2.5 mm <sup>2</sup> / 28 ... 12 AWG	731-602	100
231-246/001-000	50	232-746	10	231-216/026-000	10	731-616	10	2231-202/026-000	10
Male header; with angled solder pins; 2 ... 16 poles		Female header; with angled solder pins; 2 ... 16 poles		Female connector; with locking levers; 2 ... 16 poles		Male header; with mounting flanges; 2 ... 16 poles		Female connector; with push-buttons and with locking levers; 2 ... 16 poles	
231-832/001-000	200	232-832	100	0.08 ... 2.5 mm <sup>2</sup> / 28 ... 12 AWG	231-202/037-000	50	0.08 ... 2.5 mm <sup>2</sup> / 28 ... 12 AWG	731-602/019-000	100
231-846/001-000	50	232-846	10	231-216/037-000	10	731-616/019-000	10	2231-202/037-000	50
Male header; with straight solder pins; 16 A; 2 ... 16 poles		Female header; with straight solder pins and locking levers; 2 ... 16 poles		Female connector; with snap-in mounting feet; 2 ... 16 poles		Male connector; with snap-in mounting feet; 2 ... 16 poles		Female connector; with push-buttons and snap-in mounting feet; 2 ... 16 poles	
231-262/001-000	200	232-732/039-000	100	0.08 ... 2.5 mm <sup>2</sup> / 28 ... 12 AWG	231-202/008-000	100	0.08 ... 2.5 mm <sup>2</sup> / 28 ... 12 AWG	731-602/018-000	100
231-276/001-000	50	232-746/039-000	10	231-216/008-000	10	731-616/018-000	10	2231-202/008-000	100
Male header; with angled solder pins; 16 A; 2 ... 16 poles		Female header; with angled solder pins and locking levers; 2 ... 16 poles		Female connector; with mounting flanges; 2 ... 16 poles		Male connector; with snap-in flanges; 2 ... 16 poles		Female connector; with push-buttons and mounting flanges; 2 ... 16 poles	
231-862/001-000	200	232-832/039-000	100	0.08 ... 2.5 mm <sup>2</sup> / 28 ... 12 AWG	231-202/031-000	50	0.08 ... 2.5 mm <sup>2</sup> / 28 ... 12 AWG	731-602/114-000	50
231-876/001-000	50	232-846/039-000	10	231-216/031-000	10	731-616/114-000	10	2231-202/031-000	50
Male header; with straight solder pins; 2 ... 12 poles		Female header; with straight solder pins and mounting flanges; 2 ... 16 poles		2-conductor female connector; 2 ... 12 poles					
231-232/001-000/105-604	200	232-732/031-000	100	0.2 ... 2.5 mm <sup>2</sup> / 24 ... 12 AWG	231-2202/026-000	100			
231-242/001-000/105-604	50	232-746/031-000	10	231-2212/026-000	25				
Male header; with angled solder pins; 2 ... 12 poles		Female header; with angled solder pins and mounting flanges; 2 ... 16 poles		2-conductor female connector; with locking levers; 2 ... 12 poles		Double-pin male connector mounted on DIN-35 rail; 2 ... 12 poles			
231-832/001-000/105-604	200	232-832/031-000	100	0.2 ... 2.5 mm <sup>2</sup> / 24 ... 12 AWG	231-2202/037-000	100	232-562/007-000	50	
231-842/001-000/105-604	50	232-846/031-000	10	231-2212/037-000	25	232-572/007-000	10		
Male header; with straight solder pins; 16 A; 2 ... 12 poles		Female header; with straight solder pins and spacers; 2 ... 16 poles						Angled female connector; with mounting flanges; 2 ... 12 poles	
231-262/001-000/105-604	200	232-732/047-000	100					731-532/031-000	50
231-272/001-000/105-604	50	232-746/047-000	10					731-546/031-000	10
Male header; with angled solder pins; 16 A; 2 ... 12 poles		Female header; with angled solder pins and spacers; 2 ... 16 poles						Angled female connector; with snap-in mounting feet; 2 ... 12 poles	
231-862/001-000/105-604	200	232-832/047-000	100					731-532/008-000	100
231-872/001-000/105-604	50	232-846/047-000	10					731-546/008-000	10

# MCS – MULTI CONNECTION SYSTEM



















## Product Overview by Pin Spacing









7.62 mm 231/232/731/2231 Series; MIDI Classic; 100% Mismatching Protection; 630 V; 12 A (16 A)									
Item No.	Pack. Unit	Item No.	Pack. Unit	Item No.	Pack. Unit	Item No.	Pack. Unit	Item No.	Pack. Unit
Male header; with straight solder pins; 2 ... 12 poles		Female header; with straight solder pins; 2 ... 12 poles		Female connector; 2 ... 12 poles		Male connector; 2 ... 12 poles		Female connector; with push-buttons; 2 ... 12 poles	
0.08 ... 2.5 mm <sup>2</sup> / 28 ... 12 AWG		0.08 ... 2.5 mm <sup>2</sup> / 28 ... 12 AWG		0.08 ... 2.5 mm <sup>2</sup> / 28 ... 12 AWG		0.08 ... 2.5 mm <sup>2</sup> / 28 ... 12 AWG		0.2 ... 2.5 mm <sup>2</sup> / 24 ... 12 AWG	
231-732/001-000	200	232-762	100	231-702/026-000	100	731-632	50	2231-702/026-000	100
231-742/001-000	50	232-772	10	231-712/026-000	10	731-642	10	2231-712/026-000	10
Male header; with angled solder pins; 2 ... 12 poles		Female header; with angled solder pins; 2 ... 12 poles		Female connector; with locking levers; 2 ... 12 poles		Male header; with mounting flanges; 2 ... 12 poles		Female connector; with push-buttons and with locking levers; 2 ... 12 poles	
0.08 ... 2.5 mm <sup>2</sup> / 28 ... 12 AWG		0.08 ... 2.5 mm <sup>2</sup> / 28 ... 12 AWG		0.08 ... 2.5 mm <sup>2</sup> / 28 ... 12 AWG		0.08 ... 2.5 mm <sup>2</sup> / 28 ... 12 AWG		0.2 ... 2.5 mm <sup>2</sup> / 24 ... 12 AWG	
231-932/001-000	200	232-862	100	231-702/037-000	50	731-632/019-000	50	2231-702/037-000	50
231-942/001-000	50	232-872	10	231-712/037-000	10	731-642/019-000	10	2231-712/037-000	10
Male header; with straight solder pins; 16 A; 2 ... 12 poles		Female header; with straight solder pins and locking levers; 2 ... 12 poles		Female connector; with snap-in mounting feet; 2 ... 12 poles		Male connector; with snap-in mounting feet; 2 ... 12 poles		Female connector; with push-buttons and snap-in mounting feet; 2 ... 12 poles	
0.08 ... 2.5 mm <sup>2</sup> / 28 ... 12 AWG		0.08 ... 2.5 mm <sup>2</sup> / 28 ... 12 AWG		0.08 ... 2.5 mm <sup>2</sup> / 28 ... 12 AWG		0.08 ... 2.5 mm <sup>2</sup> / 28 ... 12 AWG		0.2 ... 2.5 mm <sup>2</sup> / 24 ... 12 AWG	
231-762/001-000	200	232-762/039-000	100	231-702/008-000	100	731-632/018-000	100	2231-702/008-000	100
231-772/001-000	50	232-772/039-000	10	231-712/008-000	10	731-642/018-000	10	2231-712/008-000	10
Male header; with angled solder pins; 16 A; 2 ... 12 poles		Female header; with angled solder pins and locking levers; 2 ... 12 poles		Female connector; with mounting flanges; 2 ... 12 poles		Male connector; with snap-in flanges; 2 ... 12 poles		Female connector; with push-buttons and mounting flanges; 2 ... 12 poles	
0.08 ... 2.5 mm <sup>2</sup> / 28 ... 12 AWG		0.08 ... 2.5 mm <sup>2</sup> / 28 ... 12 AWG		0.08 ... 2.5 mm <sup>2</sup> / 28 ... 12 AWG		0.08 ... 2.5 mm <sup>2</sup> / 28 ... 12 AWG		0.2 ... 2.5 mm <sup>2</sup> / 24 ... 12 AWG	
231-962/001-000	200	232-862/039-000	100	231-702/031-000	50	731-632/114-000	50	2231-702/031-000	50
231-972/001-000	50	232-872/039-000	10	231-712/031-000	10	731-646/114-000	10	2231-712/031-000	10
		Female header; with straight solder pins and mounting flanges; 2 ... 12 poles		2-conductor female connector; 2 ... 12 poles		Double-pin male connector mounted on DIN-35 rail; 2 ... 12 poles		Angled female connector; with conductor entry opposite of latches; 2 ... 12 poles	
		0.2 ... 2.5 mm <sup>2</sup> / 24 ... 12 AWG		0.2 ... 2.5 mm <sup>2</sup> / 24 ... 12 AWG		0.08 ... 2.5 mm <sup>2</sup> / 28 ... 12 AWG		0.08 ... 2.5 mm <sup>2</sup> / 28 ... 12 AWG	
		232-762/031-000	100	231-2702/026-000	100	232-582/007-000	50	732-122/026-000	100
		232-772/031-000	10	231-2712/026-000	25	232-592/007-000	10	732-132/026-000	25

# MCS – MULTI CONNECTION SYSTEM

## Product Overview by Pin Spacing

3

7.62 mm									
831 Series; MAXI 6; 100% Mismatching Protection; 1000 V; 41 A									
Item No.	Pack. Unit	Item No.	Pack. Unit	Item No.	Pack. Unit	Item No.	Pack. Unit		
Male header; with straight solder pins; 2 ... 9 poles		Female connector; with lever; 2 ... 9 poles		Female connector; 2 ... 9 poles		Male connector; with lever; 2 ... 9 poles		Male connector; with lever; with integrated mounting adapter for DIN-35 rail; 2 ... 9 poles	
○		○		○		○		○	
831-3602	48	831-1102	48	831-3102	48	831-1202	48	831-1202/306-000	12
831-3609	12	831-1109	12	831-3109	12	831-1206	12	831-1209/306-000	6
Male header; with solder pins angled downwards; 2 ... 9 poles		Female connector; with lever; with lateral locking levers; 2 ... 9 poles		Female connector; with locking levers; 2 ... 9 poles		Male connector; 2 ... 9 poles		Male connector; with integrated mounting adapter for DIN-35 rail; 2 ... 9 poles	
○		○		○		○		○	
831-3622	48	831-1102/038-000	48	831-3102/037-000	48	831-3202	48	831-3202/007-000	48
831-3629	12	831-1109/038-000	12	831-3109/037-000	12	831-3209	12	831-3209/007-000	12
Male header; with solder pins angled upwards; 2 ... 9 poles		Female connector; with lever; with center locking lever; 2 ... 9 poles		Female connector; with screw flanges; 2 ... 9 poles		Male connector; with threaded flanges; 2 ... 9 poles		Female connector; with lever; with integrated mounting adapter for DIN-35 rail; 2 ... 9 poles	
○		○		○		○		○	
831-3642	48	831-1102/322-000	48	831-3102/107-000	24	831-3202/109-000	24	831-1102/306-000	12
831-3649	12	831-1109/322-000	12	831-3109/107-000	12	831-3209/109-000	12	831-1109/306-000	6
		Female header; with straight solder pins; 2 ... 9 poles		Female header; with solder pins angled downwards; 2 ... 9 poles		Male header; with straight solder pins; with threaded flanges; 2 ... 9 poles		Male header; with solder pins angled downwards; with threaded flanges; 2 ... 9 poles	
		○		○		○		○	
		831-3502	48	831-3522	48	831-3602/108-000	48	831-3622/108-000	48
		831-3509	12	831-3529	12	831-3609/108-000	12	831-3622/108-000	12

10.16 mm									
832 Series; MAXI 16; 100% Mismatching Protection; 1000 V; 41 A									
Item No.	Pack. Unit	Item No.	Pack. Unit	Item No.	Pack. Unit	Item No.	Pack. Unit		
Male header; with straight solder pins; 2 ... 6 poles				Female connector; with lever; 2 ... 6 poles		Male connector; with lever; 2 ... 6 poles		Male connector; with lever; with integrated mounting adapter for DIN-35 rail; 2 ... 6 poles	
○				○		○		○	
832-3602	50			832-1102	50	832-1202	50	832-1202/306-000	10
832-3606	10			832-1106	10	832-1206	10	832-1206/306-000	5
Male header; with solder pins angled downwards; 2 ... 6 poles				Female connector; with lever; with lateral locking levers; 2 ... 6 poles				Female connector; with lever; with integrated mounting adapter for DIN-35 rail; 2 ... 6 poles	
○				○				○	
832-3622	50			832-1102/037-000	50			832-1102/306-000	10
832-3626	10			832-1106/037-000	10			832-1106/306-000	5
Male header; with solder pins angled upwards; 2 ... 6 poles				Female connector; with lever; with center locking lever; 2 ... 6 poles					
○				○					
832-3642	50			832-1102/322-000	20				
832-3646	10			832-1106/322-000	5				

# MCS – MULTI CONNECTION SYSTEM

## Accessories

Snap-on type strain relief housing; for female/male connectors with CAGE CLAMP® connection

for 734 Series 3.5 mm pin spacing Pin spacing: 3.81 mm for 231 and 721 Series Pin spacing: 5 mm Pin spacing: 5.08 mm for 231, 721 and 731 Series Pin spacing: 7.5 mm Pin spacing: 7.62 mm



Pole No.	Color	Item No.	PU	Color	Item No.	PU	Color	Item No.	PU	Color	Item No.	PU	Color	Item No.	PU	Color	Item No.	PU
2	○	734-602	50	●	734-632	50	○	232-602	25	●	232-632	25	○	232-662	25	●	232-682	25
3	○	734-603	25	●	734-633	25	○	232-603	25	●	232-633	25	○	232-663	25	●	232-683	25
4	○	734-604	25	●	734-634	25	○	232-604	25	●	232-634	25	○	232-664	25	●	232-684	25
5	○	734-605	25	●	734-635	25	○	232-605	25	●	232-635	25	○	232-665	25	●	232-685	25
6	○	734-606	25	●	734-636	25	○	232-606	25	●	232-636	25						
7	○	734-607	25				○	232-607	25	●	232-637	25	○	232-667	25	●	232-687	25
8	○	734-608	25	●	734-638	25	○	232-608	25	●	232-638	25						
9	○	734-609	25	●	734-639	25	○	232-609	25	●	232-639	25						
10	○	734-610	25	●	734-640	25	○	232-610	25	●	232-640	25	○	232-670	25			
11	○	734-611	25															
12	○	734-612	25	●	734-642	25	○	232-612	25	●	232-642	25						
16				●						●	232-646	25						

Note: Only factory gluing possible!

Accessories; item-specific

Description:	Item No.	Pack. Unit
Cable clamp; for strain relief; 4 to 6 poles	209-177	25
Cable clamp; for strain relief; 7 or more poles	209-174	25
Mounting screw; for cable clamp; 4 to 6 poles	209-176	50
Mounting screw; for cable clamp; 7 or more poles	209-173	50

Strain relief plate; push-in type; for female connectors



Pin spacing: 2.5 mm									Pin spacing: 3.5 / 3.81 mm								
Pole No.	Width	Color	Item No.	Color	Item No.	Color	Item No.	PU	Pole No.	Width	Color	Item No.	Color	Item No.	Color	Item No.	PU
2 ... 4	6 mm	○	734-127	●	734-327	●	734-227	25	2 ... 3	6 mm	○	734-127	●	734-327	●	734-227	25
5 ... 9	12.5 mm	○	734-128	●	734-328	●	734-228	25	4 ... 8	12.5 mm	○	734-128	●	734-328	●	734-228	25
10 ... 12	25 mm	○	734-129	●	734-329	●	734-229	25	9 ... 12	25 mm	○	734-129	●	734-329	●	734-229	25
									13 ... 16	35 mm	○	734-126	●	734-326	●	734-226	25
									17 ... max.	55 mm	○	734-426	●	734-430	●	734-428	25

Pin spacing: 5 / 5.08 mm									Pin spacing: 7.5 / 7.62 mm								
Pole No.	Width	Color	Item No.	Color	Item No.	Color	Item No.	PU	Pole No.	Width	Color	Item No.	Color	Item No.	Color	Item No.	PU
2	6 mm	○	734-127	●	734-327	●	734-227	25	2	6 mm	○	734-127	●	734-327	●	734-227	25
3 ... 4	12.5 mm	○	734-128	●	734-328	●	734-228	25	2 ... 3	12.5 mm	○	734-128	●	734-328	●	734-228	25
5 ... 7	25 mm	○	734-129	●	734-329	●	734-229	25	4 ... 6	25 mm	○	734-129	●	734-329	●	734-229	25
8 ... 11	35 mm	○	734-126	●	734-326	●	734-226	25	7 ... 9	35 mm	○	734-126	●	734-326	●	734-226	25
12 ... 16	55 mm	○	734-426	●	734-430	●	734-428	25	10 ... 12	55 mm	○	734-426	●	734-430	●	734-428	25
17 ... 24	75 mm	○	734-427	●	734-431	●	734-429	25	13 ... 16	75 mm	○	734-427	●	734-431	●	734-429	25

Strain relief plate; push-in type; for male/female connectors with Push-in CAGE CLAMP® connection

Strain relief plate; snap-in type; for male/female connectors with Push-in CAGE CLAMP® connection

Strain relief plate; with strain relief plate; snap-in type; for male/female connectors with Push-in CAGE CLAMP® connection



Pin spacing: 7.62 mm					Pin spacing: 10.16 mm									
Pole No.	Width	Color	Item No.	PU	Pole No.	Width	Color	Item No.	PU	Pole No.	Width	Color	Item No.	PU
2 ... 3	15 mm	○	831-503	25	2	20.2 mm	○	832-532	25	2	20.2 mm	●	832-542	25
4 ... 6	30 mm	○	831-505	25	3	30.4 mm	○	832-533	25	3	30.4 mm	●	832-543	25
7 ... 9	51 mm	○	831-506	25	4	40.6 mm	○	832-534	25	4	40.6 mm	●	832-544	25
5	50.8 mm	○	832-535	25	5	50.8 mm	○	832-535	25	5	50.8 mm	●	832-545	25

For additional strain relief plates (e.g., factory-assembled, for male and female connectors with CAGE CLAMP® and Push-in CAGE CLAMP® connections), see Full Line Catalog, Volume 2.

# MCS – MULTI CONNECTION SYSTEM

## Accessories

3













Image	Description:	Item No.	Pack. Unit
	Test plug; with 500 mm cable		
	<input checked="" type="radio"/> 2 mm Ø	210-136	50
	<input checked="" type="radio"/> 2.3 mm Ø	210-137	50
	Test plug adapter; for female connectors for 5 and 5.08 mm pin spacing	231-661	100
	for 7.5 and 7.62 mm pin spacing	231-662	100
	Mounting adapter		
	<input checked="" type="radio"/> gray	231-193	100
	<input checked="" type="radio"/> orange	231-393	100
	Screw with nut; M2x12; for locking device	231-195	200
	<input checked="" type="radio"/> Multi mounting adapter; for male and female connectors with snap-in mounting feet	209-148	25
	<input checked="" type="radio"/> Mounting adapter; can be used as an end stop; 6.5 mm wide	209-137	25
	<input type="radio"/> Mounting adapter; for MCS MAXI	831-137	48
	<input type="radio"/> Mounting adapter; for MCS MAXI 6 male and female connectors with levers	831-1032	12
	<input type="radio"/> Mounting adapter; for MCS MAXI 16 male and female connectors with levers	832-1032	10
	<input type="radio"/> Snap-in frame for MCS MAXI 6 male connectors		
	<input type="radio"/> 2-pole; 45.84 mm wide	831-302	48
	<input type="radio"/> 3-pole; 53.46 mm wide	831-303	48
	<input type="radio"/> 4-pole; 61.08 mm wide	831-304	24
	<input type="radio"/> 5-pole; 68.7 mm wide	831-305	12
	<input type="radio"/> Locking device for snap-in frame	831-321	100
	Locking lever; for MCS MAXI 16; snap-in type		
	<input checked="" type="radio"/> 2/4/6 poles	832-522	60
	<input checked="" type="radio"/> 3/5 poles	832-523	40
	<input type="radio"/> Separator; for group formation	231-500	100
	Lockout cap; for covering unused clamping units		
	<input checked="" type="radio"/> gray	231-668	100
	<input checked="" type="radio"/> orange	231-669	100

Image	734 Series				231 / 721 / 722 Series					
	3.5 mm pin spacing				Pin spacing: 5 mm			Pin spacing: 7.5 mm		
	Color	Item No.	Pack. Unit	Color	Item No.	Pack. Unit	Color	Item No.	Pack. Unit	
<b>Coding key for male headers</b>										
	<input type="radio"/>	734-130	100	<input type="radio"/>	231-129	100	<input type="radio"/>	231-130	100	
	<input checked="" type="radio"/>	734-159	100	<input type="radio"/>	231-160	100				
	<input type="radio"/>	734-400	100							
<b>Insulation stop</b>										
	<input type="radio"/>	734-671	200	<input type="radio"/>	231-670	200	<input type="radio"/>	231-673	200	
				<input type="radio"/>	231-671	200	<input type="radio"/>	231-674	200	
				<input checked="" type="radio"/>	231-672	200	<input checked="" type="radio"/>	231-675	200	



# MCS – MULTI CONNECTION SYSTEM

## Accessories



Image	Description:	Item No.	Pack. Unit
	Operating tool with a partially insulated shaft		
	Type 1, (2.5 x 0.4) mm blade	210-719	1
	Type 2, (3.5 x 0.5) mm blade,	210-720	1
	Operating tool; for female and male connectors with CAGE CLAMP® connections		
	● MCS Midi & MINI	210-250	1
	● MCS MINI & MICRO	210-251	1
	Marking strip; DIN A4 sheet with 100 self-adhesive strips		
	Pin spacing: 2.5 mm; 1 ... 16 (400x)	210-331/250-202	
	Pin spacing: 3.5 mm; 1 ... 16 (240x)	210-332/350-202	
	Pin spacing: 3.81 mm; 1 ... 16 (160x)	210-332/381-202	
	Pin spacing: 5 mm; 1 ... 12 (300x)	210-331/500-103	
	Pin spacing: 5.08 mm; 1 ... 16 (200x)	210-331/508-103	
	Pin spacing: 7.5 mm; 1 ... 16 (100x)	210-331/750-202	
	Pin spacing: 7.62 mm; 1 ... 16 (100x)	210-331/762-202	



Image	733 Series			734 Series			231 / 721 / 722 Series					
	Pin spacing: 2.5 mm			3.5 mm pin spacing			Pin spacing: 5 mm			Pin spacing: 7.5 mm		
	Color	Item No.	Pack. Unit	Color	Item No.	Pack. Unit	Color	Item No.	Pack. Unit	Color	Item No.	Pack. Unit
	○	733-130	25	○	734-230	25	○	231-131	25	○	231-131	25
	●	733-191	25	●	734-191	25	●	231-291	25	●	231-291	25

Image	Operating tool											
	Color	Item No.	Pack. Unit	Color	Item No.	Pack. Unit	Color	Item No.	Pack. Unit	Color	Item No.	Pack. Unit
	○	233-332	25	○	734-190	25	○	231-159	25	○	231-159	25
	●	233-331	25	●	734-231	25	●	231-231	25	●	231-231	25



Inserting a conductor into CAGE CLAMP® unit via operating tool (210-250).

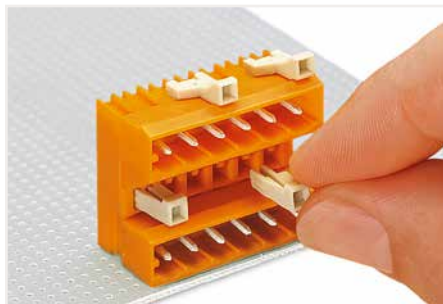

Coding a lower male header – inserting coding key(s).

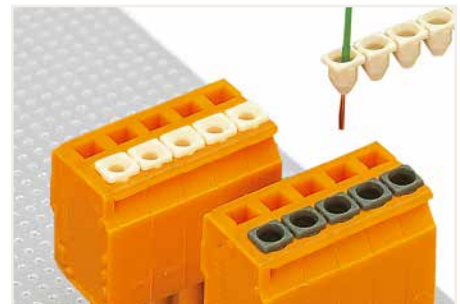

Using insulation stops for smaller cross-sections.



Inserting a conductor via operating tool.



Covering unused clamping units in CAGE CLAMP®-equipped male and female connectors (e.g., when doubling the pin spacing to meet clearance and creepage distance requirements, or when a higher rated voltage is required). Lockout pins are not suitable for panel-mount, angled female connectors.

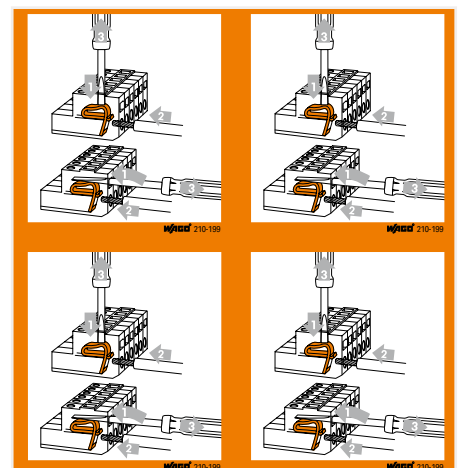

Stickers with operating instructions (210-199)

# PCB Terminal Blocks

## System Description and Handling

### Actuation with Locking Slide/Push-Button/ Lever

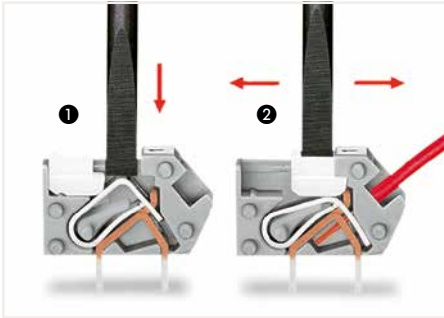

Conductor termination: ❶ To momentarily open the clamping unit, use a screwdriver and then insert a stripped conductor. ❷ To open clamping unit for an extended period, move locking slide toward conductor entry hole. Then fully insert stripped conductor and move locking slide back to original position (also possible to perform with fingernail) – 218 Series.

### Actuation without Locking Slide/Push-Button/ Lever

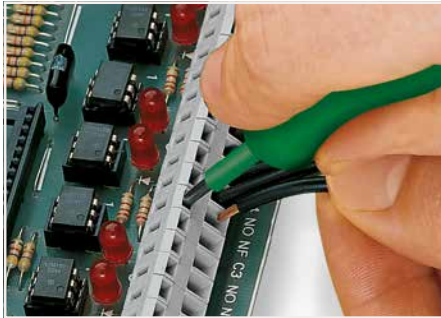

Inserting a conductor with operating tool (3.5 mm blade) Conductor entry and clamp operation are parallel – 236 Series

### Testing

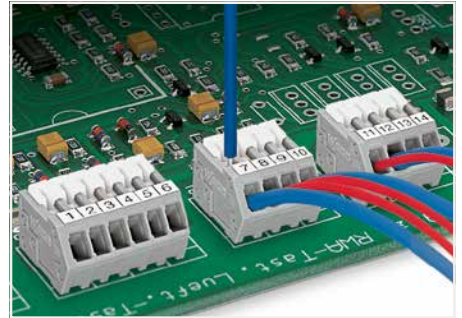

Inserting/removing a conductor – 218 Series

4

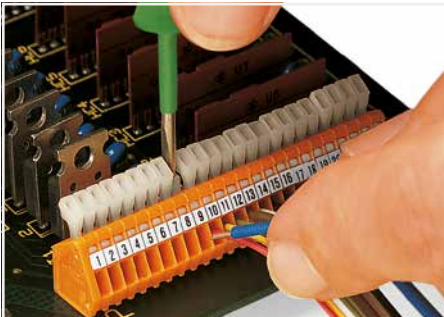

Inserting/removing a conductor – 234 Series.

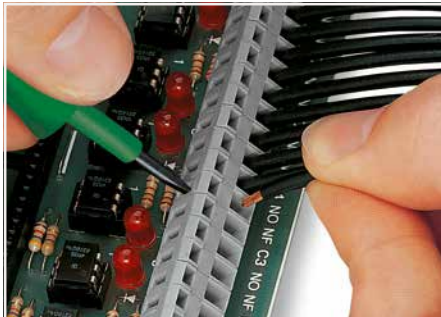

Inserting a conductor with operating tool (3.5 mm blade) Screwdriver actuation perpendicular to conductor entry – 236 Series

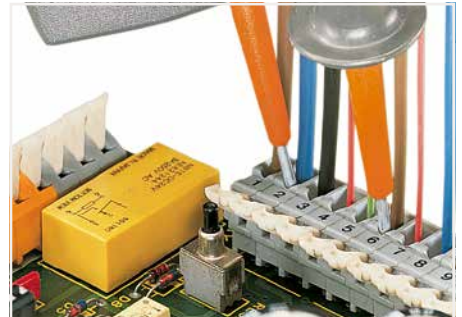

Testing with test probes – 255 Series

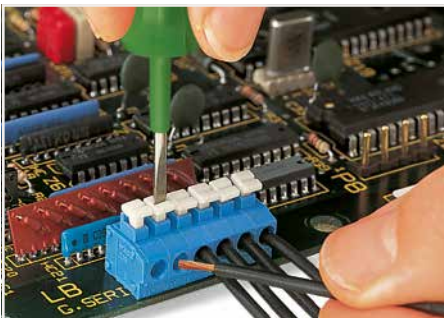

Inserting/removing fine-stranded conductors via push-button – 235 Series.

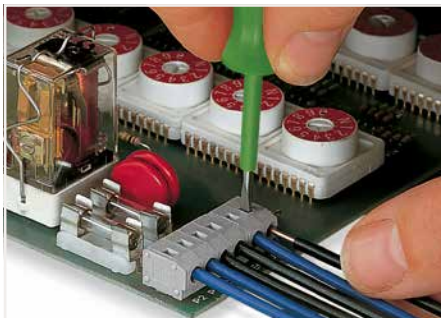

Removing a conductor via push-button – 235 Series.



Inserting/removing a conductor via finger-operated lever – 257 Series.

For terminal strips with finger-operated levers, see Full Line Catalog.

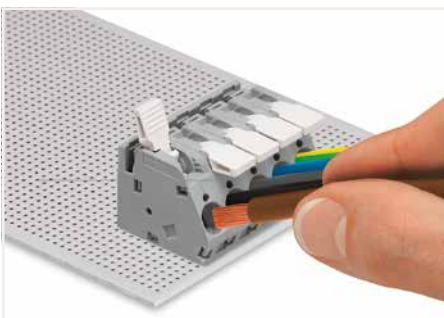

Inserting/removing a conductor – 2706 and 2716 Series.

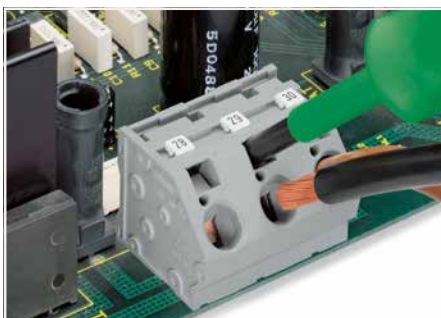

Inserting a conductor via operating tool (5.5 mm blade) – 745 Series.



Testing via 2 mm Ø test plug – 250 Series.

Marking

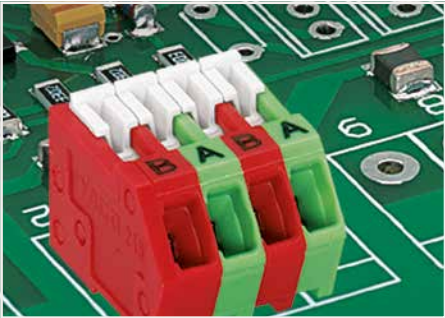

Directly marked at the factory

Commoning



Inserting a comb-style jumper bar – 745 Series.

Special Functions



For terminal strips in other colors, please contact factory



Marking via self-adhesive marking strips (see illustration) or marking directly at the factory

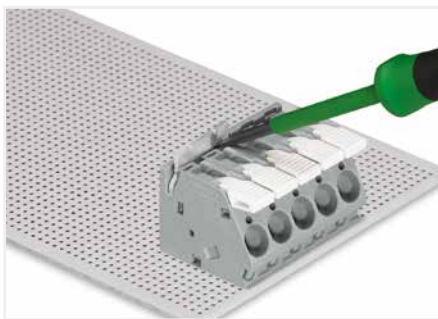

Push jumper bar down firmly using a screwdriver until it hits the backstop – 2706 and 2716 Series.

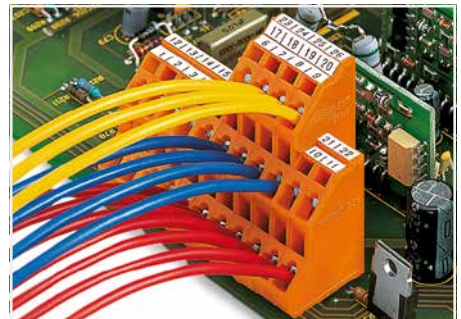

Save space with double- and triple-deck terminal blocks – 736 and 737 Series



Mixed-color terminal strips, directly marked at the factory



Solid conductors allow direct push-in termination; fine-stranded conductors can only be connected with lever open – 2606 Series

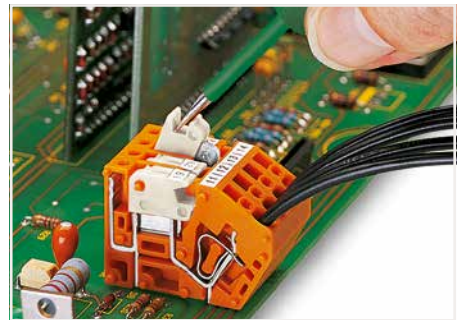

Opening a knife disconnect – 742 Series

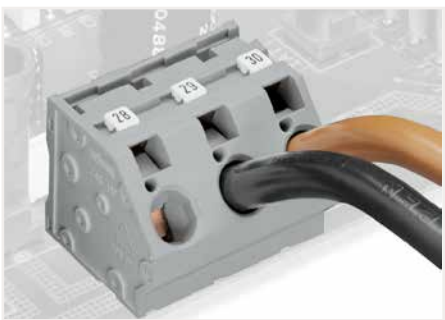

Marking via Mini-WSB and WMB markers or factory direct marking – 745 Series.



Test slot on top and on the conductor side – 2606 and 2616 Series

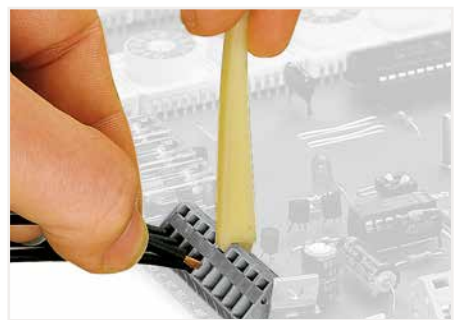

Inserting a conductor via operating tool – 236 Series.

# PCB Terminal Blocks

## Product Overview by Pin Spacing

Housing colors available upon request:

- Green-yellow
- Gray
- Dark gray
- Light gray
- White
- Orange
- Light green
- Black
- Blue
- Red
- Yellow
- Brown
- Green
- Violet
- Pink

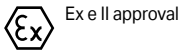

Ex e II approval

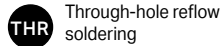

Through-hole reflow soldering

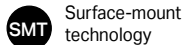

Surface-mount technology

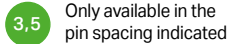

Only available in the pin spacing indicated

2.5 mm		2.54 mm		3.5 mm		3.81 mm	
Item No.	Pack. Unit	Item No.	Pack. Unit	Item No.	Pack. Unit	Item No.	Pack. Unit
233 Series; 2 ... 24 poles; 160 V / 6 A		233 Series; 2 ... 24 poles; 160 V / 6 A		739 Series; 2 ... 12 poles; 160 V / 17.5 A		739 Series; 2 ... 12 poles; 320 V / 17.5 A	
0.08 ... 0.5 mm <sup>2</sup> / 28 ... 20 AWG		0.08 ... 0.5 mm <sup>2</sup> / 28 ... 20 AWG		0.08 ... 1.5 mm <sup>2</sup> / 28 ... 14 AWG		0.08 ... 1.5 mm <sup>2</sup> / 28 ... 14 AWG	
○ 233-102 600		○ 233-402 600		○ 739-302 560		○ 739-332 520	
○ 233-124 80		○ 233-424 80		○ 739-312 100		○ 739-342 100	
233 Series; 2 ... 24 poles; 160 V / 6 A		233 Series; 2 ... 24 poles; 160 V / 6 A		805 Series; 2 ... 24 poles; 320 V / 17.5 A		235 Series; 1 ... 48 poles; 320 V / 17.5 A	
0.08 ... 0.5 mm <sup>2</sup> / 28 ... 20 AWG		0.08 ... 0.5 mm <sup>2</sup> / 28 ... 20 AWG		0.2 ... 1.5 mm <sup>2</sup> / 24 ... 16 AWG		0.5 ... 1.5 mm <sup>2</sup> / 20 ... 16 AWG	
○ 233-202 600		○ 233-502 600		○ 805-102 580		○ 235-101 520	
○ 233-224 80		○ 233-524 80		○ 805-124 40		○ 235-148 20	
234 Series; 2 ... 24 poles; 160 V / 6 A		234 Series; 2 ... 24 poles; 160 V / 6 A		805 Series; 2 ... 8 poles; 320 V / 17.5 A		235 Series; 1 ... 48 poles; 320 V / 17.5 A	
0.08 ... 0.5 mm <sup>2</sup> / 28 ... 20 AWG		0.08 ... 0.5 mm <sup>2</sup> / 28 ... 20 AWG		0.2 ... 1.5 mm <sup>2</sup> / 24 ... 16 AWG		0.5 ... 1.5 mm <sup>2</sup> / 20 ... 16 AWG "s"	
○ 234-202 600		○ 234-502 600		● 805-302/200-604 600		○ 235-101/330-000 520	
○ 234-224 80		○ 234-524 80		● 805-308/200-604 160		○ 235-148/330-000 20	
250 Series; 2 ... 24 poles; 160 V / 4 A		250 Series; 2 ... 24 poles; 160 V / 4 A		250 Series; 2 ... 24 poles; 160 V / 8 A		735 Series; 2 ... 7 poles; 320 V / 10 A	
0.2 ... 0.5 mm <sup>2</sup> / 24 ... 20 AWG		0.2 ... 0.5 mm <sup>2</sup> / 24 ... 20 AWG		0.2 ... 1.5 mm <sup>2</sup> / 24 ... 16 AWG		0.5 ... 1.5 mm <sup>2</sup> / 20 ... 16 AWG "s"	
○ 250-402 720		○ 250-1402 720		○ 250-102 560		○ 735-122 660	
○ 250-424 60		○ 250-1424 60		○ 250-124 40		○ 735-127 180	
250 Series; 2 ... 8 poles; 160 V / 4 A		250 Series; 2 ... 24 poles; 160 V / 4 A		250 Series; 2 ... 24 poles; 250 V / 8 A			
0.2 ... 0.5 mm <sup>2</sup> / 24 ... 20 AWG		0.2 ... 0.5 mm <sup>2</sup> / 24 ... 20 AWG		0.2 ... 1.5 mm <sup>2</sup> / 24 ... 16 AWG			
● 250-402/350-604 720				○ 250-202 560			
● 250-408/350-604 220				○ 250-224 40			
218 Series; 2 ... 24 poles; 160 V / 6 A		218 Series; 2 ... 24 poles; 160 V / 6 A		250 Series; 2 ... 8 poles; 320 V / 8 A			
0.08 ... 0.5 mm <sup>2</sup> / 28 ... 20 AWG		0.08 ... 0.5 mm <sup>2</sup> / 28 ... 20 AWG		0.2 ... 1.5 mm <sup>2</sup> / 24 ... 16 AWG			
○ 218-102 1000		○ 218-502 1000		● 250-202/353-604 560			
○ 218-124 60		○ 218-524 60		● 250-208/353-604 160			
218 Series; 2 ... 7 poles; 160 V / 6 A		218 Series; 2 ... 7 poles; 160 V / 6 A		744 Series; 2 ... 10 poles; 320 V / 2 A			
0.08 ... 0.5 mm <sup>2</sup> / 28 ... 20 AWG		0.08 ... 0.5 mm <sup>2</sup> / 28 ... 20 AWG		0.5 ... 1.5 mm <sup>2</sup> / 20 ... 16 AWG "s"			
● 218-102/000-604 1000		● 218-502/000-604 1000		○ 744-392 1500			
● 218-107/000-604 240		● 218-507/000-604 240		○ 744-310 200			

# PCB Terminal Blocks

## Product Overview by Pin Spacing

5 mm					
Item No.	Pack. Unit	Item No.	Pack. Unit	Item No.	Pack. Unit
236 Series; 1 ... 48 poles; 320 V / 24 A		236 Series; 2 ... 6 poles; 320 V / 24 A		742 Series; 1 ... 3 conductors, 320 V / 16 A	235 Series; 2 ... 12 poles; 320 V / 17.5 A
0.08 ... 2.5 mm <sup>2</sup> / 28 ... 12 AWG		0.08 ... 2.5 mm <sup>2</sup> / 28 ... 12 AWG		0.08 ... 2.5 mm <sup>2</sup> / 28 ... 12 AWG	0.5 ... 1.5 mm <sup>2</sup> / 20 ... 14 AWG
○ 236-101 420		● 236-402/334-604 420		○ 742-101 384	○ 235-402/331-000 420
○ 236-148 20		● 236-406/334-604 140		○ 742-153 100	○ 235-412/331-000 60
736 Series; 2 x 2 ... 24 x 2 poles; 320 V / 21 A		740 Series; 2 ... 24 poles; 320 V / 16 A		742 Series; 1 conductor/2 conductors, 320 V / 16 A	2604 Series; 2 ... 12 poles; with lever; 400 V / 32 A
0.08 ... 2.5 mm <sup>2</sup> / 28 ... 12 AWG		0.08 ... 2.5 mm <sup>2</sup> / 28 ... 12 AWG		0.08 ... 2.5 mm <sup>2</sup> / 28 ... 12 AWG	0.2 ... 4 mm <sup>2</sup> / 24 ... 12 AWG
○ 736-102 161		○ 740-102 460		○ 742-121 300	○ 2604-1102 200
○ 736-124 14		○ 740-124 40		○ 742-178 200	○ 2604-1112 30
737 Series; 2 x 3 ... 24 x 3 poles; 320 V / 21 A		253 Series; 2 ... 16 poles; 320 V / 17.5 A		742 Series; 1 ... 3 conductors, 320 V / 15 A	2624 Series; 2 ... 12 poles; 400 V / 41 A
0.08 ... 2.5 mm <sup>2</sup> / 28 ... 12 AWG		0.5 ... 1.5 mm <sup>2</sup> / 20 ... 16 AWG "s"		0.08 ... 2.5 mm <sup>2</sup> / 28 ... 12 AWG	0.2 ... 6 mm <sup>2</sup> / 24 ... 10 AWG
○ 737-102 92		○ 253-102 400		○ 742-111 300	○ 2624-1102 200
○ 737-124 8		○ 253-116 40		○ 742-163 100	○ 2624-1112 35
738 Series; 2 x 4 ... 24 x 4 poles; 320 V / 18 A		250 Series; 2 ... 16 poles; 320 V / 17.5 A		741 Series; 2 ... 16 poles; 320 V / 16 A	231 Series; 2 ... 12 poles; 320 V / 16 A
0.08 ... 2.5 mm <sup>2</sup> / 28 ... 12 AWG		0.5 ... 1.5 mm <sup>2</sup> / 20 ... 16 AWG		0.08 ... 2.5 mm <sup>2</sup> / 28 ... 12 AWG	0.08 ... 2.5 mm <sup>2</sup> / 28 ... 12 AWG
○ 738-102 72		○ 250-502 400		○ 741-102 400	○ 231-602/017-000 100
○ 738-124 6		○ 250-516 40		○ 741-116 40	○ 231-612/017-000 25
255 Series; 1 ... 48 poles; 320 V / 24 A		250 Series; 2 ... 24 poles; 320 V / 10 A		735 Series; 2 ... 7 poles; 320 V / 10 A	731 Series; 2 ... 12 poles; 320 V / 5 A
0.08 ... 2.5 mm <sup>2</sup> / 28 ... 12 AWG		0.5 ... 1.5 mm <sup>2</sup> / 20 ... 16 AWG		0.5 ... 1.5 mm <sup>2</sup> / 20 ... 16 AWG "s"	0.08 ... 2.5 mm <sup>2</sup> / 28 ... 12 AWG
○ 255-401 400		○ 250-702 264		○ 735-302 500	○ 731-132 50
○ 255-448 20		○ 250-724 24		○ 735-307 140	○ 731-142/048-000 25
256 Series; 1 ... 48 poles; 320 V / 24 A		816 Series; 2 ... 12 poles; 320 V / 14 A		235 Series; 2 ... 48 poles; 320 V / 24 A	
0.08 ... 2.5 mm <sup>2</sup> / 28 ... 12 AWG		2 x 0.2 ... 1.5 mm <sup>2</sup> / 2 x 24 ... 16 AWG		0.5 ... 2.5 mm <sup>2</sup> / 20 ... 14 AWG "s"	
○ 256-401 400		○ 816-102 400		○ 235-402 421	
○ 256-448 20		○ 816-112 60		○ 235-448 20	
257 Series; 1 ... 48 poles; 320 V / 24 A		254 Series; 1 ... 48 poles; 320 V / 24 A		745 Series; 2 ... 12 poles; 320 V / 32 A	
0.08 ... 2.5 mm <sup>2</sup> / 28 ... 12 AWG		0.5 ... 2.5 mm <sup>2</sup> / 20 ... 12 AWG "s"		0.08 ... 4 mm <sup>2</sup> / 28 ... 12 AWG	
○ 257-401 400		○ 254-451 420		○ 745-3102 276	
○ 257-448 20		○ 254-498 20		○ 745-3112 48	
739 Series; 2 ... 24 poles; 320 V / 24 A		804 Series; 2 ... 16 poles; 320 V / 24 A		745 Series; 2 ... 12 poles; 320 V / 32 A	
0.08 ... 2.5 mm <sup>2</sup> / 28 ... 12 AWG		0.25 ... 2.5 mm <sup>2</sup> / 20 ... 12 AWG		0.08 ... 4 mm <sup>2</sup> / 28 ... 12 AWG	
○ 739-102 400		○ 804-102 420		○ 745-102 230	
○ 739-124 20		○ 804-116 60		○ 745-112 40	

# PCB Terminal Blocks











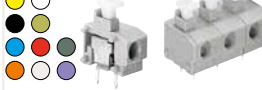

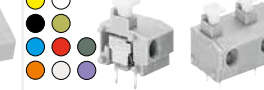



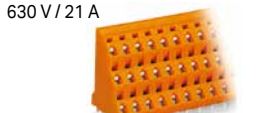







## Product Overview by Pin Spacing

5.08 mm				7.5 mm			
Item No.	Pack. Unit	Item No.	Pack. Unit	Item No.	Pack. Unit	Item No.	Pack. Unit
236 Series; 1 ... 48 poles; 320 V / 24 A		742 Series; 1 ... 3 conductors, 320 V / 16 A		236 Series; 1 ... 24 poles; 630 V / 24 A	Ex	235 Series; 1 ... 24 poles; 630 V / 17.5 A	745 Series; 2 ... 12 poles; 630 V / 32 A
0.08 ... 2.5 mm <sup>2</sup> / 28 ... 12 AWG		0.08 ... 2.5 mm <sup>2</sup> / 28 ... 12 AWG		0.08 ... 2.5 mm <sup>2</sup> / 28 ... 12 AWG		0.5 ... 1.5 mm <sup>2</sup> / 20 ... 14 AWG	0.08 ... 4 mm <sup>2</sup> / 28 ... 12 AWG
236-101 420		742-106 384		236-201 280		235-501/331-000 280	745-3152 228
236-148 20		742-158 100		236-224 20		235-524/331-000 20	745-3162 36
736 Series; 2 x 2 ... 24 x 2 poles; 320 V / 21 A		742 Series; 1 conductor/2 conductors, 320 V / 16 A		736 Series; 2 x 2 ... 16 x 2 poles; 630 V / 21 A		235 Series; 1 ... 24 poles; 630 V / 24 A	745 Series; 2 ... 12 poles; 630 V / 32 A
0.08 ... 2.5 mm <sup>2</sup> / 28 ... 12 AWG		0.08 ... 2.5 mm <sup>2</sup> / 28 ... 12 AWG		0.08 ... 2.5 mm <sup>2</sup> / 28 ... 12 AWG		0.5 ... 2.5 mm <sup>2</sup> / 20 ... 14 AWG "s"	0.08 ... 4 mm <sup>2</sup> / 28 ... 12 AWG
736-302 161		742-126 300		736-502 133		235-501 280	745-152 180
736-324 14		742-176 200		736-516 14		235-524 20	745-162 30
737 Series; 2 x 3 ... 24 x 3 poles; 320 V / 21 A		742 Series; 1 ... 3 conductors, 320 V / 15 A		737 Series; 2 x 3 ... 16 x 3 poles; 630 V / 21 A		254 Series; 1 ... 24 poles; 630 V / 24 A	745 Series; 2 ... 12 poles; 630 V / 41 A
0.08 ... 2.5 mm <sup>2</sup> / 28 ... 12 AWG		0.08 ... 2.5 mm <sup>2</sup> / 28 ... 12 AWG		0.08 ... 2.5 mm <sup>2</sup> / 28 ... 12 AWG		0.5 ... 2.5 mm <sup>2</sup> / 20 ... 12 AWG "s"	0.2 ... 6 mm <sup>2</sup> / 24 ... 10 AWG
737-302 92		742-116 300		737-502 76		254-551 280	745-302 128
737-324 8		742-168 100		737-516 8		254-574 20	745-312 16
738 Series; 2 x 4 ... 24 x 4 poles; 320 V / 18 A		741 Series; 2 ... 16 poles; 320 V / 16 A		255 Series; 1 ... 24 poles; 630 V / 24 A	Ex	741 Series; 2 ... 10 poles; 630 V / 16 A	2706 Series; 2 ... 12 poles; 630 V / 41 A
0.08 ... 2.5 mm <sup>2</sup> / 28 ... 12 AWG		0.08 ... 2.5 mm <sup>2</sup> / 28 ... 12 AWG		0.08 ... 2.5 mm <sup>2</sup> / 28 ... 12 AWG		0.08 ... 2.5 mm <sup>2</sup> / 28 ... 12 AWG	0.5 ... 6 mm <sup>2</sup> / 20 ... 10 AWG
738-302 72		741-202 400		255-501 280		741-302 340	2706-102 85
738-324 6		741-216 40		255-524 20		741-310 60	2706-112 15
255 Series; 1 ... 48 poles; 320 V / 24 A	Ex			256 Series; 1 ... 24 poles; 320 V / 24 A	Ex	250 Series; 2 ... 12 poles; 630 V / 17.5 A	2706 Series; 2 ... 12 poles; 630 V / 41 A
0.08 ... 2.5 mm <sup>2</sup> / 28 ... 12 AWG				0.08 ... 2.5 mm <sup>2</sup> / 28 ... 12 AWG		0.5 ... 1.5 mm <sup>2</sup> / 20 ... 16 AWG	0.5 ... 6 mm <sup>2</sup> / 20 ... 10 AWG
255-401 400				256-501 280		250-602 340	2706-152 85
255-448 20				256-524 20		250-612 40	2706-162 15
256 Series; 1 ... 48 poles; 320 V / 24 A	Ex	235 Series; 1 ... 48 poles; 320 V / 24 A		257 Series; 1 ... 24 poles; 630 V / 24 A	Ex	804 Series; 2 ... 12 poles; 320 V / 24 A	746 Series; 2 ... 12 poles; 1000 V / 50 A
0.08 ... 2.5 mm <sup>2</sup> / 28 ... 12 AWG		0.5 ... 2.5 mm <sup>2</sup> / 20 ... 14 AWG "s"		0.08 ... 2.5 mm <sup>2</sup> / 28 ... 12 AWG		0.25 ... 2.5 mm <sup>2</sup> / 20 ... 12 AWG	2 x 0.5 ... 10 mm <sup>2</sup> / 2 x 20 ... 8 AWG
256-401 400		235-401 420		257-501 280		804-302 340	746-2302 60
256-448 20		235-448 20		257-524 20		804-312 40	746-2312 16
257 Series; 1 ... 48 poles; 320 V / 24 A	Ex	254 Series; 1 ... 48 poles; 320 V / 24 A		739 Series; 2 ... 12 poles; 630 V / 24 A		2604 Series; 2 ... 12 poles; with lever; 630 V / 32 A	2624 Series; 2 ... 12 poles; 630 V / 41 A
0.08 ... 2.5 mm <sup>2</sup> / 28 ... 12 AWG		0.5 ... 2.5 mm <sup>2</sup> / 20 ... 12 AWG "s"		0.08 ... 2.5 mm <sup>2</sup> / 28 ... 12 AWG		0.2 ... 4 mm <sup>2</sup> / 24 ... 12 AWG	0.2 ... 6 mm <sup>2</sup> / 24 ... 10 AWG
257-401 400		254-451 420		739-202 340		2604-1302 200	2624-1302 200
257-448 20		254-498 20		739-212 40		2604-1312 30	2624-1312 25
739 Series; 2 ... 24 poles; 320 V / 24 A						2606 Series; 2 ... 12 poles; with lever; 1000 V / 41 A	2626 Series; 2 ... 12 poles; 1000 V / 41 A
0.08 ... 2.5 mm <sup>2</sup> / 28 ... 12 AWG						0.2 ... 10 mm <sup>2</sup> / 24 ... 8 AWG	0.2 ... 10 mm <sup>2</sup> / 24 ... 8 AWG
739-152 400						2606-1102/020-000 120	2626-1102/020-000 140
739-174 20						2606-1112/020-000 25	2626-1112/020-000 25

4

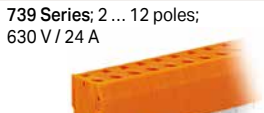



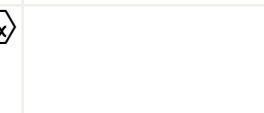





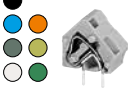
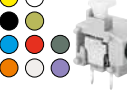

















# PCB Terminal Blocks

## Product Overview by Pin Spacing

7.62 mm				10 mm			
Item No.	Pack. Unit	Item No.	Pack. Unit	Item No.	Pack. Unit	Item No.	Pack. Unit
236 Series; 1 ... 24 poles; 630 V / 24 A		235 Series; 1 ... 24 poles; 630 V / 17.5 A		236 Series; 1 ... 24 poles; 1000 V / 10 A	Ex	235 Series; 1 ... 24 poles; 1000 V / 17.5 A	
							
0.08 ... 2.5 mm <sup>2</sup> / 28 ... 12 AWG		0.5 ... 1.5 mm <sup>2</sup> / 20 ... 14 AWG		0.08 ... 2.5 mm <sup>2</sup> / 28 ... 12 AWG		0.5 ... 1.5 mm <sup>2</sup> / 20 ... 14 AWG	
236-201	280	235-501/331-000	280	236-301	200	235-801/331-000	220
236-224	20	235-524/331-000	20	236-324	20	235-824/331-000	20
736 Series; 2 x 2 ... 16 x 2 poles; 630 V / 21 A		235 Series; 1 ... 24 poles; 630 V / 24 A		736 Series; 2 x 2 ... 12 x 2 poles; 1000 V / 21 A		235 Series; 1 ... 24 poles; 1000 V / 24 A	
							
0.08 ... 2.5 mm <sup>2</sup> / 28 ... 12 AWG		0.5 ... 2.5 mm <sup>2</sup> / 20 ... 14 AWG "s"		0.08 ... 2.5 mm <sup>2</sup> / 28 ... 12 AWG		0.5 ... 2.5 mm <sup>2</sup> / 20 ... 14 AWG "s"	
736-602	133	235-501	280	736-702	112	235-801	220
736-616	14	235-524	20	736-712	14	235-824	20
737 Series; 2 x 3 ... 16 x 3 poles; 630 V / 21 A		254 Series; 1 ... 24 poles; 630 V / 24 A		737 Series; 2 x 3 ... 12 x 3 poles; 1000 V / 21 A		254 Series; 1 ... 24 poles; 1000 V / 24 A	
							
0.08 ... 2.5 mm <sup>2</sup> / 28 ... 12 AWG		0.5 ... 2.5 mm <sup>2</sup> / 20 ... 12 AWG "s"		0.08 ... 2.5 mm <sup>2</sup> / 28 ... 12 AWG		0.5 ... 2.5 mm <sup>2</sup> / 20 ... 12 AWG "s"	
737-602	76	254-551	280	737-702	64	254-651	280
737-616	8	254-574	20	737-712	8	254-674	20
255 Series; 1 ... 24 poles; 630 V / 24 A	Ex	741 Series; 2 ... 10 poles; 630 V / 16 A		255 Series; 1 ... 24 poles; 1000 V / 24 A	Ex	741 Series; 2 ... 8 poles; 1000 V / 16 A	
							
0.08 ... 2.5 mm <sup>2</sup> / 28 ... 12 AWG		0.08 ... 2.5 mm <sup>2</sup> / 28 ... 12 AWG		0.08 ... 2.5 mm <sup>2</sup> / 28 ... 12 AWG		0.08 ... 2.5 mm <sup>2</sup> / 28 ... 12 AWG	
255-501	280	741-402	320	255-601	200	741-502	280
255-524	20	741-410	60	255-624	20	741-508	60
256 Series; 1 ... 24 poles; 320 V / 24 A	Ex			256 Series; 1 ... 24 poles; 630 V / 24 A	Ex	2616 Series; 2 ... 12 poles; with lever; 1000 V / 76 A	
							
0.08 ... 2.5 mm <sup>2</sup> / 28 ... 12 AWG				0.08 ... 2.5 mm <sup>2</sup> / 28 ... 12 AWG		0.75 ... 16 mm <sup>2</sup> / 18 ... 4 AWG	
256-501	280			256-601	200	2616-1102/020-000	50
256-524	20			256-624	20	2616-1112/020-000	10
257 Series; 1 ... 24 poles; 630 V / 24 A	Ex			257 Series; 1 ... 24 poles; 1000 V / 24 A	Ex	2636 Series; 2 ... 12 poles; 1000 V / 76 A	
							
0.08 ... 2.5 mm <sup>2</sup> / 28 ... 12 AWG				0.08 ... 2.5 mm <sup>2</sup> / 28 ... 12 AWG		0.75 ... 16 mm <sup>2</sup> / 18 ... 4 AWG	
257-501	280			257-601	200	2636-1102/020-000	50
257-524	20			257-624	20	2636-1112/020-000	15
739 Series; 2 ... 12 poles; 630 V / 24 A				739 Series; 2 ... 12 poles; 630 V / 24 A		2716 Series; 2 ... 8 poles; 320 V / 75 A	
							
0.08 ... 2.5 mm <sup>2</sup> / 28 ... 12 AWG				0.08 ... 2.5 mm <sup>2</sup> / 28 ... 12 AWG		1.5 ... 16 mm <sup>2</sup> / 16 ... 6 AWG	
739-232	340			739-3202	280	2716-102	65
739-242	40			739-3212	40	2716-108	15
				745 Series; 2 ... 12 poles; 1000 V / 32 A	Ex	2716 Series; 2 ... 8 poles; 1000 V / 76 A	
							
				0.08 ... 4 mm <sup>2</sup> / 28 ... 12 AWG		1.5 ... 16 mm <sup>2</sup> / 16 ... 6 AWG	
				745-3202	192	2716-152	52
				745-3212	24	2716-158	12

# PCB Terminal Blocks

## Product Overview by Pin Spacing





















10.16 mm		11.5 mm		12.5 mm		15 mm	
Item No.	Pack. Unit	Item No.	Pack. Unit	Item No.	Pack. Unit	Item No.	Pack. Unit
236 Series; 1 ... 24 poles; 1000 V / 10 A		235 Series; 1 ... 24 poles; 1000 V / 17.5 A		2604 Series; 2 ... 12 poles; with lever; 1000 V / 32 A		2606 Series; 2 ... 12 poles; 1000 V / 41 A	2616 Series; 2 ... 8 poles; 1000 V / 76 A
							
0.08 ... 2.5 mm <sup>2</sup> / 28 ... 12 AWG		0.5 ... 1.5 mm <sup>2</sup> / 20 ... 14 AWG		0.2 ... 4 mm <sup>2</sup> / 24 ... 12 AWG		0.2 ... 10 mm <sup>2</sup> / 24 ... 8 AWG	0.75 ... 16 mm <sup>2</sup> / 18 ... 4 AWG
236-301 200		235-801/331-000 220		2604-1502 130		2606-1352 80	2616-1352 44
236-324 20		235-824/331-000 20		2604-1512 15		2606-1362 12	2616-1358 14
736 Series; 2 x 2 ... 12 x 2 poles; 1000 V / 21 A		235 Series; 1 ... 24 poles; 1000 V / 24 A		2624 Series; 2 ... 12 poles; 1000 V / 41 A		2606 Series; 2 ... 12 poles; 1000 V / 41 A	2616 Series; 2 ... 8 poles; 1000 V / 76 A
							
0.08 ... 2.5 mm <sup>2</sup> / 28 ... 12 AWG		0.5 ... 2.5 mm <sup>2</sup> / 20 ... 14 AWG "s"		0.2 ... 6 mm <sup>2</sup> / 24 ... 10 AWG		0.2 ... 10 mm <sup>2</sup> / 24 ... 8 AWG	0.75 ... 16 mm <sup>2</sup> / 18 ... 4 AWG
736-802 112		235-801 220		2624-1502 100		2606-3352 80	2616-3352 44
736-812 14		235-824 20		2624-1512 20		2606-3362 12	2616-3358 14
737 Series; 2 x 3 ... 12 x 3 poles; 1000 V / 21 A		254 Series; 1 ... 24 poles; 1000 V / 24 A				2626 Series; 2 ... 12 poles; 1000 V / 48 A	2636 Series; 2 ... 8 poles; 1000 V / 76 A
							
0.08 ... 2.5 mm <sup>2</sup> / 28 ... 12 AWG		0.5 ... 2.5 mm <sup>2</sup> / 20 ... 12 AWG "s"				0.2 ... 10 mm <sup>2</sup> / 24 ... 8 AWG	0.75 ... 16 mm <sup>2</sup> / 18 ... 4 AWG
737-802 64		254-651 280				2626-1352 100	2636-1352 60
737-812 8		254-674 20				2636-1362 12	2636-1358 18
255 Series; 1 ... 24 poles; 1000 V / 24 A		741 Series; 2 ... 8 poles; 1000 V / 16 A				2626 Series; 2 ... 12 poles; 1000 V / 48 A	2636 Series; 2 ... 8 poles; 1000 V / 76 A
							
0.08 ... 2.5 mm <sup>2</sup> / 28 ... 12 AWG		0.08 ... 2.5 mm <sup>2</sup> / 28 ... 12 AWG				0.2 ... 10 mm <sup>2</sup> / 24 ... 8 AWG	0.75 ... 16 mm <sup>2</sup> / 18 ... 4 AWG
255-601 200		741-602 280				2636-3352 100	2636-3352 50
255-624 20		741-608 60				2636-3362 12	2636-3358 16
256 Series; 1 ... 24 poles; 630 V / 24 A						745 Series; 2 ... 12 poles; 1000 V / 32 A	745 Series; 2 ... 12 poles; 1000 V / 41 A
							
0.08 ... 2.5 mm <sup>2</sup> / 28 ... 12 AWG						0.08 ... 4 mm <sup>2</sup> / 28 ... 12 AWG	0.2 ... 6 mm <sup>2</sup> / 24 ... 10 AWG
256-601 200						745-3252 168	745-1452 64
256-624 20						745-3262 12	745-1462 8
257 Series; 1 ... 24 poles; 1000 V / 24 A						745 Series; 2 ... 12 poles; 1000 V / 41 A	745 Series; 2 ... 5 poles; 1000 V / 76 A
							
0.08 ... 2.5 mm <sup>2</sup> / 28 ... 12 AWG						0.2 ... 6 mm <sup>2</sup> / 24 ... 10 AWG	0.2 ... 16 mm <sup>2</sup> / 24 ... 6 AWG
257-601 200						745-1402 80	745-602/006-000 36
257-624 20						745-1412 8	745-605/006-000 12
						2706 Series; 2 ... 12 poles; 1000 V / 41 A	2716 Series; 2 ... 8 poles; 1000 V / 76 A
							
						0.5 ... 6 mm <sup>2</sup> / 20 ... 10 AWG	1.5 ... 16 mm <sup>2</sup> / 16 ... 6 AWG
						2706-302 65	2716-202 50
						2706-312 5	2716-208 10
							2716 Series; 2 ... 8 poles; 1000 V / 76 A
							
							1.5 ... 16 mm <sup>2</sup> / 16 ... 6 AWG
							2716-252 40
							2716-258 8

4



# PCB Terminal Blocks; Pluggable PCB Terminal Blocks; Jumpers

## Product Overview by Pin Spacing

20 mm		Pluggable PCB Terminal Block		Jumper	
Item No.	Pack. Unit	Item No.	Pack. Unit	Item No.	Pack. Unit
745 Series; 2 ... 5 poles; 1000 V / 76 A		252 Series; 2 ... 10 poles; 320 V / 2 A		Comb-Style Jumper Bar; 5 mm pin spacing; for 745 Series – 4 mm <sup>2</sup>	
					
0.2 ... 16 mm <sup>2</sup> / 24 ... 6 AWG		Ø 0.4 ... 0.8 mm "e" / AWG 26 ... 20 "s"		745-181	50
745-652/006-000	32	252-102	600	745-185	50
745-655/006-000	8	252-110	150	Comb-Style Jumper Bar; 7.5 mm pin spacing; for 745 Series – 4 mm <sup>2</sup>	
		252 Series; 2 ... 10 poles; 320 V / 2 A			
		Ø 0.4 ... 0.8 mm "e" / AWG 26 ... 20 "s"		745-191	50
		252-152	600	745-195	50
		252-160	150	Comb-Style Jumper Bar; 10 mm pin spacing; for 745 Series – 4 mm <sup>2</sup>	
		252 Series; 2 ... 10 poles; 320 V / 2 A			
		Ø 0.4 ... 0.8 mm "e" / AWG 26 ... 20 "s"		745-281	50
		252-302	600	745-285	50
		252-310	150	Comb-Style Jumper Bar; 7.5 mm pin spacing; for 745 Series and 2706 Series – 6 mm <sup>2</sup>	
		243 Series; 2 ... 8 poles; 320 V / 6 A			
		Ø 0.4 ... 1.0 mm / AWG 24 ... 18		745-381	50
		243-742	50	745-385	50
		243-748	50	Comb-Style Jumper Bar; 10 mm pin spacing; for 745 Series and 2706 Series – 6 mm <sup>2</sup>	
		806 Series; 2 ... 12 poles; 320 V / 10 A			
		2 x 0.2 ... 1.5 mm <sup>2</sup> / 2 x 24 ... 16 AWG		745-391	50
		806-102	400	745-395	50
		806-112	60	Comb-Style Jumper Bar; 10 mm pin spacing; for 745 Series and 2716 Series – 16 mm <sup>2</sup>	
				745-582	50
				745-585	50
				Comb-Style Jumper Bar; 15 mm pin spacing; for 745 Series and 2716 Series – 16 mm <sup>2</sup>	
				745-631	50
				745-635	50
				Comb-Style Jumper Bar; 20 mm pin spacing; for 745 Series and 2716 Series – 16 mm <sup>2</sup>	
				745-681	50
				745-685	50

# SMD PCB Terminal Blocks

## Product Overview by Pin Spacing

3 mm		4 mm		6 mm			
Item No.	Pack. Unit	Item No.	Pack. Unit	Item No.	Pack. Unit	Item No.	Pack. Unit
2059 Series; 1 ... 3 poles; 160 V/3 A	<b>SMT</b>	2060 Series; 1 ... 3 poles; 160 V/9 A	<b>SMT</b>	2061 Series; 1 ... 3 poles; solder pin length: 2.4 mm 320 V/17.5 A	<b>THR</b>	2061 Series; 1 ... 3 poles; solder pin length: 1.5 mm 320 V/17.5 A	<b>THR</b>
0.14 ... 0.5 mm <sup>2</sup> / 26 ... 20 AWG "s"		0.2 ... 0.75 mm <sup>2</sup> / AWG 24		0.5 ... 1.5 mm <sup>2</sup> / 20 ... 16 AWG		0.5 ... 1.5 mm <sup>2</sup> / 20 ... 16 AWG	
○ 2059-301/998-403 31800		○ 2060-451/998-404 13500		○ 2061-1601/998-404 5760		○ 2061-1641/998-404 5760	
○ 2059-303/998-403 21000		○ 2060-453/998-404 6750		○ 2061-1603/998-404 2880		○ 2061-1643/998-404 2880	
2059 Series; 1 ... 3 poles; 160 V/3 A	<b>SMT</b>	2060 Series; 1 ... 3 poles; 160 V/9 A	<b>SMT</b>	2061 Series; 1 ... 3 poles; solder pin length: 2.4 mm 320 V/17.5 A	<b>THR</b>	2061 Series; 1 ... 3 poles; solder pin length: 1.5 mm 320 V/17.5 A	<b>THR</b>
0.14 ... 0.5 mm <sup>2</sup> / 26 ... 20 AWG "s"		0.2 ... 0.75 mm <sup>2</sup> / AWG 24		0.5 ... 1.5 mm <sup>2</sup> / 20 ... 16 AWG		0.5 ... 1.5 mm <sup>2</sup> / 20 ... 16 AWG	
● 2059-321/998-403 31800		● 2060-471/998-404 13500		● 2061-1621/998-404 5760		● 2061-1661/998-404 5760	
● 2059-323/998-403 21000		● 2060-473/998-404 6750		● 2061-1623/998-404 2880		● 2061-1663/998-404 2880	
		2060 Series; 1 ... 3 poles; solder pin length: 2.4 mm 160 V/9 A	<b>THR</b>	2061 Series; 1 ... 3 poles; 320 V/17.5 A	<b>SMT</b>		
		0.2 ... 0.75 mm <sup>2</sup> / AWG 24		0.5 ... 1.5 mm <sup>2</sup> / 20 ... 16 AWG			
		○ 2060-1451/998-404 10800		○ 2061-601/998-404 8100			
		○ 2060-1453/998-404 4950		○ 2061-603/998-404 4050			
2075 Series; through-board; 1 pole	<b>SMT</b>	2060 Series; 1 ... 3 poles; solder pin length: 2.4 mm 160 V/9 A	<b>THR</b>	2061 Series; 1 ... 3 poles; 320 V/17.5 A	<b>SMT</b>		
0.34 ... 0.75 mm <sup>2</sup> / 20 ... 18 AWG "s"		0.2 ... 0.75 mm <sup>2</sup> / AWG 24		0.5 ... 1.5 mm <sup>2</sup> / 20 ... 16 AWG			
2075-381/997-404 18000		● 2060-1471/998-404 10800		● 2061-621/998-404 8100			
		● 2060-1473/998-404 4950		● 2061-623/998-404 4050			









Board-to-Board Link for SMD PCB Terminal Blocks with Push-Buttons			
Pin spacing: 3 mm; 1 ... 4 poles; pin length: 15.3 mm ①	Pin spacing: 4 mm; 1 ... 4 poles; pin length: 28 mm	Pin spacing: 6 mm; 1 ... 4 poles; pin length: 30 mm	Pin spacing: 6 mm; 1 ... 4 poles; pin length: 34 mm
2059-901 1500	2060-951/028-000 1500	2061-901 700	2061-901/034-000 700
2059-904 250	2060-954/028-000 250	2061-904 100	2061-904/034-000 100



Operating Tool			Advantages/benefits:
For 2059 Series	For 2060 Series	For 2061 Series	
			<ul style="list-style-type: none"> <li>• Low profiles minimize on-board LED shadowing</li> <li>• Push-in termination of solid conductors</li> <li>• Terminal strips of different lengths can be assembled without pole loss, reducing the number of variants and lowering production costs</li> <li>• Available in 1- to 3-pole configurations</li> <li>• Delivery in tape-and-reel packaging for full integration into SMT soldering process</li> <li>• Lower costs via automated pick-and-place assembly</li> </ul>
206-859 5	206-860 5	206-861 5	
Insulated; for 2059 Series	Insulated; for 2060 Series	Insulated; for 2061 Series	
2059-189 50	2060-189 50	2061-189 50	





① For other pin lengths (17.5/20 mm), see Full Line Catalog, volume 2, or www.wago.com.

# SMD PCB Terminal Blocks

## Product Overview by Pin Spacing

6.5 mm				8 mm	
Item No.	Pack. Unit	Item No.	Pack. Unit	Item No.	Pack. Unit
2065 Series; with push-button; 320 V / 9 A 	<b>SMT</b>	2070 Series; 1 ... 3 poles; without cover; 320 V / 9 A 	<b>SMT</b>	2060 Series; 2 poles, 630 V / 9 A 	<b>SMT</b>
0.2 ... 0.75 mm <sup>2</sup> / 24 ... 18 AWG 2065-100/998-403	31800	0.2 ... 0.75 mm <sup>2</sup> / 24 ... 18 AWG 2070-451/998-406	4770	0.2 ... 0.75 mm <sup>2</sup> / AWG 24 ○ 2060-852/998-404	6750
2065 Series; 320 V / 9 A 	<b>SMT</b>	2070 Series; 1 ... 3 poles; with cover; 320 V / 9 A 	<b>SMT</b>	2060 Series; 2 poles; solder pin length: 2.4 mm; 630 V / 9 A 	<b>THR</b>
0.2 ... 0.75 mm <sup>2</sup> / 24 ... 18 AWG "s" 2065-101/998-403	31800	0.2 ... 0.75 mm <sup>2</sup> / 24 ... 18 AWG 2070-461/998-406	4770	0.2 ... 0.75 mm <sup>2</sup> / AWG 24 ● 2060-1872/998-404	4590
		2070-463/998-406	1590	2060 Series; 2 poles; solder pin length: 2.4 mm; 630 V / 9 A 	<b>THR</b>
		2070 Series; 1 ... 3 poles; with cover and labeling; 320 V / 9 A 	<b>SMT</b>	0.2 ... 0.75 mm <sup>2</sup> / AWG 24 ○ 2060-1852/998-404	4590
		0.2 ... 0.75 mm <sup>2</sup> / 24 ... 18 AWG 2070-521/998-406	4770		
		2070-523/998-406	1590		

6.5 mm pin spacing	8 mm pin spacing; 2 poles
	
Length: 15.6 2065-131 1500 Length: 17.6 2065-133 1500	2060-962/028-000 375

Operating Tool			
	For 2070 Series 	For 2060 Series 	
	2070-400 1	206-860 5	
Insulated; for 2065 Series 		Insulated; for 2060 Series 	
2065-189 50		2060-189 50	

4

# TOMORROW'S BUILDINGS WILL BE BUILT WITH TODAY'S WINSTA® SYSTEM

Perfectly Plugged Electrical Building Installations



# SUCCESS THROUGH EXPERTISE

## Project Planning with WAGO

WAGO offers consulting and project planning services to help devise the best possible solution for your project. Our experienced team of professionals will be happy to help you implement your project with our products.

## Installation Examples



In suspended ceilings



WINSTA® MINI/MINI Special  
0.25 ... 1.5 mm<sup>2</sup> / 16 A / 400 V

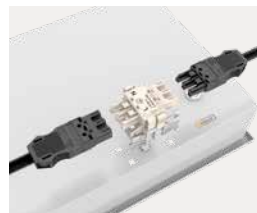

WINSTA® MIDI Linect®  
0.5 ... 4 mm<sup>2</sup> / 25 A / 400 V



Power distribution



WINSTA® MAXI  
0.5 ... 6 mm<sup>2</sup> / 35 A / 400 V



WINSTA® RD  
1.5 and 2.5 mm<sup>2</sup> / 20 A / 250 V

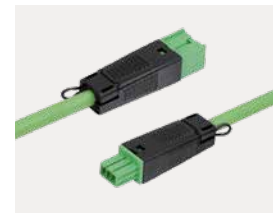

WINSTA® KNX  
max. Ø 0.8 mm / 3 A / 50 V

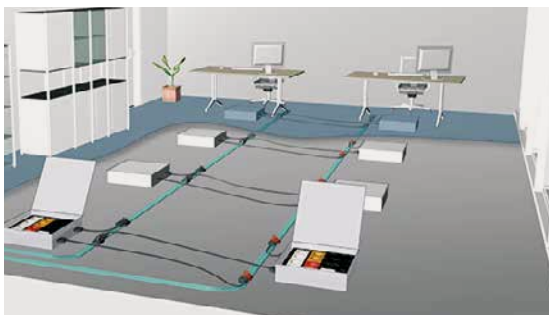

In raised floors



WINSTA® MIDI/MIDI Special  
0.5 ... 4 mm<sup>2</sup> / 25 A / 400 V

## WINSTA® – the Pluggable Connection System

### WINSTA® MINI

For Applications in Tight Spaces

- Sensors  
(switches, push-buttons, window contacts, pressure switches, temperature sensors, etc.)
- Actuators  
(control valves, magnetic valves, servo motors, blinds/sun protection, etc.)
- Protection class II for halogen lamps and luminaires
- Control signals
- 1.5 mm<sup>2</sup> (16 AWG), 250 V, 16 A
- IP40-capable for use in easily accessible areas

2- ... 5-pole  
890 and 891 Series



### WINSTA® MIDI

For Maximum Possibilities

- General building installation, especially for modern functional buildings
- Standard lighting fixtures and safety lights
- Tradeshow and shop installation
- Motor homes
- Lab work stations
- Rolling stock
- Shipbuilding
- 4 mm<sup>2</sup> (12 AWG), 250/400 V, 25 A

2- ... 5-pole  
770 and 771 Series



### WINSTA® MAXI

For High-Power Applications

- Power supply via 6 mm<sup>2</sup> (10 AWG) cable for extended cable runs
- 32 A power supply in distribution boxes for high energy requirements
- 6 mm<sup>2</sup> (10 AWG), 250/400 V, 35 A

5-pole  
831 Series



### WINSTA® MINI Special

For Specialty Applications

2- ... 5-pole  
890 and 891 Series



### WINSTA® MIDI Special

For Specialty Applications

2- ... 5-pole  
770 and 771 Series



**WINSTA® KNX**

For the Standardized Bus

- KNX/EIB
- Control signals
- Ø 0.8 mm, 50 V, 3 A

2-pole  
893 and 894 Series

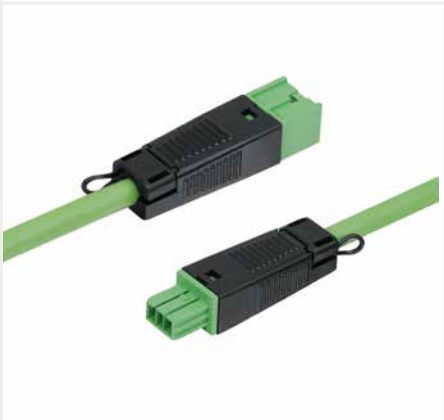

**WINSTA® RD**

For Round Conduits and Ducts

- Outside diameter of 17.5 mm for applications in electrical conduits with an inner diameter > 18 mm
- Prefabricated houses
- Recessed luminaires
- Wall and ceiling cutouts

3 and 4 poles  
774 Series



**WINSTA® Boxes**

For a Variety of Applications

- Customize the box by configuring the number of slots and assigning their functions.
- Easily provide outputs via all variants of WINSTA® Snap-In Device Connectors.
- Install DIN-rail-mount components, such as circuit breakers, fuses and relays.

899 Series

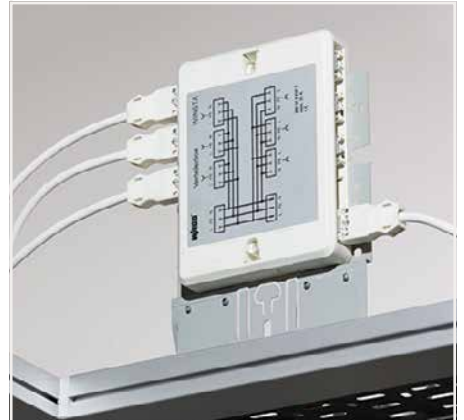

# WAGO WINSTA® MINI Pluggable Connection System Usage

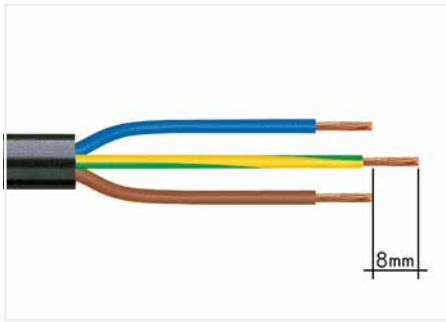

1. Strip length, outer insulation = x mm
2. Strip length = 9 mm
3. Extended ground conductor = 8 mm

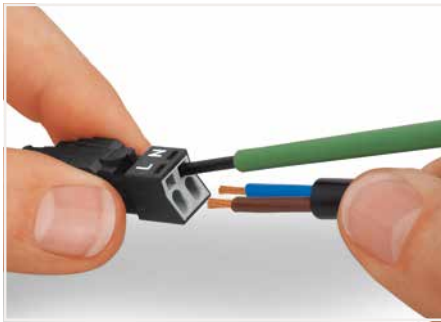

To terminate fine-stranded conductors, open the clamping unit via screwdriver – 2.5 mm blade width – and insert a stripped conductor until it hits the backstop. Terminate solid conductors by simply pushing them in.



Latch the wired connector into the base of the strain relief housing.



Push down strain relief clamp by hand.



Push down strain relief clamp with 2.5 mm screwdriver alternately on both sides.



Snap on the top of the strain relief housing.

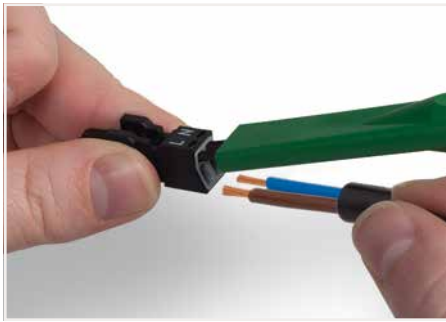

To terminate fine-stranded conductors, open clamping units via operating tool (890-382) and insert stripped conductors until they hit backstop. Terminate solid conductors by simply pushing them in.

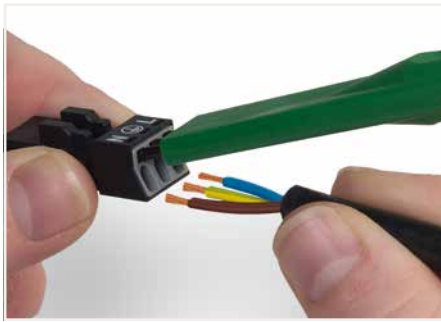

To terminate fine-stranded conductors, open clamping units via operating tool (890-383) and insert stripped conductors until they hit backstop. Terminate solid conductors by simply pushing them in.



Connector with shield termination



Apply the shield to the sheathed cable. Strip length, outer insulation = 30 mm Shield length = 8 mm



Push the shield connecting plate into the connector until fully inserted.



First insert the wired connector into a strain relief housing, then snap clamp and cover.

5



## WAGO WINSTA® MINI Pluggable Connection System

Illustration	Color	Pole Number	Coding	Marking	Rated Voltage	Rated Surge Voltage	Rated Current	Cable Diameter	Item No.	Pack. Unit
<b>WINSTA® MINI; socket without strain relief housing</b>										
	●	2	A	L N	250 V	4 kV	16 A		890-202	50
	○	2	A	L N	250 V	4 kV	16 A		890-222	50
	●	2	I	+ -	250 V	4 kV	16 A		890-1102	50
	●	3	A	L ⊕ N	250 V	4 kV	16 A		890-203	50
	○	3	A	L ⊕ N	250 V	4 kV	16 A		890-223	50
	●	4	A	N ⊕ 2/L 1/L'	400 V	6 kV	16 A		890-204	50
	○	4	A	N ⊕ 2/L 1/L'	400 V	6 kV	16 A		890-224	50
	●	5	A	N ⊕ L + -	400 V	6 kV	13 A		890-205	50
	○	5	A	N ⊕ L + -	400 V	6 kV	13 A		890-225	50
●	5	I	N ⊕ L + -	400 V	6 kV	16 A		890-1105	50	
<b>WINSTA® MINI; plug without strain relief housing</b>										
	●	2	A	L N	250 V	4 kV	16 A		890-212	50
	○	2	A	L N	250 V	4 kV	16 A		890-232	50
	●	2	I	+ -	250 V	4 kV	16 A		890-1112	50
	●	3	A	L ⊕ N	250 V	4 kV	16 A		890-213	50
	○	3	A	L ⊕ N	250 V	4 kV	16 A		890-233	50
	●	4	A	N ⊕ 2/L 1/L'	400 V	6 kV	16 A		890-214	50
	○	4	A	N ⊕ 2/L 1/L'	400 V	6 kV	16 A		890-234	50
	●	5	A	N ⊕ L + -	400 V	6 kV	13 A		890-215	50
	○	5	A	N ⊕ L + -	400 V	6 kV	13 A		890-235	50
●	5	I	N ⊕ L + -	400 V	6 kV	16 A		890-1115	50	
<b>WINSTA® MINI; snap-on type strain relief housing for socket and plug</b>										
	●	2						3.8 ... 8.2 mm	890-502	50
	○	2						3.8 ... 8.2 mm	890-512	50
	●	3						4.5 ... 10 mm	890-503	50
	○	3						4.5 ... 10 mm	890-513	50
	●	4						6.5 ... 10.5 mm	890-504	50
	○	4						6.5 ... 10.5 mm	890-514	50
	●	5						6.5 ... 10.5 mm	890-505	50
	○	5						6.5 ... 10.5 mm	890-515	50
<b>WINSTA® MINI; snap-in socket</b>										
	●	2	A	L N	250 V	4 kV	16 A		890-702	50
	○	2	A	L N	250 V	4 kV	16 A		890-722	50
	●	2	I	+ -	250 V	4 kV	16 A		890-2102	50
	●	3	A	L ⊕ N	250 V	4 kV	16 A		890-703	50
	○	3	A	L ⊕ N	250 V	4 kV	16 A		890-723	50
	●	4	A	N ⊕ 2/L 1/L'	400 V	6 kV	16 A		890-704	50
	○	4	A	N ⊕ 2/L 1/L'	400 V	6 kV	16 A		890-724	50
	●	5	A	N ⊕ L + -	400 V	6 kV	13 A		890-705	50
	○	5	A	N ⊕ L + -	400 V	6 kV	13 A		890-725	50
●	5	I	N ⊕ L + -	400 V	6 kV	16 A		890-2105	50	
<b>WINSTA® MINI; snap-in plug</b>										
	●	2	A	L N	250 V	4 kV	16 A		890-712	50
	○	2	A	L N	250 V	4 kV	16 A		890-732	50
	●	2	I	+ -	250 V	4 kV	16 A		890-2112	50
	●	3	A	L ⊕ N	250 V	4 kV	16 A		890-713	50
	○	3	A	L ⊕ N	250 V	4 kV	16 A		890-733	50
	●	4	A	N ⊕ 2/L 1/L'	400 V	6 kV	16 A		890-714	50
	○	4	A	N ⊕ 2/L 1/L'	400 V	6 kV	16 A		890-734	50
	●	5	A	N ⊕ L + -	400 V	6 kV	13 A		890-715	50
	○	5	A	N ⊕ L + -	400 V	6 kV	13 A		890-735	50
●	5	I	N ⊕ L + -	400 V	6 kV	16 A		890-2115	50	

# WAGO WINSTA® MIDI Pluggable Connection System

## Handling

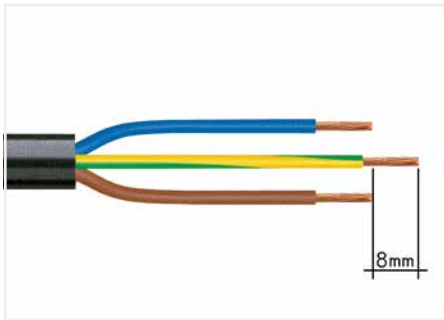

1. Strip length, outer insulation = x mm 1
2. Strip length = 9 mm
3. Extended ground conductor = 8 mm

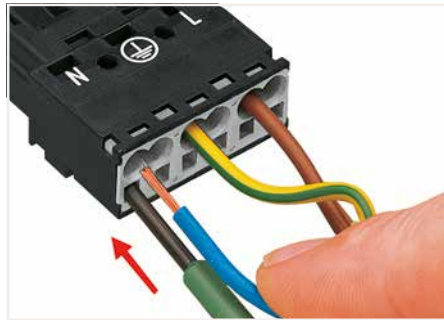

To terminate fine-stranded conductors, open the clamping unit via screwdriver (2.5 mm blade width) and insert a stripped conductor until it hits the backstop.

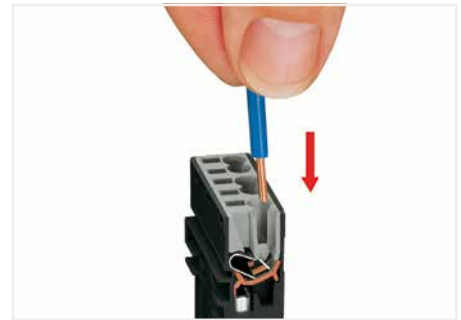

Insert the stripped solid conductor until it hits the backstop.

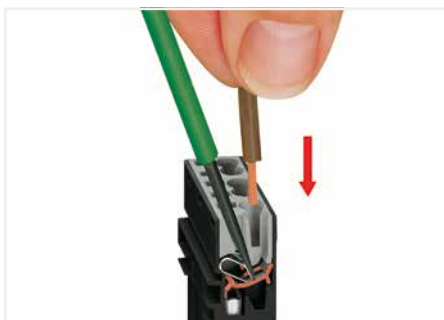

To terminate fine-stranded conductors, open the clamping unit via screwdriver (2.5 mm blade width) and insert a stripped conductor until it hits the backstop.

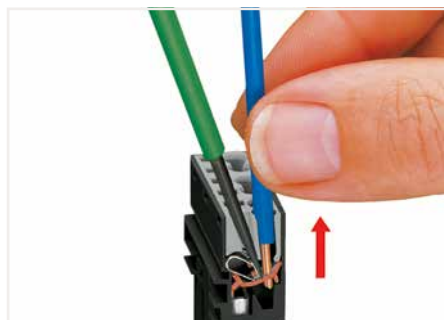

To remove the conductor, actuate the clamp via screwdriver (2.5 mm blade width) and pull out the conductor.



Latch the strain relief housing onto the plug/socket. Note the "TOP" inscription.



Prepare strain relief housing by snapping together upper and bottom part.



Tighten strain relief screw with screwdriver (2.5 mm blade width).



Insert coding pin into plug (break first) until it engages.



Apply the shield to the sheathed cable.  
Strip length, outer insulation = 55 mm  
Shield length = 10 mm



Push the shield connecting plate into the connector until fully inserted.



First insert the wired connector into strain relief housing, then snap cover and tighten screw.

5

## WAGO WINSTA® MIDI Pluggable Connection System

Illustration	Color	Pole Number	Coding	Marking	Rated Voltage	Rated Surge Voltage	Rated Current	Cable Diameter	Item No.	Pack. Unit
<b>WINSTA® MINI; socket without strain relief housing</b>										
	●	2	A	L N	250 V	4 kV	25 A		770-202	100
	○	2	A	L N	250 V	4 kV	25 A		770-222	100
	●	2	I	DA+ DA-	250 V	4 kV	25 A		770-1102	100
	●	2	L	L' N'	250 V	4 kV	25 A		770-1162	100
	●	3	A	L ⊕ N	250 V	4 kV	25 A		770-203	100
	○	3	A	L ⊕ N	250 V	4 kV	25 A		770-223	100
	●	3	P	L ⊕ N	250 V	4 kV	25 A		770-1303	100
	●	3	R	LON LON S	250 V	4 kV	25 A		770-1343	100
	●	3	S	1 2 L	250 V	4 kV	25 A		770-1363	100
	●	4	A	N ⊕ 2/L 1/L'	400 V	6 kV	25 A		770-204	100
	○	4	A	N ⊕ 2/L 1/L'	400 V	6 kV	25 A		770-224	100
	●	5	A	N ⊕ L1 L2 L3	400 V	6 kV	25 A		770-205	50
	○	5	A	N ⊕ L1 L2 L3	400 V	6 kV	25 A		770-225	50
	●	5	I	N ⊕ L DA+ DA-	400 V	6 kV	25 A		770-1105	50
	●	5	L	N ⊕ L N' L'	400 V	6 kV	25 A		770-1165	50
	●	5	P	N ⊕ L1 L2 L3	400 V	6 kV	25 A		770-1305	50
<b>WINSTA® MINI; plug without strain relief housing</b>										
	●	2	A	L N	250 V	4 kV	25 A		770-212	100
	○	2	A	L N	250 V	4 kV	25 A		770-232	100
	●	2	I	DA+ DA-	250 V	4 kV	25 A		770-1112	100
	●	2	L	L' N'	250 V	4 kV	25 A		770-1172	100
	●	3	A	L ⊕ N	250 V	4 kV	25 A		770-213	100
	○	3	A	L ⊕ N	250 V	4 kV	25 A		770-233	100
	●	3	P	L ⊕ N	250 V	4 kV	25 A		770-1313	100
	●	3	R	LON LON S	250 V	4 kV	25 A		770-1353	100
	●	3	S	1 2 L	250 V	4 kV	25 A		770-1373	100
	●	4	A	N ⊕ 2/L 1/L'	400 V	6 kV	25 A		770-214	100
	○	4	A	N ⊕ 2/L 1/L'	400 V	6 kV	25 A		770-234	100
	●	5	A	N ⊕ L1 L2 L3	400 V	6 kV	25 A		770-215	50
	○	5	A	N ⊕ L1 L2 L3	400 V	6 kV	25 A		770-235	50
	●	5	I	N ⊕ L DA+ DA-	400 V	6 kV	25 A		770-1115	50
	●	5	L	N ⊕ L N' L'	400 V	6 kV	25 A		770-1175	50
	●	5	P	N ⊕ L1 L2 L3	400 V	6 kV	25 A		770-1315	50
<b>WINSTA® MINI; snap-on type strain relief housing for socket and plug</b>										
	●	2						5 ... 9 mm	770-502/042-000	50
	○	2						5 ... 9 mm	770-512/042-000	50
	●	3						8 ... 11.5 mm	770-503	50
	○	3						8 ... 11.5 mm	770-513	50
	●	4						9 ... 13 mm	770-504	25
	○	4						9 ... 13 mm	770-514	25
	●	5						9 ... 13 mm	770-505	25
	○	5						9 ... 13 mm	770-515	25
<b>WINSTA® MINI; snap-in socket</b>										
	●	3	A	L ⊕ N	250 V	4 kV	25 A		770-703	100
	○	3	A	L ⊕ N	250 V	4 kV	25 A		770-723	100
	●	3	P	L ⊕ N	250 V	4 kV	25 A		770-2303	100
	●	3	R	LON LON S	250 V	4 kV	25 A		770-2343	100
	●	3	S	1 2 L	250 V	4 kV	25 A		770-2363	100
	●	4	A	N ⊕ 2/L 1/L'	400 V	6 kV	25 A		770-704	100
	○	4	A	N ⊕ 2/L 1/L'	400 V	6 kV	25 A		770-724	100
	●	5	A	N ⊕ L1 L2 L3	400 V	6 kV	25 A		770-705	50
	○	5	A	N ⊕ L1 L2 L3	400 V	6 kV	25 A		770-725	50
	●	5	I	N ⊕ L DA+ DA-	400 V	6 kV	25 A		770-2105	50
●	5	P	N ⊕ L1 L2 L3	400 V	6 kV	25 A		770-2305	50	
<b>WINSTA® MINI; snap-in plug</b>										
	●	3	A	L ⊕ N	250 V	4 kV	25 A		770-713	100
	○	3	A	L ⊕ N	250 V	4 kV	25 A		770-733	100
	●	3	P	L ⊕ N	250 V	4 kV	25 A		770-2313	100
	●	3	R	LON LON S	250 V	4 kV	25 A		770-2343	100
	●	4	A	N ⊕ 2/L 1/L'	400 V	6 kV	25 A		770-714	100
	○	4	A	N ⊕ 2/L 1/L'	400 V	6 kV	25 A		770-734	100
	●	5	A	N ⊕ L1 L2 L3	400 V	6 kV	25 A		770-715	50
	○	5	A	N ⊕ L1 L2 L3	400 V	6 kV	25 A		770-735	50
	●	5	I	N ⊕ L DA+ DA-	400 V	6 kV	25 A		770-2115	50
	●	5	P	N ⊕ L1 L2 L3	400 V	6 kV	25 A		770-2315	50

# WAGO Automation Technology

## Solutions

Cloud solutions  
Software applications

## Software

Engineering software  
Runtime software  
Mobile software (apps)

## Operation and Monitoring

Touch Panel 600 Standard Line  
Touch Panel 600 Advanced Line  
Touch Panel 600 Marine Line  
Touch Panel e!DISPLAY 7300T

## Controllers

Touch Panel 600 Standard Line  
Touch Panel 600 Advanced Line

PFC100/PFC200 Controllers  
PFC200 XTR Controllers  
750 Controllers  
750 XTR Controllers

## I/O Systems

763, 768, 750 and 753 Series  
Fieldbus couplers  
Digital input/output modules  
Analog input/output modules  
Function/technology modules  
Communication modules  
Functional safety  
Intrinsically safe modules  
Supply and segment modules

763 Series Advanced

750 XTR Series

765 Series Field

## Infrastructure

Industrial switches

Power supplies

Sensor/actuator boxes

Radio technology

## Solutions



- Cloud solutions
- Reusable, customizable software applications

## Touch Panel 600 Standard Line



- High-performance touch panels with resistive touch-screens
- 10.9 ... 25.7 cm (4.3 ... 10.1")
- Control, Visu or Web Panel versions for display of e!COCKPIT visualizations

## PFC100/PFC200 Controllers



- Maximum performance in minimum space
- Also programmable in high-level languages based on Linux®
- Security packages with SSH and SSL/TLS
- Runtime system for CODESYS V2 (only PFC200) and V3

## WAGO I/O System Advanced – 763/768 Series



- Innovative, future-proof industrial automation with TSN
- Multi-part modules
- Shorter response times and a high degree of synchronization
- Push-in connection technology with push-buttons

## Industrial switches



- Copper cable
- Fiber optic cable
- Ring redundancy

## Engineering software



- PC-based software
- Customized tools for every automation task

## Touch Panel 600 Advanced Line

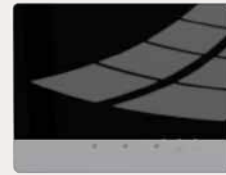

- High-performance touch panels with capacitive touch-screens and glass surfaces
- 18 ... 25.7 cm (7 ... 10.1")
- Control and Visu Panel versions

## PFC200 XTR Controllers



- The advantages of WAGO's PFC Controllers combined with capabilities for extreme environments:
- High processing speed
- Multiple interfaces
- Extremely robust and maintenance-free

## WAGO I/O System – 750/753 Series



- Highly versatile
- More than 500 modules available
- Functional safety
- Ex i

## Power supplies



6

### Runtime software

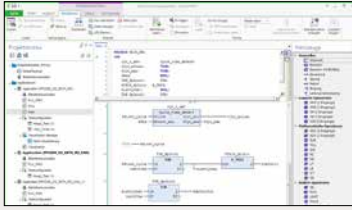

- Fixed machine component
- Comprehensive, tested software modules for control, regulation, operation & monitoring

### Touch Panel 600 Marine Line



- High-performance touch panels with resistive touchscreens
- Ideal for shipbuilding applications
- 10.9 ... 25.7 cm (4.3 ... 10.1")
- Visu Panel versions

### 750 Series Controllers



- Controllers for all common fieldbus systems
- Programmable per IEC 61131-3
- Ideal combination with the modules of the WAGO I/O System 750

### WAGO I/O System – 750 Series XTR

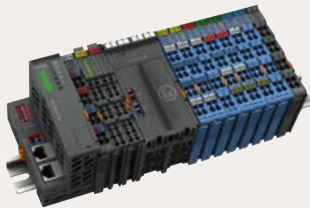

- For demanding applications where the following are critical:
- Extreme temperature resistance
  - Immunity to electromagnetic interference and impulse voltages
  - Vibration and shock resistance

### Sensor/actuator boxes



- M8 and M12 sensor/actuator boxes
- Passive signal acquisition/output at the machine level
- Fully encapsulated

### Mobile software (apps)



- Machine operation and monitoring on tablet and smartphone

### Touch Panel e!DISPLAY 7300T



- Touch panels with resistive touchscreens
- 10.9 ... 25.7 cm (4.3 ... 10.1")
- Versions include Web Panel for display of CODESYS V2 or e!COCKPIT visualizations

### 750 XTR Series Controllers



- For demanding applications where the following are critical:
- Extreme temperature resistance
  - Immunity to electromagnetic interference and impulse voltages
  - Vibration and shock resistance

### WAGO I/O System Field – 765 Series



- The WAGO I/O System Field for cabinet-free automation with IP67 protection type features an impressive range of functions:
- Efficient power supply
  - High-performance fieldbus modules
  - Flexible installation
  - IP67 housing

### Radio technology



- Bluetooth®
- WLAN
- EnOcean®

### Solutions

Cloud solutions  
Software applications

### Software

Engineering software  
Runtime software  
Mobile software (apps)

### Operation and Monitoring

Touch Panel 600 Standard Line  
Touch Panel 600 Advanced Line  
Touch Panel 600 Marine Line  
Touch Panel e!DISPLAY 7300T

### Controllers

Touch Panel 600 Standard Line  
Touch Panel 600 Advanced Line

PFC100/PFC200 Controllers  
PFC200 XTR Controllers  
750 Controllers  
750 XTR Controllers

### I/O Systems

763, 768, 750 and 753 Series  
Fieldbus couplers  
Digital input/output modules  
Analog input/output modules  
Function/technology modules  
Communication modules  
Functional safety  
Intrinsically safe modules  
Supply and segment modules

### 763 Series Advanced

### 750 XTR Series

### 765 Series Field

### Infrastructure

Industrial switches

Power supplies

Sensor/actuator boxes

Radio technology

## WAGO Cloud

### Collect, Analyze and Manage Data Centrally

WAGO Cloud gives you the option of collecting data from various machines and managing it centrally.

WAGO Cloud makes it possible to manage and monitor WAGO's controllers, including their data and applications. It is hosted on Microsoft's Azure Cloud. With simple, user-friendly operation, it was developed so that even people without IT experience can use it.

The cloud service is available online at <https://cloud.wago.com/>. After registering for free and linking to the WAGO Controllers, you can get started in just a few minutes.

### How does machine data get to WAGO Cloud?

A WAGO PFC Controller or Touch Panel serves as a gateway, collects the data and then sends it to WAGO Cloud. Users log into their user interface on the Web portal to use various applications and access functions like visualizations, controller and user management and status monitoring. They can also activate alarm functions and use them to automatically send email notifications if defined limit values are exceeded, for example. Data can be graphically visualized, evaluated and exported as needed.

### Do you need to restrict and select what data is sent to the cloud?

No problem! You decide yourself by configuring the WAGO PFC Controller, specifying what data to send to the cloud or not via IEC program.

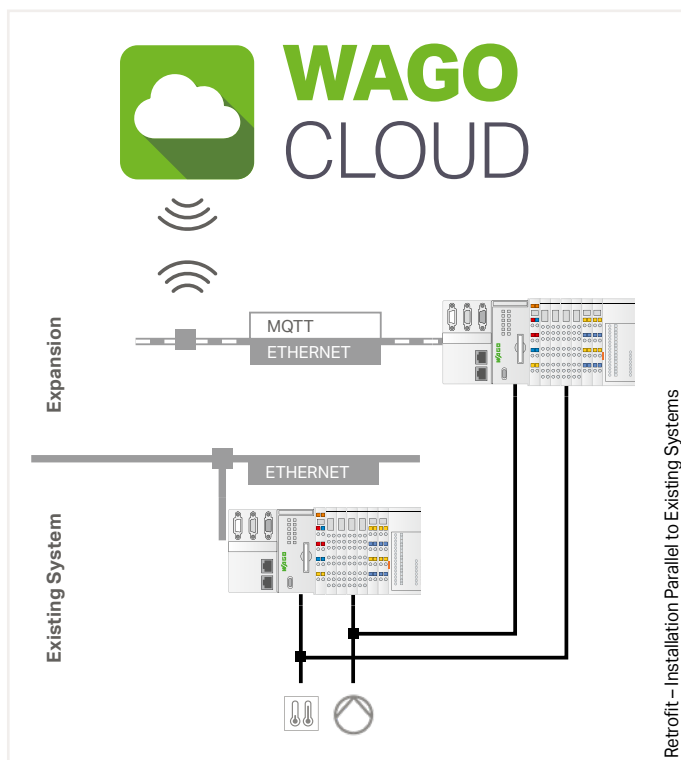

Retrofit – Installation Parallel to Existing Systems



Installation of a New System

Figures: Data Transfer to WAGO Cloud

The WAGO PFC Controller functions as a gateway for existing systems. It extends existing systems easily. It collects the data through various protocols and transports it to WAGO Cloud via the TLS-encrypted MQTT connection. If the system is newly installed and the WAGO PFC Controller is used, it can send the data directly to the cloud.

### What advantages does WAGO Cloud offer?

#### • Simplicity

The solution is intuitive thanks to a clear range of functions. Within minutes, you can send data to the cloud, without extensive IT expertise.

#### • Flexibility

Customize your cloud solution at any time and from any place. For instance, you can double your number of controllers from one day to the next without affecting performance and availability. Would you like a special expansion? We offer that as a project service through customized cloud-expansions.

#### • Everything from a single source

Take advantage of the benefits of WAGO Cloud – a software as a service distribution model. Save time by leaving the tasks of infrastructure, security platform and application management to WAGO.

# WAGO Cloud

### App overview:

All functions at a glance thanks to an intuitive app structure

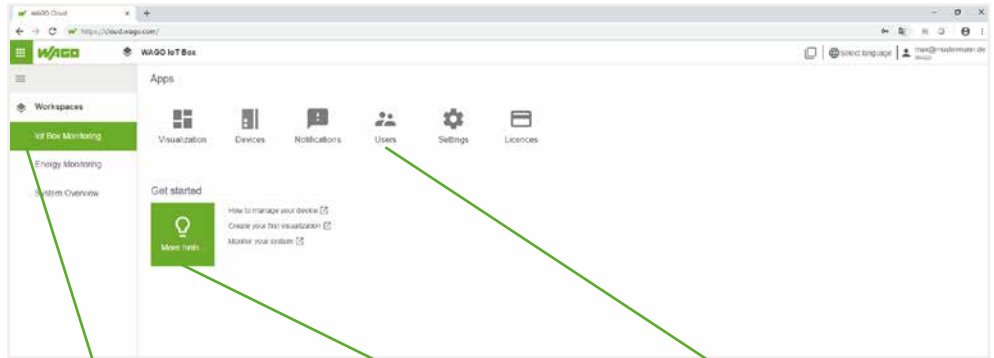

### Quick access:

- Quickly discover what you are looking for – you have all your workspaces in view.

### Easy to use:

- Let us guide you in creating cloud projects.

### Relevant functions:

- Only see the features that you have access to.

### Controller status overview:

See your connected and unconnected controllers, as well as relevant connection details.

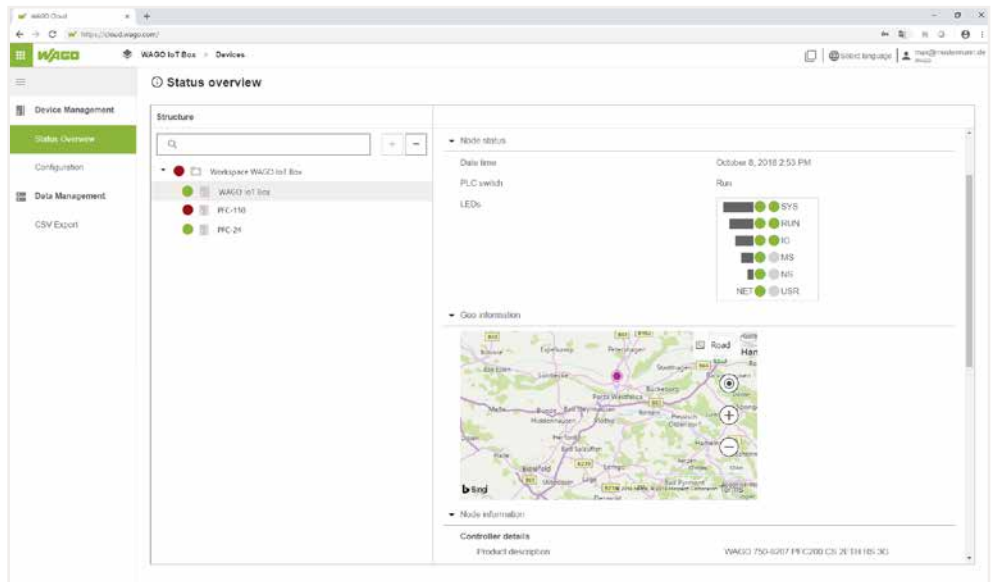

### Dashboard:

Create your own dashboard catered to your needs and use graphics and trends.

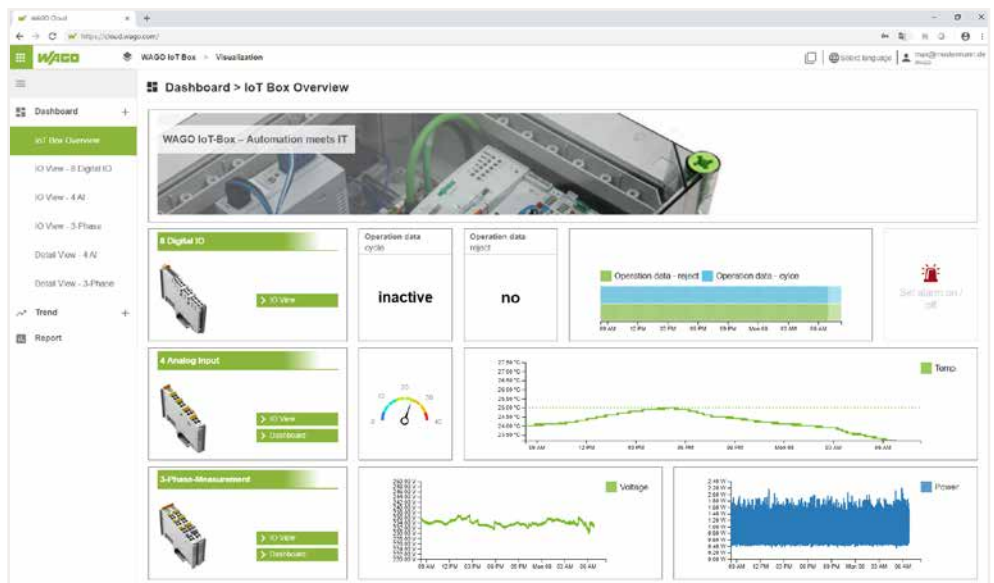

## WAGO Cloud

### What kind of services can I use on WAGO Cloud?

WAGO Cloud is a universal, industrial-strength data logger with data visualization. It allows customizable dashboards and analyses to be created quickly and easily in the cloud. Use interfaces via REST and CSV data export for further processing of data, or use them as a data supplier to perform detailed analyses in other systems, for example. Monitor controller statuses and receive notifications if specified limit values are exceeded.

### How can I use the functions?

Try WAGO Cloud for 30 days with no commitment to see if it's right for you.

The cloud service is available online at <https://cloud.wago.com/>. After registering for free and linking to the WAGO controllers, you can get started in just a few minutes.

After that, you book license points with a prepaid model, via our WAGO eShop for example, and simply redeem them in the cloud. Transparent billing management in the cloud allows you to fully monitor the current and anticipated scope of the functions used. When your license points are almost depleted, you will receive a notice to reload points account soon.

You can find an overview of the functions we currently offer in the following table. There are various tiers for each individual function – depending on how many components you need – such as the number of connected controllers.

Trial Period		<ul style="list-style-type: none"> <li>Try WAGO Cloud for free for 30 days (limited test points).</li> <li>You can continue to use the points balance by activating license points.</li> </ul>	
Functions			
Data Management	Data Package	<ul style="list-style-type: none"> <li>Connect WAGO PFC Controllers to the cloud.</li> <li>Transfer data from the controller to the cloud.</li> <li>Mount devices and data.</li> <li>Visualize data.</li> </ul>	<ul style="list-style-type: none"> <li>Basic package, required for use of WAGO Cloud</li> <li>Minimum purchase: 50 license points/month</li> <li>Volume-dependent, decreasing license point consumption</li> </ul>
	Restful API	<ul style="list-style-type: none"> <li>Provide data for other cloud services and customer systems.</li> </ul>	<ul style="list-style-type: none"> <li>Volume-dependent, decreasing license point consumption</li> </ul>
Device Management	Firmware & Application Update	<ul style="list-style-type: none"> <li>Select/download firmware catalog.</li> <li>Manage your own firmware application catalog.</li> <li>Replace firmware on the device.</li> <li>Install application updates.</li> </ul>	<ul style="list-style-type: none"> <li>1 license point/update</li> </ul>
	Remote Visu Access	<ul style="list-style-type: none"> <li>Access local configurations and visualizations remotely (diagnostics, monitoring and remote maintenance).</li> </ul>	<ul style="list-style-type: none"> <li>2 license points/hour</li> </ul>

Item Description	Item No.
WAGO Cloud; 100 license points	2759-1061/651-010
WAGO Cloud; 500 license points	2759-1061/651-050
WAGO Cloud; 1000 license points	2759-1061/651-100

Redeem license points at: <https://cloud.wago.com/>



## Cloud Connectivity via MQTT

Besides software, we also supply the right hardware:  
PFC Controllers and WAGO Touch Panels 600 with cloud connectivity

Recording, digitizing and linking data profitably – these are the core ideas of Industry 4.0. Field level connection is established with the open WAGO I/O System 750, 750 XTR or Advanced, and a WAGO PFC Controller or Touch Panel 600 sends data to the cloud or a local MQTT broker. Once in the cloud, data can be aggregated and used for analysis. This capability creates tremendous added value for your company – whether it's increasing the efficiency of in-house production, implementing energy management in buildings or developing additional end-customer services.

### Future-Proof

Existing systems also become IoT-ready, making them future-proof. Communication between PFC Controllers and cloud suppliers offers via the MQTT protocol and encrypted via TLS 1.2. Cloud connection data is configured via Web-Based Management (WBM). WAGO e!COCKPIT Engineering Software includes appropriate libraries for specifying the variables for transfer to the cloud in the PLC program, allowing the PLC programmer to maintain complete control. Controller information, such as run/stop, connection status and device information, can also be transferred to a cloud solution via cloud connectivity or distributed by an MQTT broker.

### Interfaces

With a wide variety of interfaces, WAGO's controllers also provide the perfect foundation for an IoT gateway. They can collect numerous field signals, communicate in many industrial protocols and even enable cloud connection of sensors and actuators that themselves have no Web interface. Thanks to the standardized MQTT protocol, it is possible to connect to cloud providers such as Microsoft Azure, Amazon Web Services, IBM Cloud and SAP Cloud. Of course, other MQTT brokers or solutions like WAGO Cloud can also be connected. Cloud connectivity has been a standard feature of the PFC Controllers since firmware version V11; the required library is included in e!COCKPIT from version V1.4 onward. With firmware version V12 and higher, WAGO's Touch Panels 600 supply the connection; from version V1.5 on, e!COCKPIT contains the required libraries.

### Your Benefits:

- Direct connection between the field level and the cloud
- Expansion of existing systems with the PFC and control panel as an IoT gateway
- Distributed data acquisition and visualization from anywhere
- Connection to Microsoft Azure, Amazon Web Services, IBM Cloud or other MQTT brokers via standardized MQTT protocol
- High level of security thanks to TLS encryption

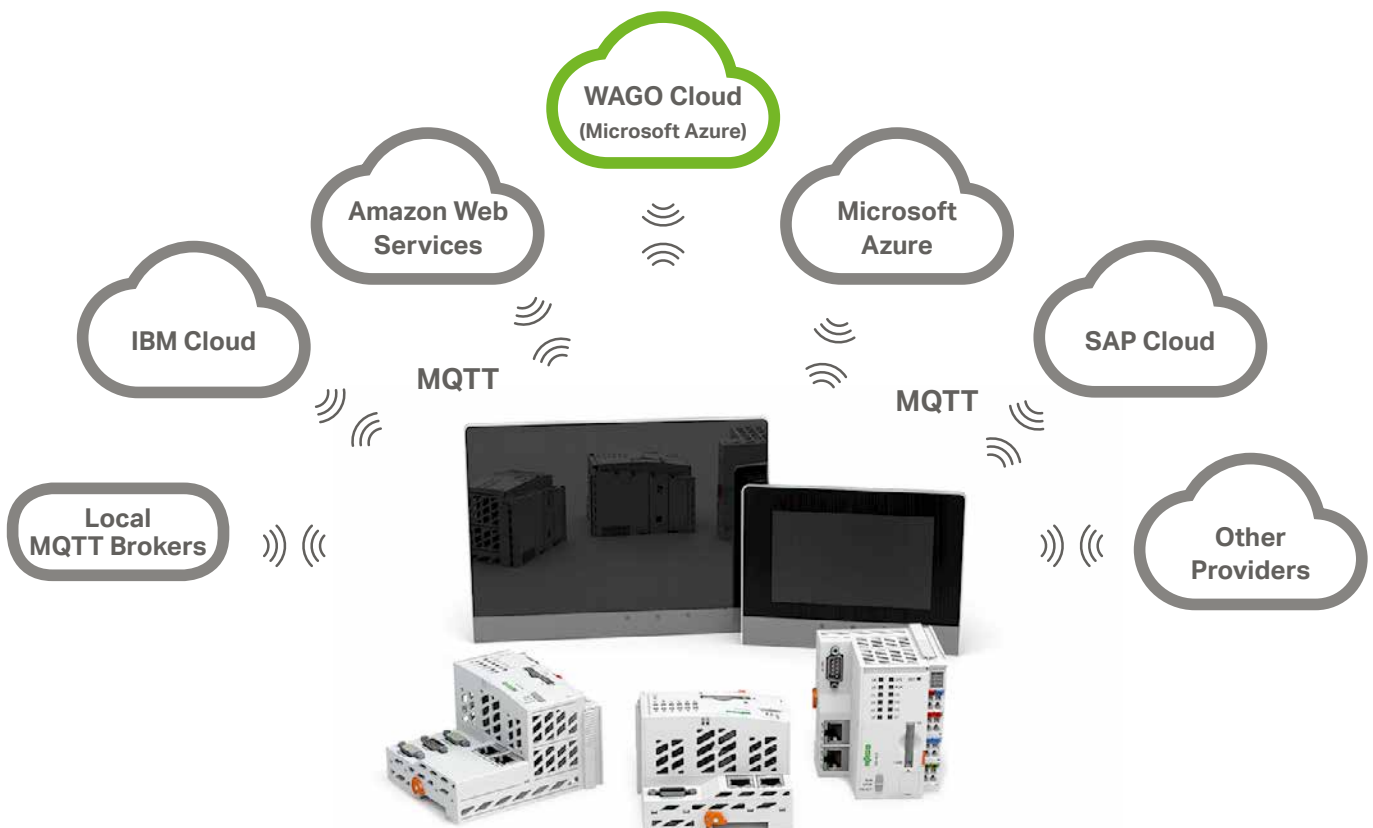

Cloud connectivity is possible with all PFC100 and PFC200 Controllers and Touch Panels 600.

# e!COCKPIT CODESYS V3-Based Engineering Software

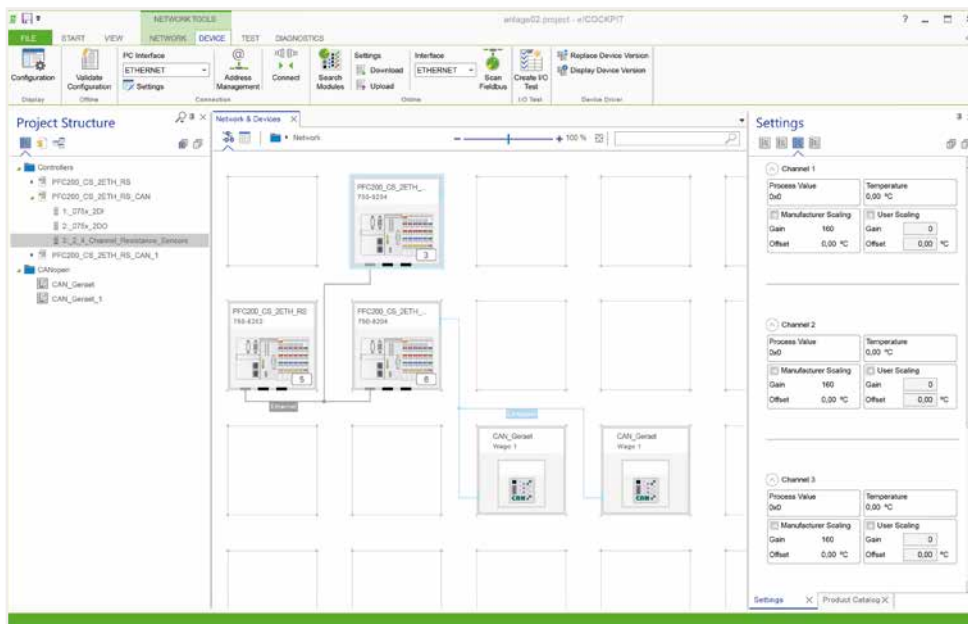

e!COCKPIT automation software for faster machine and system start-up: WAGO's new engineering software shortens development time for automation projects with the compelling advantages of a modern, clearly organized user interface. At the software's core is CODESYS V3 for simple and versatile creation of applications.

WAGO set out to meet these exact requirements by developing its own engineering software: e!COCKPIT. This integrated development environment supports every automation task, from hardware configuration, programming, simulation and visualization, to commissioning – all in one software package.

Ensuring a project's long-term viability through sustainable cost savings hinges on the user's ability to quickly adapt to new software that offers a high degree of reusability.

Use the programming tool to handle all important automation tasks, and implement especially complex projects quickly and easily.

e!COCKPIT					
License Type	Number of PCs	Item No.	Order Text		
Workstation license	2	2759-101/1110-2002	e!COCKPIT; workstation license	Can be installed on up to two computers (e.g., a notebook & desktop)	
Multi-user license	5	2759-101/1110-2005	e!COCKPIT; multi-user license; 5	Multiple installations up to specified number	
Multi-user license	10	2759-101/1110-2010	e!COCKPIT; multi-user license; 10		
Multi-user license	15	2759-101/1110-2015	e!COCKPIT; multi-user license; 15		
Multi-user license	20	2759-101/1110-2020	e!COCKPIT; multi-user license; 20		
Site license	Unlimited	2759-101/1110-3000	e!COCKPIT; site license	Unlimited number of installations at one location within a company	
Buy-out license	Unlimited	2759-101/1110-4000	e!COCKPIT; buy-out license	Unlimited number of installations within a company at all locations within this country; in addition, the software may be used in company products that contain WAGO's automation technology and form a functional unit with it.	

Supported Operating Systems	Windows 7 (32- and 64-bit), Windows 8, Windows 8.1 (32- and 64-bit), Windows 10
<b>System Requirements</b>	
Processor	Dual-core
Memory	4 GB
Hard disk space	10 GB
Graphics resolution	1,366 × 768 px
Supported devices	CODESYS V3-based controllers; I/O modules (750/753)
Supported fieldbuses	CANopen; Modbus TCP/UDP; Modbus RTU; PROFIBUS; EtherCAT®
Supported device descriptions	DTP; EDS; GSD
Connectivity	TCP; USB; OPC; CODESYS network variables; CODESYS DataServer; MQTT
Programming languages per IEC 61131-3	ST; LD; FBD; IL; FC; CFC
Import/export formats	CODESYSV3 project files (*.project)
Delivery type	Installation file (download)
For data sheet and additional information, see:	<a href="http://wago.com/ecockpit">wago.com/ecockpit</a>

Internet connection may be required for license activation.

Windows® is a registered trademark of Microsoft Corporation.

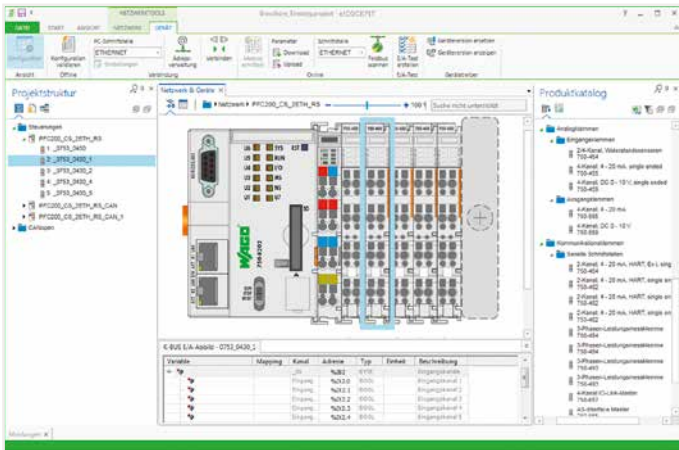

## Configuration and Parameterization

The integrated *e!COCKPIT* configurators provide state-of-the-art operating methods and workspaces, such as:

- Graphical network topology: Complex relationships between network devices and their current states can be identified easily and intuitively.
- Drag & drop: Simplifies device interaction.
- Copy & paste: Individual devices or whole network branches can be duplicated quickly.
- Batch processing: Parameter values are set simultaneously for several devices.

## Programming

*e!COCKPIT* offers extensive software development options:

- IEC 61131-3 PLC programming languages: Structured Text (ST), Ladder Diagram (LD), Function Block Diagram (FBD), Instruction List (IL), Sequential Function Chart (SFC), Continuous Function Chart (CFC)
- For flexibility, all the programming languages can be combined with one another.
- Once created, programs can be easily debugged on the engineering PC via simulation.
- New paradigms such as object-oriented programming are included.

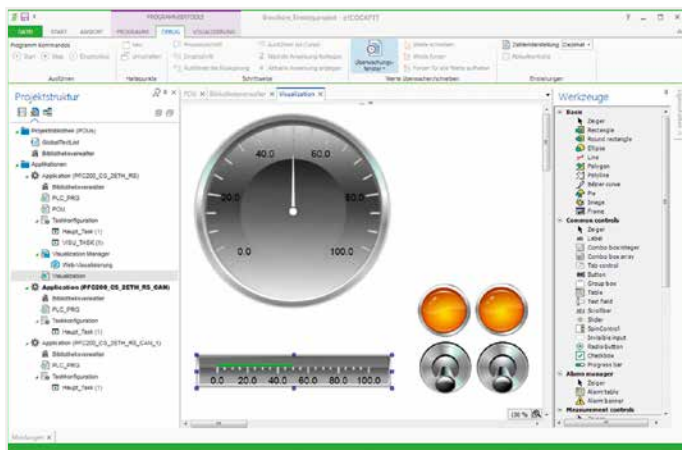
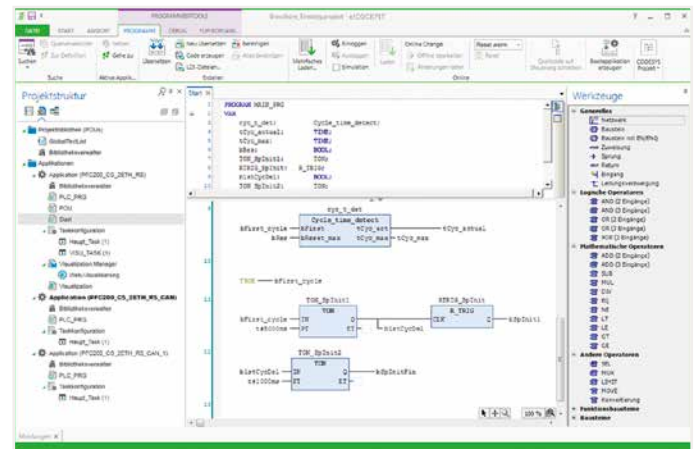

## Visualization

Advanced user interfaces for operating and monitoring machines are standard. Today, HMI-based design is a critical factor that influences the acceptance of an entire automation line. *e!COCKPIT* has drag and drop support to streamline the design of modern user interfaces. The integrated visualization editor provides:

- Access to IEC program variables
- Closed simulation of HMI and PLC programs on the engineering PC
- Guaranteed language independence via Unicode character set
- Current standards such as HTML 5 and CSS

## Diagnostics

Knowing the details of the automation network's current status is an absolute must for the rapid detection and elimination of errors – whether during development in the office, or directly on the machine during commissioning. *e!COCKPIT* provides comprehensive diagnostic capabilities:

- Individual views, for example, always display the controllers' status information both graphically and in tabular form.
- Error messages are transmitted directly and clearly.
- The structured wiring test function systematically identifies wiring errors.

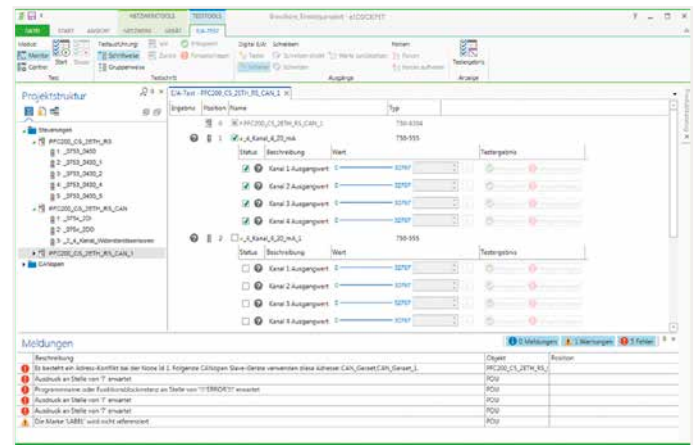

# WAGO I/O PRO; e!COCKPIT CODESYS V2.3-Based Engineer Software and Other Software

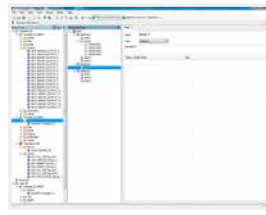
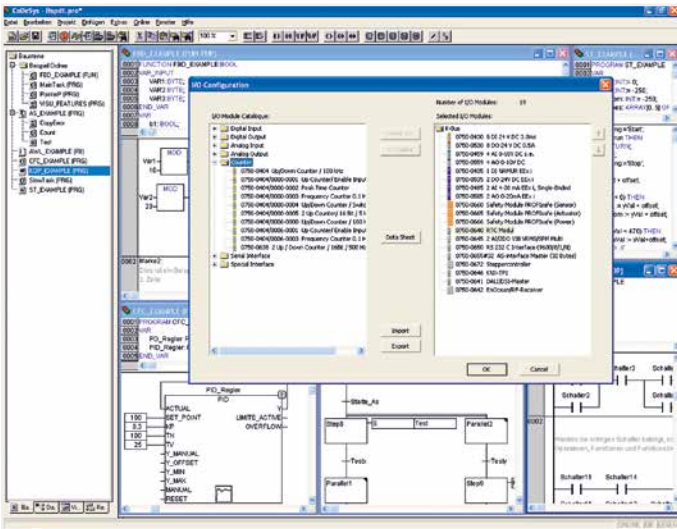

BACnet Configurator



WAGO SMI Configurator

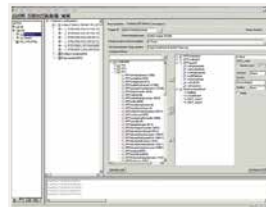

LON® Configurator



DALI Configurator

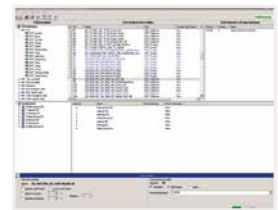

WAGO ETS Plug-in

WAGO-I/O-PRO is a programming and visualization tool for control programs. This software is used to develop PLC applications for WAGO I/O System 750 Controllers.

WAGO-I/O-PRO works according to the IEC 61131-3 standard, which specifies the requirements for a programming system. The IL, SFC, LD, FBD and ST programming languages are supported. The optimal programming language can be chosen for each application.

With extensive programming functions, the software readily meets the increasing demands on control program development, e.g., reusability and modularization.

- Efficient translation between programming languages
- Automatic variable declaration
- Library management
- Integrated test and diagnostic functions also streamline and accelerate the steps for implementing PLC projects.
- Online status display using the program code
- Offline simulation
- Integrated process visualization
- Record and graphically display project variables

WAGO-I/O-PRO also offers the option of programming existing products from other manufacturers within the CODESYS automation alliance in addition to the standard programmable CODESYS automation alliance products from WAGO.

WAGO-I/O-PRO		
Version	Delivery type	Item No.
RS-232 set	CD-ROM and serial communication cable	759-333
USB set	CD-ROM and USB communication cable	759-333/000-923

Supported Operating Systems	Windows 7; Windows 10
<b>System Requirements</b>	
Processor	1 GHz or higher; 32-bit (x86) or 64-bit (x64)
Memory	Min. 1 GB of RAM
Hard disk space	Min. 300 MB
Graphics resolution	Min. 1024 x 786
Other system requirements	Open serial interface, CD-ROM and mouse required
Delivery type	Installation file (CD-ROM)
Data sheet and additional information, see:	<a href="http://wago.com/759-333">wago.com/759-333</a>

Windows® is a registered trademark of Microsoft Corporation.

**WAGO SMI Configurator**  
Download: [www.wago.com](http://www.wago.com)

**BACnet Configurator**  
The BACnet Configurator can be downloaded for free.  
See: [www.wago.com](http://www.wago.com)

**DALI Configurator**  
The DALI Configurator is available as part of WAGO-I/O-CHECK (Version 3.5.1 or higher) or as a stand-alone version ([www.wago.com](http://www.wago.com)).

**LON® configurator**  
LON® Configurator is available as part of WAGO-I/O-PRO (version 2.3.9.34 or higher)

**WAGO ETS Plug-In**  
The WAGO ETS plug-in can be downloaded for free.  
See: [www.wago.com](http://www.wago.com)

# WAGO-I/O-CHECK

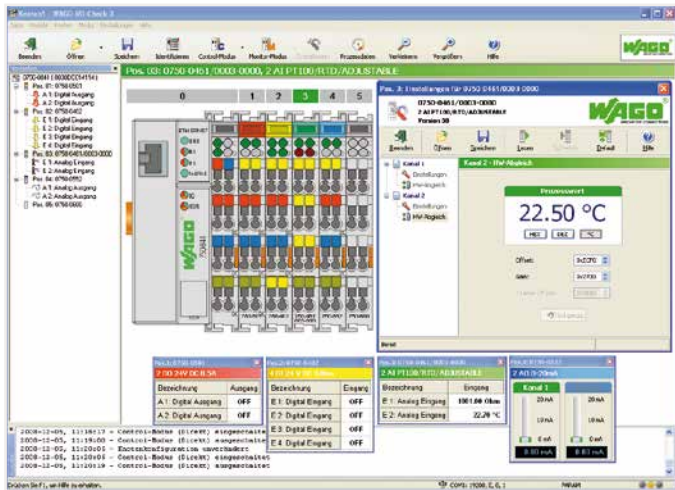

WAGO-I/O-CHECK is an easy-to-use Windows application for checking inputs and outputs and for displaying a WAGO I/O System 750 node, without having to be connected to the fieldbus system at the time. The software reads the configuration from the node and displays it graphically on the screen. This graphic can be printed together with a configuration list as documentation.

With WAGO-I/O-CHECK, it is possible to display and specify the process data of the I/O modules. The field wiring, including all sensors and actuators, can thus be checked before commissioning.

For certain interface modules, Pt100 modules and thermocouple modules, application-specific settings can be made, such as the baud rate or sensor types.

The coupler must be connected to a free serial or USB port of the PC using the communication cable supplied in the set with the system to enable communication between WAGO-I/O-CHECK and the coupler.

WAGO-I/O-CHECK		
Version	Delivery type	Item No.
RS-232 set	CD-ROM and serial communication cable	759-302
USB set	CD-ROM and USB communication cable	759-302/000-923
CD	CD-ROM	759-920

Supported Operating Systems	Windows 7; Windows 10
<b>System Requirements</b>	
Processor	1 GHz or higher; 32-bit (x86) or 64-bit (x64)
Memory	Min. 1 GB of RAM
Hard disk space	Min. 150 MB
Graphics resolution	Min. 1024 x 786
Other system requirements	CD-ROM and mouse required
Delivery type	Installation file (CD-ROM)
Data sheet and additional information, see:	<a href="http://wago.com/759-302">wago.com/759-302</a>

# WAGO WebVisu App; for System Operation/Monitoring



With the WebVisu app, you can visualize Web pages created for WAGO Controllers via e!COCKPIT or CODESYS V2. The app features both automated management and routing capabilities, allowing the website to be simply accessed via URL entry. The system or machine to be monitored can then be operated and monitored at any time on the go. You can define up to 100 controllers for fast, direct access via the URL.

The free WAGO WebVisu app is available in an iOS version for iPhones and iPads in the "Apple Store" and an Android version for smartphones and tablets in the "Google Store."

Note: An overview of the supported WAGO controllers, operating manuals and application notes can be found on our website.

6

## WAGO WebVisu App

Download: [Apple Store](#) or [Google Store](#)

<b>System Requirements</b>	
Operating system	iOS version 10.2 or later, Android version 4.2 or later
Compatibility	iPhone; iPad and iPad Air; Android smartphones and tablets

For additional information, see:

[www.wago.com/webvisu](http://www.wago.com/webvisu)



QR Code for WebVisu App

Simply scan the QR code with your mobile device, and you will automatically be directed to the WebVisu app in "Apple Store" or "Google Play™."

Trademarks

Apple, the Apple logo, iPhone, iPad and iPod touch are registered trademarks of Apple Inc. registered in the USA and other countries. "App Store" is a service mark of Apple Inc.

"Google Play™" is a registered trademark of Google Inc.

## RTU (Remote Transmission Unit) for Telecontrol Technology



The WAGO RTU solutions use the modular WAGO I/O System, which has a long-standing record of success, as the platform. This is why the controllers, with scalable performance, have been expanded with special telecontrol protocols (IEC 61850, IEC 60870, DNP3 and Modbus®). In combination with the option of IEC 611-3 programming, this allows all tasks – both telecontrol communication tasks and station automation tasks – to be handled flexibly and, above all, easily.

International approvals guarantee continuous operation under the most challenging environmental conditions. The Linux® operating system ensures maximum flexibility along with long-term availability of the automation solution, taking into account the strictest security requirements for critical infrastructure applications.

The system's flexible communication and programming properties, combined with a comprehensive portfolio of I/O interfaces and programming libraries, result in unparalleled openness for automating solutions across industries. Particularly for electrical distribution networks, water resource management, oil and gas and infrastructure projects.

6

### RTU (Remote Terminal Unit)

Robust and highly tolerant are the key characteristics of the WAGO Remote Terminal Unit (RTU) for telecontrol technology. Whether temperature fluctuations, vibrations, shocks or electromagnetic interference – retrofit telecontrol technology according to your needs and requirements. The WAGO Remote Terminal Unit (RTU) is ready for standard applications or extreme uses.

### WAGO Telecontrol Technology Products

The telecontrol technology controllers from the powerful 750-890 line are compact controllers that can be programmed with CODESYS V2.3 and configured for telecontrol applications. The lean operating system offers an excellent price-performance ratio.

The PFC200 performance class contains devices that can be programmed and configured with CODESYS V2.3 or with *e!COCKPIT* (CODESYS V3-based). That makes them an excellent choice for future-proof migration solutions.

The Linux® operating system makes it possible to implement comprehensive cybersecurity measures or use your own Linux® MicroServices or IoT connections with the PFC200.

### WAGO Telecontrol Technology Configurators

With the WAGO telecontrol technology configurators, objects are set up for the corresponding protocol standard, and data exchange is configured for the remote terminal unit (RTU) or I/O module application.

There are numerous telecontrol protocols, but there are only three standardized higher-level network protocols: IEC 60870, IEC 61580 and DNP 3. The WAGO remote terminal unit (RTU) can speak all three. With configurators, telecontrol systems can be connected to the corresponding central SCADA system quickly and easily. An open interface is a compelling advantage of the fieldbus-independent WAGO Remote Terminal Unit (RTU), which can be used worldwide for infrastructure automation communication.

WAGO telecontrol technology supports the following telecontrol protocols: IEC 60870-5-101 for serial transmission and IEC 60870-5-104 for TCP/IP-based communication. Within these signal-oriented protocols, messages, measurement values, bit patterns, counter values and (setting) commands are exchanged – each with or without a time stamp.

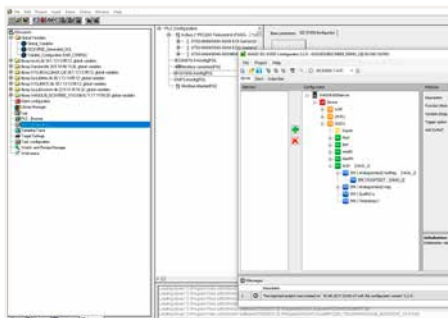

CODESYS Configuration Dialog

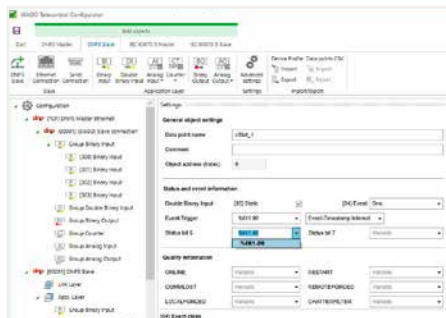

Standalone Tool Configuration Dialog

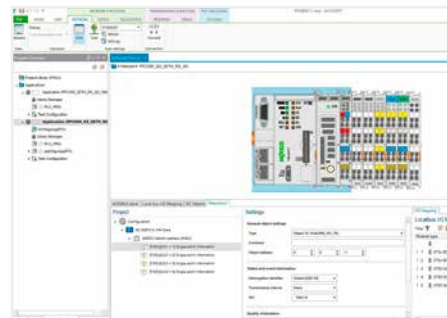
*e!COCKPIT* Configuration Dialog

For more information, see [www.wago.com](http://www.wago.com)

# RTU (Remote Transmission Unit) for Telecontrol Technology

## Telecontrol Technology Protocols

### IEC 60870

- IEC 60870-5-101-, -104 Server
- IEC 60870 -5-103-, -1011-, -1041 Client
- 1 ... 4 multi-client or multi-link client connections per server
- IP address filter (whitelist)
- 1 ... 16 ASDU addresses, configurable
- Scalable telegram length: 64 ... 253 bytes
- Freely configurable platform with up to 2,000 objects per station
- Direct execution of commands or selection and execution ("Select before Operate")
- Command lock for single and double commands and aging management
- Support for count value modes A ... D
- Optional command responses for single and double commands
- 8 ... 128/2562 kB of historical data (remanent data storage on SD card)
- Function for import/export of data set in CSV format
- Time synchronization via NTP, Object 103, DCF1
- KEMA (GL\_DNV) certified

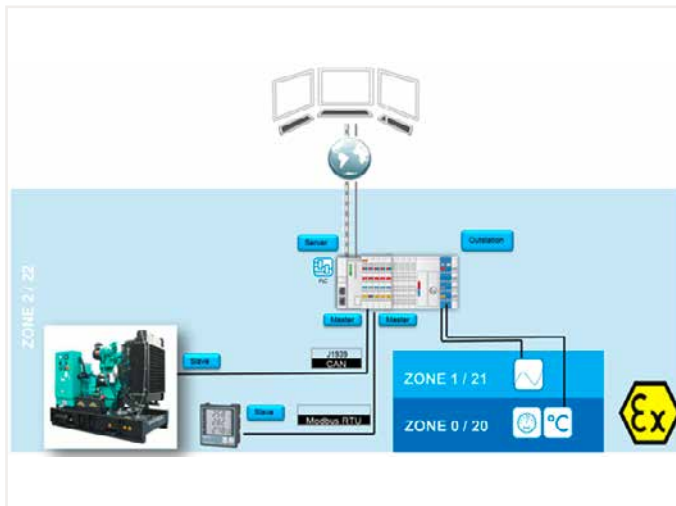
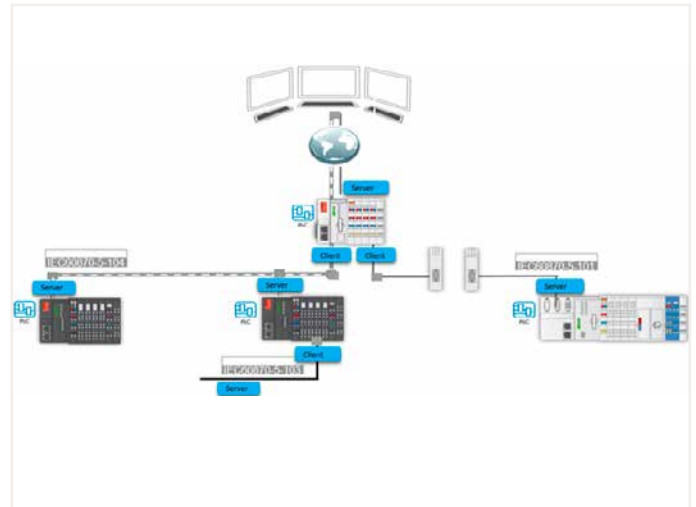

### DNP3

- DNP Outstation (Server)
- DNP3 Master (Client)
- 1 ... 4 master connections, freely configurable for ETHERNET and serial interface
- IP address filter (whitelist) for ETHERNET connections
- Event buffer (< 32,000 events)
- Remanent event buffer (< 100,000 events) on SD card
- Freely configurable platform with up to 2,000 objects per station
- Scalable start index for object groups
- Scalable hysteresis of the master's analog inputs (object group 34)
- 8/16-bit configurable object qualifier
- Unsolicited messages (modes A ... E)
- Protocol conformity via www.dnp.org
- DNP3 Secure Authentication
- Export via "Device Profile Description"

### IEC 618501

- IEC 61850 MMS Server and Client
- 61850 and 61400-25 Server Edition 1 and Edition 2
- 1 server with up to 20 LDs in a station
- Data sets, buffers and unbuffered reports
- GOOSE publisher and subscriber
- Max. 20 data sets with max. 50 objects for each LD
- Max. 20 RCBs for each LD
- Max. 20 server connections for the client
- Max. 96 read requests for all servers
- External reference to the GOOSE subscriber in the LN
- Free extension of the data model by means of own LN
- Supported input formats: ICD, SCD, SSD and CID files
- Supported export formats: ICD and CID files
- TÜV-certified

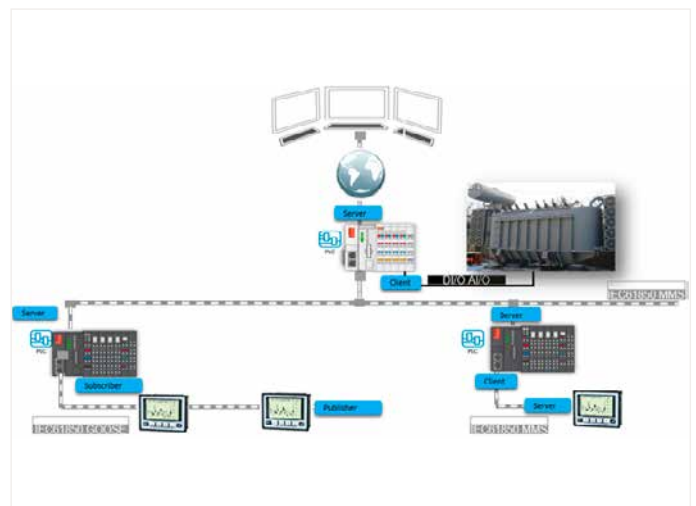

Configuration of Telecontrol Technology Protocols		CODESYS V2.3	e!COCKPIT
IEC 60870	Server (slave)	-101; -104	-101; -104
	Client (master)	-101; -103; -104	-103
DNP3	Server (slave)	TCP and serial	TCP and serial
	Client (master)		TCP and serial
IEC 61850	Server (slave)	x	
	Client (master)	x	
	GOOSE	Publisher and subscriber	

Different configurations of the communication protocols are available depending on the engineering environment. Protocols can also be combined with each other (within the system limits), for instance in order to implement various gateway functions.

### Your Benefits:

- Versatile communication interfaces
- Streamlined usage and low life-cycle costing
- Approvals for harsh substation conditions
- Guaranteed system availability and data integrity thanks to high cybersecurity

## WAGO Lighting Management

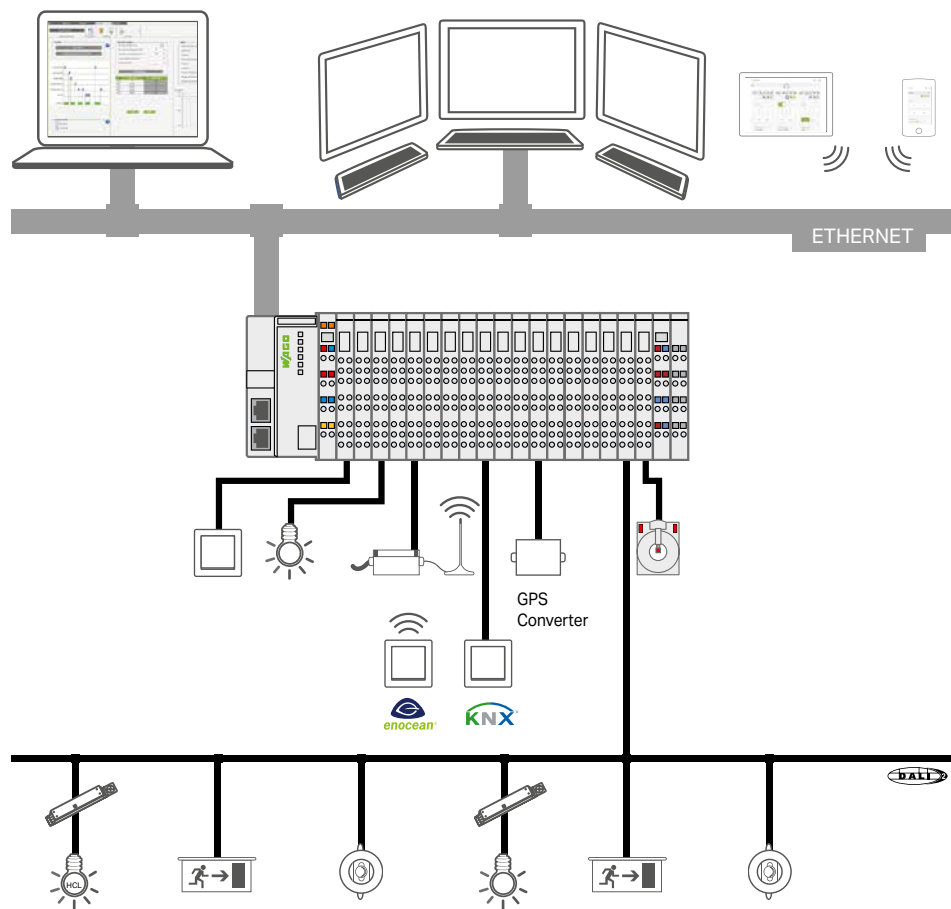

6

WAGO Lighting Management is a proven solution based on predefined hardware and preconfigured software, which greatly simplifies planning, commissioning and operation.

The basic idea: WAGO Lighting Management is oriented toward the different lighting requirements that apply in warehouses and production facilities. For this purpose, a production facility is divided into different areas known as "virtual rooms" in which the light can be controlled and regulated according to the requirements on this area. Each virtual room can be flexibly and uniquely tailored to the sensors, actuators and functions used. By using the virtual rooms, conversions and room remodeling can be implemented quickly and easily via Web configuration.

A separate HTML5 user interface is available for convenient and intuitive operation of WAGO Lighting Management. Operation is optimized for display on different terminal devices, such as tablets, smartphones and touch panels.



### The Benefit for You:

- Configuring – not programming
- Reduced commissioning time
- Comprehensive control functions, e.g. daylight control, time functions, Human Centric Lighting (HCL), constant light control, emergency lighting



For more information, see [www.wago.com](http://www.wago.com)



## WAGO Lighting Management

WAGO Lighting Management			
	Components	Item No.	Note
Base Unit	PFC200 G2 2ETH RS Controller	750-8212	The PFC200 Controller is a compact PLC for the modular WAGO I/O System. Besides network and fieldbus interfaces, the controller supports all analog/digital input modules and analog/digital output modules, as well as specialty modules of the 750/753 Series. The controllers can communicate with each other.
	License for "Lighting Management" application	2759-204/261-1000	Application available at <a href="http://www.wago.com">www.wago.com</a>
	DALI Multi-Master	753-647	In addition to 64 DALI actuators (ECGs), a DALI-Multi Master supports up to 16 DALI-Multi sensors (max. 64 sensor addresses); max. 10 DALI modules per base package.
	End Module	750-600	An end module must be snapped onto the assembly at the end of a fieldbus node.
	Power Supply for I/O Node	787-1012	24 VDC supply voltage for controllers and additional modules
	Power Supply for DALI Multi-Master	787-1007	Supplies a maximum of five DALI Multi-Master modules
Expansion for visualization	Licenses for Lighting Management Visualization	2759-2101/271-1000	Visualization – S
		2759-2102/271-1000	Visualization – M
		2759-2103/271-1000	Visualization – L
Extension for inputs/push-buttons	16-Channel Digital Input; 24 VDC; 3 ms	750-1405	For 1 ... 16 light push-buttons/switch inputs; max. 4 extensions per base package
Extension for outputs/actuators	16-Channel Digital Output; 24 VDC; 0.5 A	750-1504	For 1 ... 16 actuators/lamps/relays/ECG control; max. 2 extensions per base package
	Socket with Relay and Status Indicator; 1 make contact; 24 VDC	788-357	Light switching via relay
Extension for EnOcean Radio	RS-232/-485 Serial Interface	750-652	Serial interface connects to STC65-RS-485 EVC EnOcean radio transmitter/receiver (for 1 ... 64 rocker switches)
	EnOcean Receiver/Transmitter	2852-7101	Receives EnOcean radio signals and transmits them to the I/O node
	EnOcean Repeater	2852-7102	Extends the transmission range (for more planning information, visit the EnOcean website)
	Radio Transmitter; EnOcean easyfit PTM 250; 2-channel lighting controller	758-940/001-000	1 ... 2 or 1 ... 4 signals; range of 30 meters from the radio receiver in buildings
	Radio Transmitter; EnOcean easyfit PTM 250; 4-channel lighting controller	758-940/003-000	1 ... 2 or 1 ... 4 signals; range of 30 meters from the radio receiver in buildings
Extension for external time request	GPS DCF converter	2852-7901	Converter/external receiver for time synchronization
Extension for energy data measurement	3-Phase Power Measurement; 690 VAC	750-495/xxx-xxx	
	Current and Voltage Connections Options	2007-8874; 2007-8877	Pre-assembled terminal block assemblies for easy connection and short-circuiting of current transformers (for current transformers, see section 6)
Extension for KNX push-buttons	KNX/EIB/TP1 Interface	753-646	Connects KNX buttons to the I/O node; max. 1 module per base package
DALI-2 Sensors	DALI Sensor; PD11-BMS-FLAT	2852-7210	LOW BAY sensor for offices (2 ... 5 m)
	DALI Sensor; PD4-BMS-GH	2852-7213	HIGH BAY sensor for warehouses (5 ... 16 m)
	DALI Sensor; PD4N-BMS	2852-7214	MID BAY sensor for open-plan offices, underground garages, entrance halls, production facilities (2 ... 10 m)
	Adapter; AP Assembly Kit IP54; accessories for 2852-7214	2852-7215	Accessories for surface mounting of the PD4N-BMS
	DALI Sensor; MSensor G3 SRC 30 PIR 5DPI WH	2852-7220	LOW BAY sensor for offices (up to 5 m)
	DALI Sensor; MSensor G3 SSM 30 10DPI WH	2852-7221	MID BAY sensor for high-ceiling rooms, e.g., production facilities, underground garages (installation height: 5 ... 10 m)
	DALI Sensor; IR Quattro HD DALI-2	2852-7230	LOW/MID BAY sensor for offices (2.5 ... 10 m)
	DALI Sensor; IR Quattro SLIM XS DALI-2	2852-7231	LOW BAY sensor for offices, slim design (2.5 ... 4 m)
	DALI Sensor; IS3360 MX HIGH BAY DALI-2	2852-7232	HIGH BAY sensor for industrial buildings, circular detection range (4 ... 14 m)
	DALI Sensor; IS345 MX HIGH BAY DALI-2	2852-7233	HIGH BAY sensor for industrial buildings, rectangular detection range (4 ... 14 m)
DALI XC G3 (DALI-2)	2852-7225	Push-button coupler connects 4 conventional push-buttons to DALI	
DALI Sensors	DALI Multi-Sensor Kit	2851-8201	Brightness measurement and motion sensor: Kit connects to a DALI bus system
	DALI Sensor Coupler	2851-8202	Sensor coupler for connecting MULTI-3-CI sensors to DALI
	DALI HIGHBAY ADAPTER + HIGH BAY	2852-7207; 2852-7201	Brightness measurement and motion sensor for large installation heights (3–13 m)
	DALI HIGHBAY ADAPTER + VISION	2852-7207; 2852-7202	Motion sensor for large areas, open offices, hallways or warehouses
	DALI LS/PD LI	2852-7203	Motion sensor for office lighting (1 ... 5 m)
	DALI Sensor Coupler HF LS LI	2852-7205	
	Radar Sensor HF LS LI	2852-7206	Light and recessed ceiling sensor: combined daylight and motion detection; motion detection via radar
	4p4c Connection Cable; 50 cm	2852-7208	
	DALI XC	2852-7301	Push-button coupler connects 4 conventional push-buttons to DALI
DALI Sensor Coupler E	2852-7204	Sensor coupler connects standard sensors to DALI	

## WAGO Energy Data Management

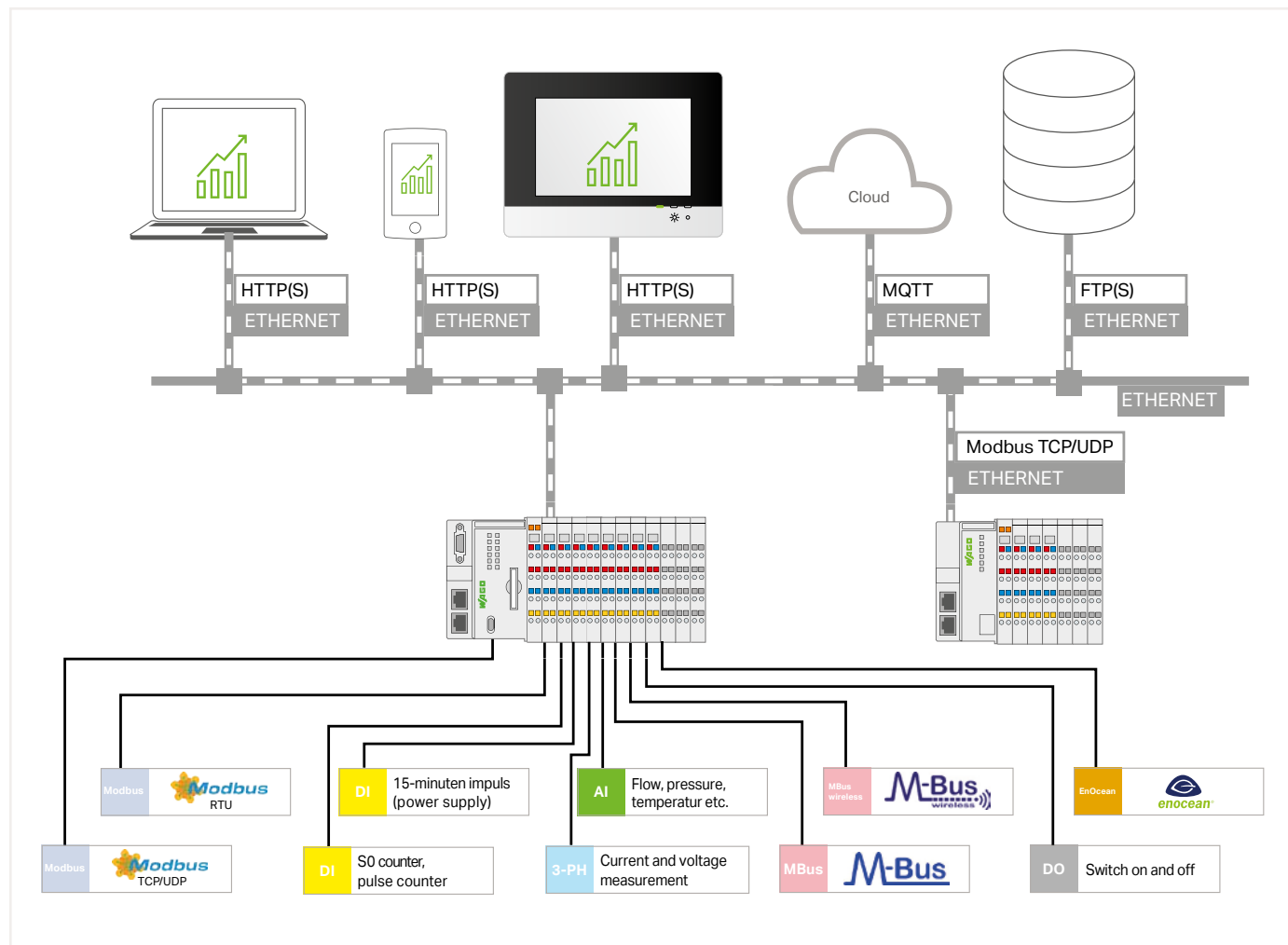

With our energy data management solution, you can record and visualize your measurement data for different media and influencing variables, as well as the key figures calculated from it, in no time. Continuous acquisition and monitoring form the basis for resource-efficient energy usage – the environment will thank you, and your operating costs will be minimized. As an added bonus, conformity with DIN EN 50001 for the energy evaluation is part of the package.

WAGO Energy Data Management consists of Web-based application software combined with a modular control system. It records measurement data for different media and influencing variables for energy monitoring and processes it for further analysis, archiving and reporting. The software automatically detects different signals from the connected meters and sensors, making them available to additional energy analysis tools via simple parameter settings. This allows you to optimize energy consumption in your building or production facility, whether they're local or global.

### The Benefit for You:

- Ready to go in a few easy steps
- No programming experience required
- Integrated cloud connectivity

# WAGO Energy Data Management

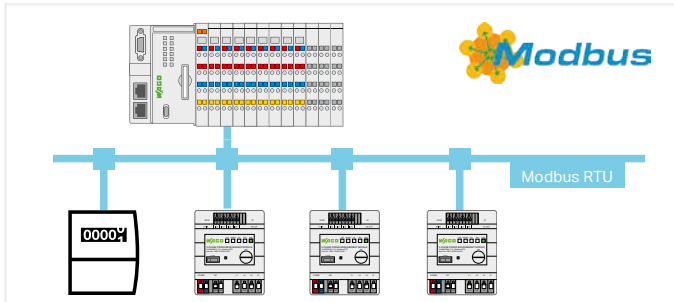

Energy Data Collection with Remote Devices via Modbus RTU

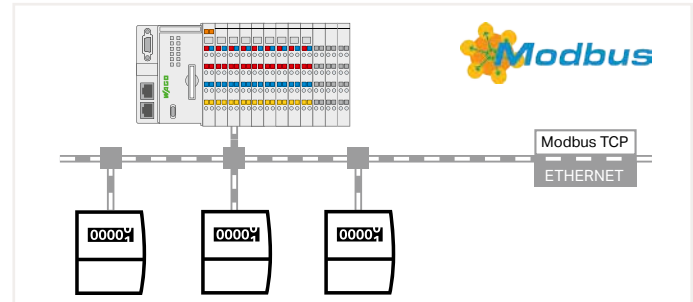

Energy Data Collection with Remote Devices via Modbus TCP

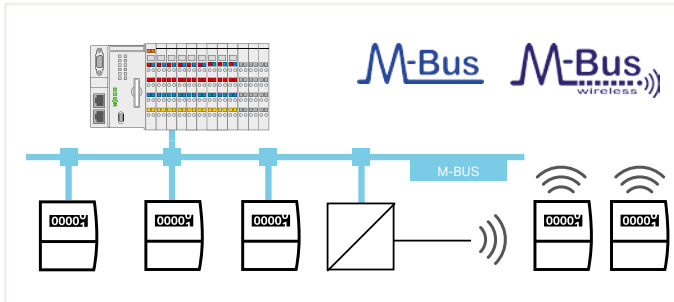

Measured Value Acquisition via M-Bus

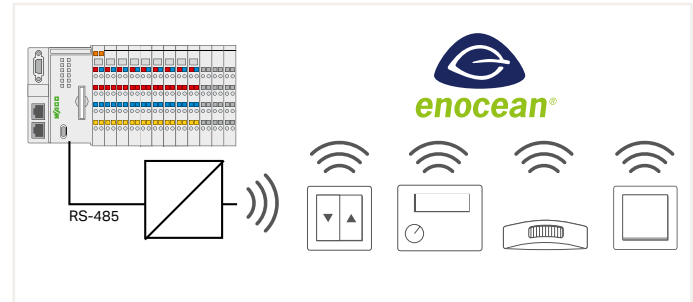

Data Acquisition via EnOcean®

The products listed below are typically used in conjunction with the "Energy Data Management" application. Detailed information about the products, as well as other variants and accessories, can be found in our Full Line Catalog, volume 3 or volume 4.

Energy Data Management		
Required Products	Description	Item No.
<b>Compatible Controllers/Touch Panels</b>		
PFC200 G2	PFC200 Controller as base unit, available in different configurations	750-821x
PFC200 G2 XTR	Alternative: PFC200 for extreme environments	750-821x/000-040
Touch Panel 600 Standard Line; PIO3	Alternative: Touch Panel with resistive touchscreen as basic unit	762-43xx/8000-002
Touch Panel 600 Advanced Line; PIO3	Alternative: Touch Panel with capacitive touchscreen as basic unit	762-53xx/8000-002
<b>Software Licenses</b>		
Energy Data Management Application	License for the "Energy Data Management" application	2759-206/261-1000
„Energy Data Management“ Visualization	Optional: license for the visualization of dashboards and diagrams with responsive design	2759-207/271-1000
WAGO Cloud; 100 license points	Licenses to use WAGO Cloud as a data collector with data visualization; the number of required license points depends on the functions used and the data volume (for details see www.wago.com/cloud).	2759-1061/651-010
WAGO Cloud; 500 license points		2759-1061/651-050
WAGO Cloud; 1000 license points		2759-1061/651-100
<b>Digital Input/Output Modules</b>		
4-Channel Digital Input; 24 VDC; 3 ms	E.g., for recording the PSC effective power pulse	750-402
4-Channel Digital Output; 24 VDC; 0.5 A	E.g., for switching outputs when alarm thresholds are reached	750-504
8-Channel Digital Output; 24 VDC; 0.5 A		750-530
<b>Analog Input/Output Modules</b>		
Recording for temperature, pressure and flow meters and other analog signals		
8-Channel Analog Input; resistance measurement; adjustable		750-451
8-Channel Analog Input; 0/4 ... 20 mA; single-ended		750-496
8-Channel Analog Input; 0 ... 10 VDC/±10 V; single-ended		750-497
2-Channel Analog Input; 0 ... 20 mA; differential input		750-452
4-Channel Analog Input; voltage/current; differential input; electrically isolated channels		750-471
<b>Power Measurement Modules</b>		
<b>Power measurement directly connected to the controller</b>		
3-Phase Power Measurement Module; 480 VAC; 1 A	With split-core or plug-in current transformers	750-494
3-Phase Power Measurement Module; 690 VAC; 1 A	With split-core or plug-in current transformers	750-495
3-Phase Power Measurement Module; 690 VAC; 0.5 A	With split-core or plug-in current transformers	750-495/000-001
3-Phase Power Measurement; 690 VAC; RTC	With Rogowski coils	750-495/000-002
<b>Communication and Technology Modules</b>		
M-Bus Master	Reading in separately recorded meter readings via M-Bus	753-649
RS-232/RS-485 Serial Interface	Reading in data via RS-232 or RS-485 gateways (e.g., EnOcean®)	750-652
2-Channel Up/Down Counter; 24 VDC; 16-bit; 500 Hz	Recording S0 and pulse counter	750-638
<b>Power supplies</b>		
Compact Power Supply; switched-mode; 1-phase	24 VDC output voltage; 2.5 A output current	787-1012
Pro 2 Power Supply; 1- or 3-phase	24 VDC output voltage; 5 ... 40 A output current	2787-2xxx
<b>Distributed Power Measurement Modules</b>		
For distributed energy acquisition via Modbus RTU		
3-Phase Power Measurement Module; input: current transformer, 1 A		2857-570/024-001
3-Phase Power Measurement Module; input: current transformer, 5 A		2857-570/024-005
3-Phase Power Measurement Module; input: Rogowski coil		2857-570/024-000
<b>Gateways</b>		
STC65-RS-485 EVC EnOcean® Receiver/Sender with RS-485 EVC Interface	Gateway for the acquisition of EnOcean® signals	2852-7101

# WAGO Touch Panels Interfaces and Types

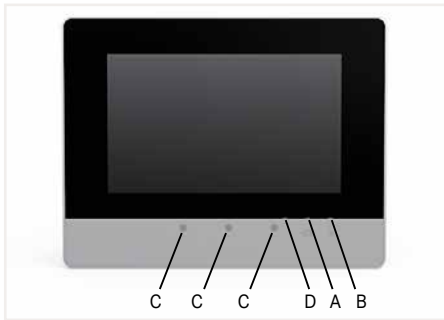

**Touch Panel Standard Line**

By default, the WAGO Touch Panels are equipped with resistive touchscreens. In addition, they have two capacitive buttons (A and B) for on-device brightness settings. A 3-color status LED (D) indicates the device status. An integrated motion and brightness sensor (C) detects when a person is approaching and automatically turns off the screensaver. In addition, it can be used for automatic brightness change (day/night).

Available sizes:

- 10.9 cm (4.3")
- 14.5 cm (5.7")
- 18 cm (7.0")
- 25.7 cm (10.1")
- 39.6 cm (15.6")
- 54.7 cm (21.5")

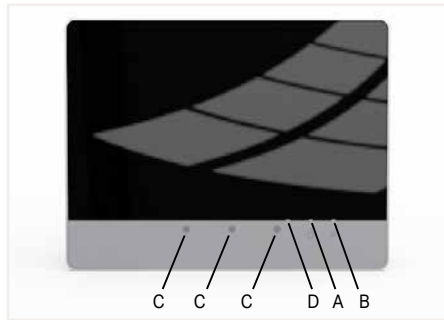

**Touch Panel Advanced Line**

In contrast to the standard version, these devices are equipped with a capacitive touchscreen and a glass surface. This allows gesture recognition, e.g., swiping for turning pages or enlarging. In addition, the glass front exhibits greater mechanical and chemical resistance. Glove operation is also possible.

Available sizes:

- 18 cm (7.0")
- 25.7 cm (10.1")
- 39.6 cm (15.6")
- 54.7 cm (21.5")

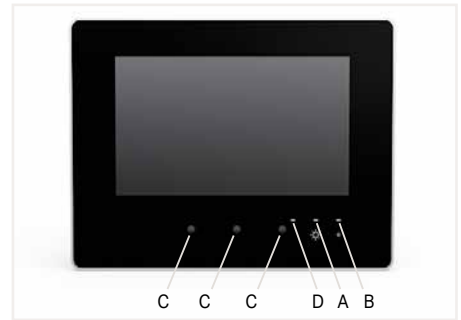

**Touch Panel Marine Line**

This version of the Touch Panels is ideal for shipbuilding applications. It has special marine approvals. The matt black surface prevents annoying glare.

Available sizes:

- 10.9 cm (4.3")
- 14.5 cm (5.7")
- 18 cm (7.0")
- 25.7 cm (10.1")



6

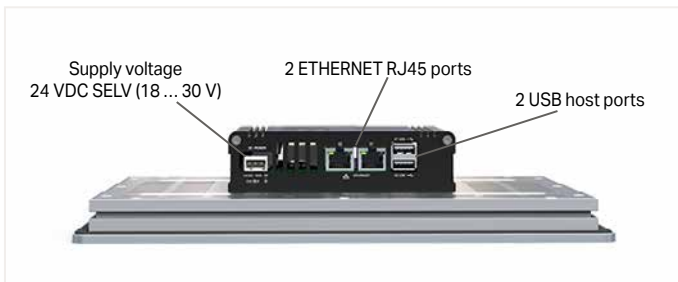

**Web Panel Hardware Configuration**

Besides the power supply connection, devices with this hardware configuration provide:

- 2 ETHERNET ports for connecting to field devices and the engineering tool
- 2 USB ports for optional connection of a USB stick, mouse or keyboard

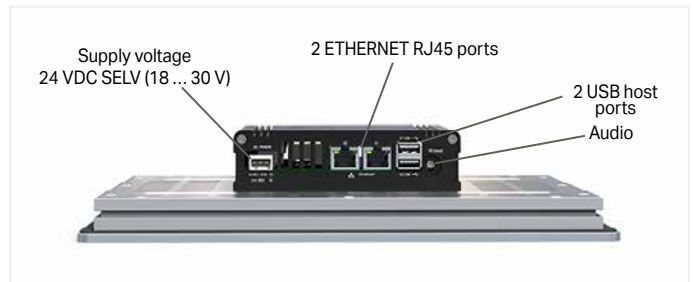

**Visu Panel Hardware Configuration**

This hardware configuration contains the same connections as with the Web Panel. In addition, the devices are equipped with an audio interface for connecting headphones or a loudspeaker.

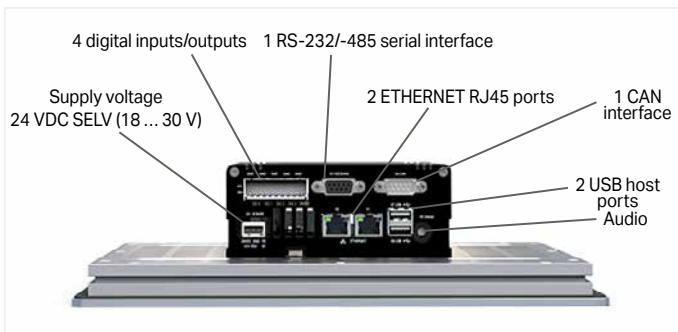

**Control Panel Hardware Configuration**

Besides the interfaces of the Visu panel, control panels also have the following interfaces:

- CAN for controlling field devices
- RS-232/485 interface for controlling field devices with a serial interface
- 4 digital inputs/outputs for reading/triggering digital signals

In addition, this hardware configuration has a rapid, power-failure-proof storage component that can back up retain variables of the controller without additional UPS features.





**Common Control Elements**

The following control elements are provided on the side of the devices:

- Touch Panel 600:**
- Run/stop switch (only relevant for control panels)
  - Service switch
  - 5 LEDs for signaling:
    - General device states
    - Special states of the PLC runtime environment
    - States of the fieldbus connections
  - 1 microSD card for data exchange
- e/DISPLAY Touch Panel:**
- 1 microSD card for data exchange

# WAGO Touch Panel – 762 Series

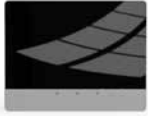
## Product Overview

Figure	Web Browser	Web Visu CODESYS V2	Web Visu e!COCKPIT (HTML5)	Modbus (TCP, UDP)	EtherNet/IP	CANopen	RS-232/-385	IoT Protocols	BACnet (Additional License) EtherCAT® Master (Additional License)	Telecontrol	DNV GL	Screen Size (Diagonal)	Item No.			
													Control Panels	Visu Panel	Web Panel	
<b>Touch Panel 600 Standard Line; CPU: Cortex A9; resistive touchscreen</b>																
	x	x	x	M/S	S	M/S	x	x	x	x	(x)	10.9 cm (4.3")	762-4301/8000-002			
	x	x	x	M/S	S	M/S	x	x	x	x	x	14.5 cm (5.7")	762-4302/8000-002			
	x	x	x	M/S	S	M/S	x	x	x	x	x	18 cm (7.0")	762-4303/8000-002			
	x	x	x	M/S	S	M/S	x	x	x	x	x	25.7 cm (10.1")	762-4304/8000-002			
	x	x	x	(M)					x	x	x	x	39.6 cm (15.6")		762-4305/8000-002	
	x	x	x	(M)					x	x	x	x	54.7 cm (21.5")		762-4306/8000-002	
	x	x	x	(M)								x	10.9 cm (4.3")		762-4201/8000-001	
	x	x	x	(M)								x	14.5 cm (5.7")		762-4202/8000-001	
	x	x	x	(M)								x	18 cm (7.0")		762-4203/8000-001	
	x	x	x	(M)								x	25.7 cm (10.1")		762-4204/8000-001	
	x	x	x	(M)								x	39.6 cm (15.6")		762-4205/8000-001	
	x	x	x	(M)								x	54.7 cm (21.5")		762-4206/8000-001	
	x	x	x									x	10.9 cm (4.3")			762-4101
	x	x	x									x	14.5 cm (5.7")			762-4102
	x	x	x									x	18 cm (7.0")			762-4103
x	x	x									x	25.7 cm (10.1")			762-4104	
<b>Touch Panel 600 Advanced Line; CPU: Cortex A9; capacitive touchscreen with glass surface</b>																
	x	x	x	M/S	S	M/S	x	x	x	x	x	18 cm (7.0")	762-5303/8000-002			
	x	x	x	M/S	S	M/S	x	x	x	x	x	25.7 cm (10.1")	762-5304/8000-002			
		x	x	M/S	S		x	x	x	x	x	x	39.6 cm (15.6")	762-5305/8000-002		
		x	x	M/S	S		x	x	x	x	x	x	54.7 cm (21.5")	762-5306/8000-002		
	x	x	x	(M)								x	18 cm (7.0")		762-5203/8000-001	
	x	x	x	(M)								x	25.7 cm (10.1")		762-5204/8000-001	
	x	x	x	(M)								x	39.6 cm (15.6")		762-5205/8000-001	
	x	x	x	(M)								x	54.7 cm (21.5")		762-5206/8000-001	
<b>Touch Panel 600 Marine Line; CPU: Cortex A9; resistive touchscreen</b>																
	x	x	x	M/S	S	M/S	x	x			x	10.9 cm (4.3")	762-6301/8000-002			
	x	x	x	M/S	S	M/S	x	x			x	14.5 cm (5.7")	762-6302/8000-002			
	x	x	x	M/S	S	M/S	x	x			x	18 cm (7.0")	762-6303/8000-002			
	x	x	x	M/S	S	M/S	x	x			x	25.7 cm (10.1")	762-6304/8000-002			
	x	x	x	(M)						x	x	x	10.9 cm (4.3")		762-6201/8000-001	
	x	x	x	(M)						x	x	x	14.5 cm (5.7")		762-6202/8000-001	
	x	x	x	(M)						x	x	x	18 cm (7.0")		762-6203/8000-001	
x	x	x	(M)						x	x	x	25.7 cm (10.1")		762-6204/8000-001		
<b>e!DISPLAY 7300T Touch Panel; CPU: Cortex A8; resistive touchscreen</b>																
	x	x										10.9 cm (4.3")			762-3000	
	x	x										14.5 cm (5.7")			762-3001	
	x	x										18 cm (7.0")			762-3002	
	x	x										25.7 cm (10.1")			762-3003	

M; Master; S; Slave

### Touch Panel 600 Starter Kit

Figure	Contents	Item No.
	e!COCKPIT starter kit license; WAGO Touch Panel 600 (Advanced Line, Control Panel); aluminum foot (with groove); product board (with recess for 7" Touch Panel); mounting material (clamping element, mounting bracket, M4x8 screws); F/UTP ETHERNET patch cable (1 m); microSD card; operating tool; cable (black/red); 230 V power supply	8003-099/762-5303



Take advantage of the example project provided to get started quickly!

# 750/753 Series WAGO I/O System



IEC 60870-5-101/-103/-104  
IEC 61850  
IEC 61400-25  
DNP3

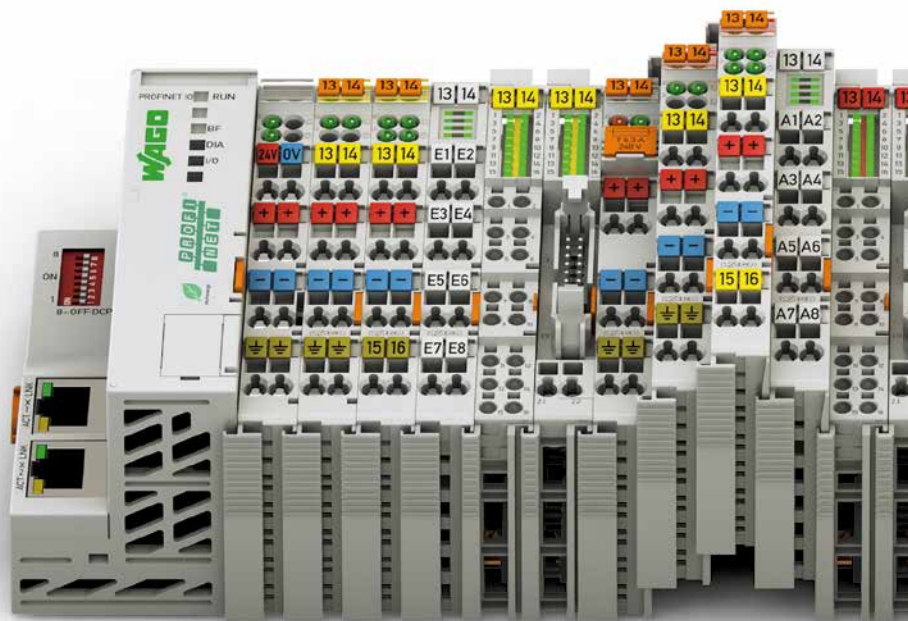

6

### Maximum Fieldbus Independence

The system's modularity is also reflected in its support for numerous fieldbus systems and ETHERNET standards. Depending on the application, it is possible to choose between fieldbus couplers and communication modules for different protocols.

### Worldwide Approvals

International approvals for building and industrial automation, as well as the process and marine industries, guarantee worldwide use – even in harsh operating conditions. These approvals include: ATEX, BR-Ex, IECEx, UL, UL ANSI/ISA and numerous marine certifications.

### Clear Identification

The functionalities of the individual bus modules are identified via (integrated or optional) marker carriers. The terminal assignment and technical data are printed on the side of the bus module. WAGO's WSB Marking System also allows module- and channel-specific identification.

### Extremely Compact

WAGO's patented mechanical design makes extremely compact I/O nodes possible. Up to 16 channels can be accommodated in a 12 mm (1/2") wide housing.

- Highly granular bus modules provide node customization.
- Space-saving design permits high-density wiring

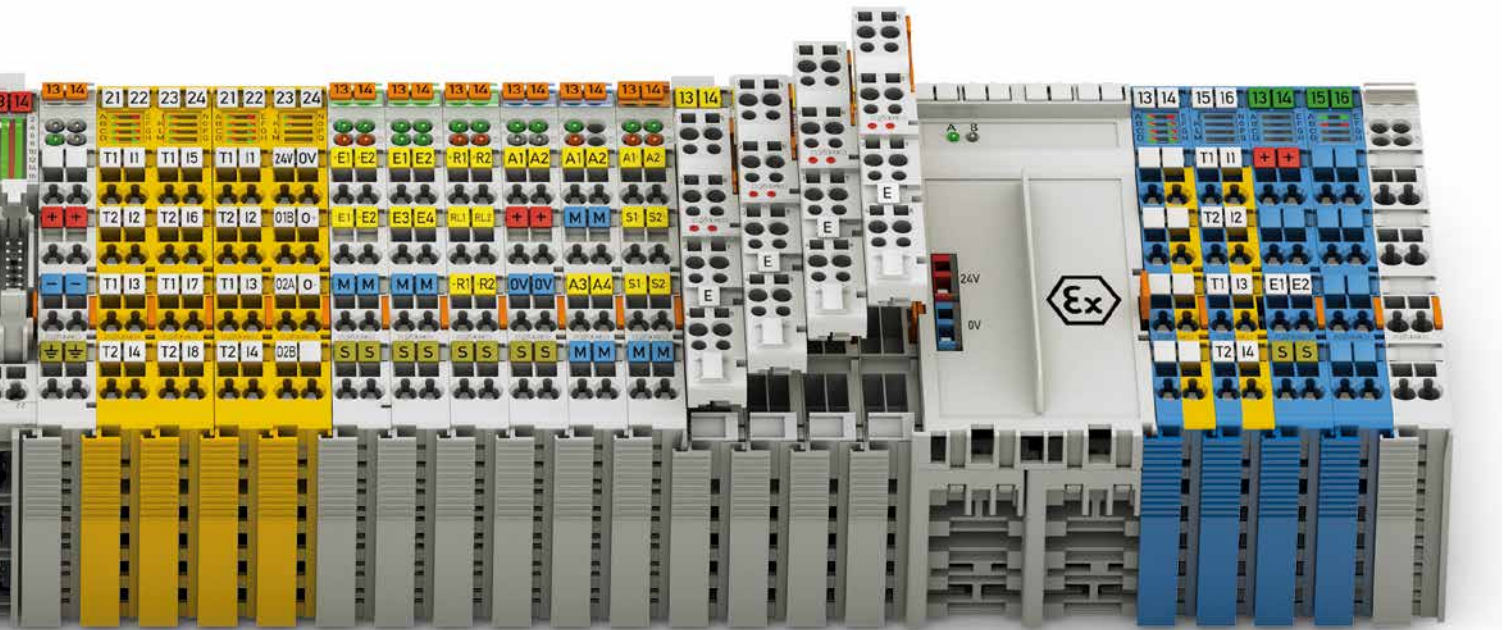

### Pluggable Connection Interface

For the ultimate convenience, 753 Series Modules are 100 % compatible with the 750 Series and feature pluggable connectors. A detachable wiring interface allows an operator to easily replace a module without removing and then rewiring all pre-existing wiring. This convenience virtually eliminates installation errors. This allows flexible pre-wiring – with placeholder modules if necessary – and saves time.

### Maximum Flexibility

Each node in the WAGO I/O System can be configured to meet every channel's requirements; various potentials and signal types are available (granularity of 1–16 channels). Digital and analog inputs and outputs, as well as specialty modules, can be freely combined. Supply modules permit different voltages within the same node.

### Maximum Reliability and Ruggedness

The WAGO I/O System is engineered and tested for use in the most demanding environments in accordance with the highest standards, e.g., those required in shipbuilding applications. The system differs from other products that are solely intended for industrial use through its:

- Greatly increased vibration rating
- Significantly greater immunity to interference (ESD)
- Lower emission of interference
- Larger voltage fluctuation range
- Greater durability for continuous operation in upper temperature ranges

In addition, CAGE CLAMP® spring pressure connections ensure superior reliability.

Integrated QA measures in the production process and 100 % function testing ensure consistent quality.

### Ease of use

A modular DIN-rail-mount design permits easy installation, expansion and modification of the bus module without tools. The straight-forward design prevents installation errors. In addition, proven CAGE CLAMP® technology offers fast, vibration-proof, maintenance-free connections on the field side. Depending on the bus module's granularity, field peripherals can be directly wired using 1-, 2-, 3- or 4-wire technology.

- Fieldbus-independent – support for the most common fieldbus protocols and ETHERNET standards
- Flexible platform adapts to diverse applications and environments
- Tested and approved worldwide
- Extensive range of accessories for marking systems and connection technology
- CAGE CLAMP® technology for vibration-proof, fast and maintenance-free connections

# WAGO I/O System – 750 / 753 / 763 / 768 Series

## Marking and Mounting Accessories

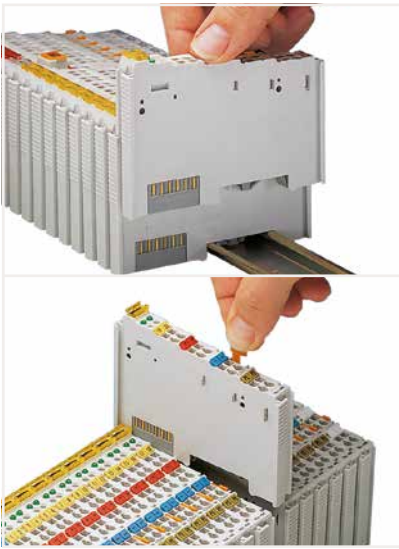

Securing/releasing a module on the mounting rail

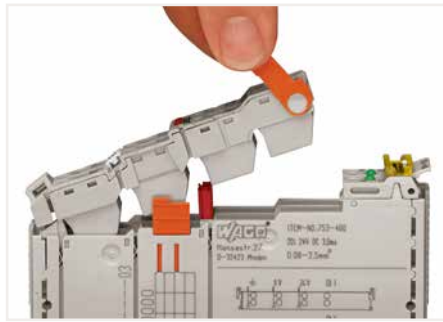

Removing the pluggable connector

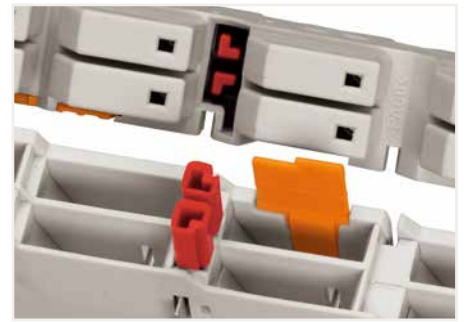

Optional protection against mismatching of pluggable connector via coding elements

6

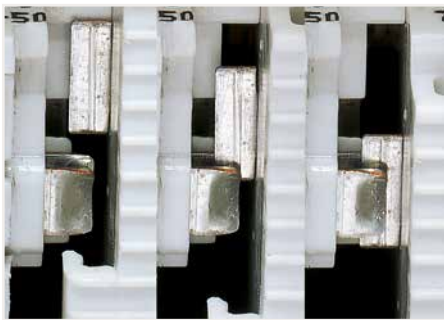

Secure, automatic power supply connection via self-cleaning blade contacts



Secure, automatic data and electronics power supply connection via gold-plated pressure contacts



Securing a cable to the connector



Transparent group marker carriers indicate module type by color.

Color	Function
Yellow	Digital input
Red	Digital output
Green	Analog input
Blue	Analog output
Transparent	Specialty function

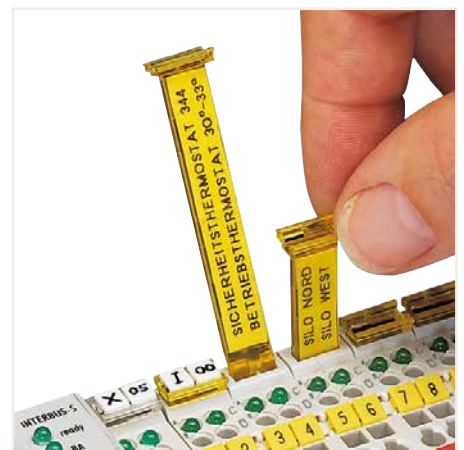

Removable group marker carriers are available for all 750 and 753 Series I/O Modules with a maximum of four LEDs, as well as all fieldbus couplers with a supply module.



# WAGO I/O System – 750 / 753 / 763 / 768 Series

## Application and Installation Instructions



Marker carrier for one I/O node; both models (750-106 and 750-107) permit continuous marking regardless of the I/O module housing used.



Marker carrier for a single I/O module (suitable for all 750 and 753 Series I/O Modules); the marker carrier can be inserted into the upper Mini-WSB marker slot.

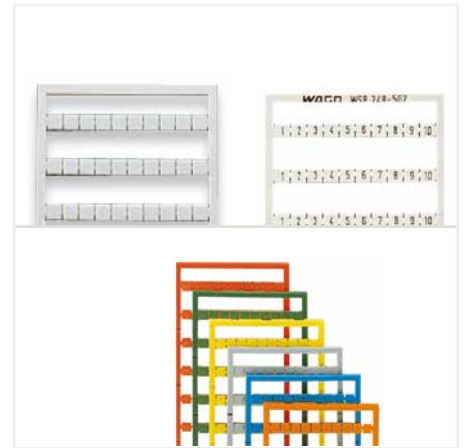

Mini-WSB Marking Card, blank, pre-marked and colored; suitable for all 750 and 753 Series I/O Modules.



Service interface for configuring the fieldbus coupler; connectivity via configuration cable or radio adapter

**Note:**

For some I/O modules, not all power jumper contacts are connected! Therefore, a module with three power jumper contacts (e.g., 2-channel digital input) cannot be snapped into place behind a module if every contact is not connected.

To increase electromagnetic compatibility (EMC), some components are connected to the DIN-rail through a discharge contact. The DIN-rail must always have a low-resistance connection to the ground potential.



Wide range of accessories available for EMC-compliant installation, including shield connection

6



Interface Modules for System Wiring



WAGO System Cable

## WAGO I/O System Advanced Interfaces and Types

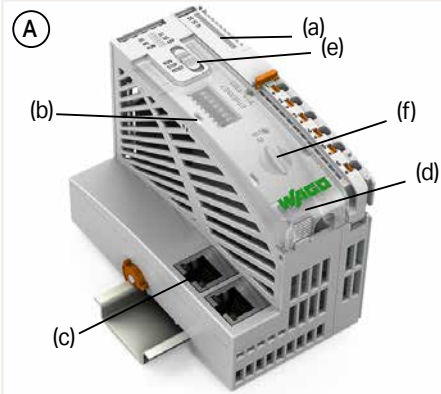

- Includes supply module to power downstream I/O modules (a)
- Connection technology (system/field supply): Push-in CAGE CLAMP®; conductor cross-section, mechanical: solid/fine-stranded: 0.25 ... 2.5 mm<sup>2</sup> / 22 ... 14 AWG
- Address switch (b)
- 2 RJ45 fieldbus interfaces (c)
- Service interface (d)
- W x H x D (mm): 63 x 105 x 75

### Housing Design: PFC200 Controller (A)

- Start/stop switch (e)
- MicroSD card slot for external storage media (f)

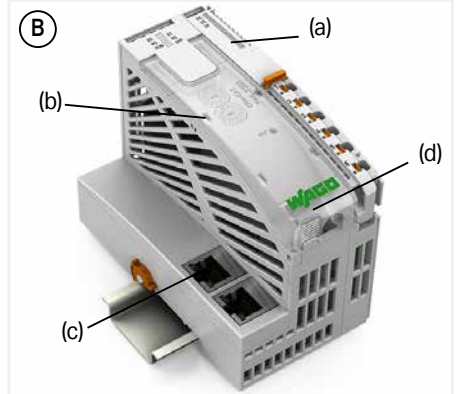

### Housing Design: Fieldbus Coupler (B)

### Housing Design: I/O Module (C, D)

- Function differentiation by color coding: (a) yellow = digital input; red = digital output; gray = supply
- I/O modules consist of an electronic unit (b), a base unit (c) and a pluggable wiring unit (d).
- 16 connection points (Push-in CAGE CLAMP®); conductor cross-section, mechanical: solid/fine-stranded: 0.25 ... 1.5 mm<sup>2</sup> / 22 ... 16 AWG
- W x H x D (mm): 12 x 105 x 75

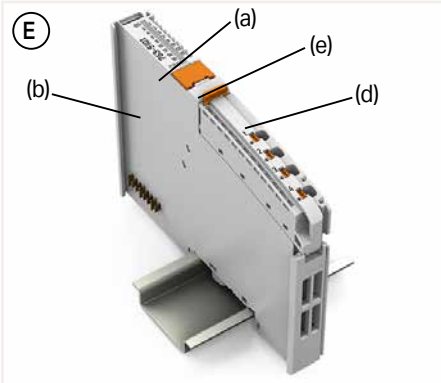
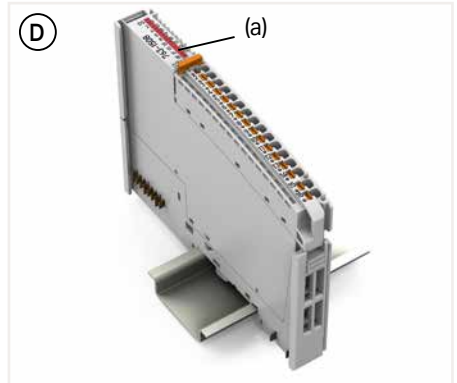
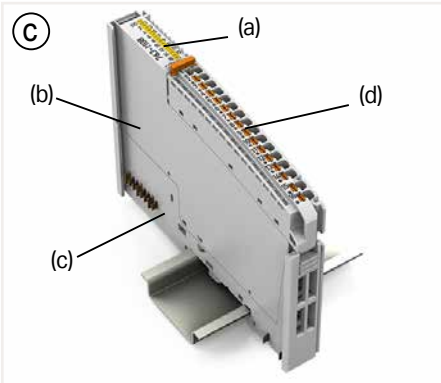

- Supply modules consist of an electronic unit with integrated base unit (a) and pluggable wiring unit (c).
- Conductor cross-section, mechanical: solid/fine-stranded: 0.25 ... 2.5 mm<sup>2</sup> / 22 ... 14 AWG
- W x H x D (mm): 12 x 105 x 75

### Housing Design: Power Supply with Fuse Holder (E)

- Fuse holder (e) for fuse (size: 5 x 20 mm)
- 4 connection points (Push-in CAGE CLAMP®) for field supply



### Housing Design: System Power Supply (F)

- 6 connection points (Push-in CAGE CLAMP®) for system/field supply

### Housing Design: End Module (G)

- The end module completes the internal data bus and protects the contacts.
- W x H x D (mm): 8.5 x 105 x 75

### Housing Design: 750 Series Gateway (H)

- The 750 Series gateway connects the 750/753 Series modules to an I/O node of the WAGO I/O System Advanced.
- W x H x D (mm): 12 x 105 x 65

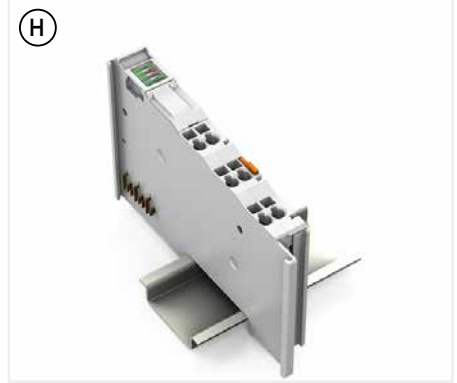



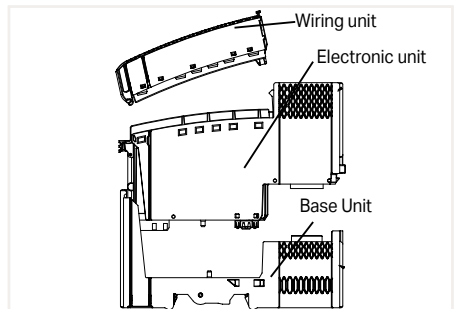







A module consists of a base, an electronic module and a pluggable connector. Optionally, the wiring unit and the base unit can be ordered separately.







6

## WAGO I/O System Advanced – 763/768 Series

### Product Overview

Figure	Description	Communication	ETHERNET protocols	CPU	Visualization	Item No.	
<b>Controllers</b>							
	PFC200 Controller; 2 x ETHERNET	Modbus (TCP, UDP)	DHCP; DNS; NTP; FTP; FTPS; SNMP; HTTP; HTTPS; SSH	Cortex A8; 1 GHz	Web Visu	768-3301	
Figure	Description	Fieldbus	Protocols	Transfer Rate	Item No.		
<b>Fieldbus couplers</b>							
	Fieldbus Coupler; EtherCAT®	EtherCat®	EtherCAT® (direct mode)	100 Mbit/s	768-2201		
Figure	Description	Function	Number of Channels				Item No.
			Input		Output		
			8	16	8	16	
<b>Digital Input Modules</b>							
	2-Channel Digital Input; 24 VDC; fast	High-side switching		X			763-1108
	16-Channel Digital Input; 24 VDC	High-side switching			X		763-1116
<b>Digital Output Modules</b>							
	8-Channel Digital Output; 24 VDC; 0.5 A	Semiconductor; push-pull; short-circuit-protected; self-resetting			X		763-1508
	16-Channel Digital Output; 24 VDC; 0.5 A	Semiconductor; high-side switching; short-circuit-protected; self-resetting				X	763-1516
Figure	Description	Total Current (Field Supply)	Data Width	Item No.			
<b>Supply Modules</b>							
	Supply Module 24 VDC; fuse holder	Max. 6.3 ADC	2 bits; bit 0: power supply status (field) in front of the fuse; bit 1: power supply status (field) behind the fuse (at the power jumper contacts)	763-5101			
Figure	Description	Total Current (System Supply)	Data Width	Item No.			
<b>System Power Supply</b>							
	System Power Supply; 24 VDC	Max. 3.9 A	1 bit; bit 0: field power supply status	763-5120			
Figure	Description	Total Current (System Supply)	Isolation, Field/System	Item No.			
<b>Gateway</b>							
	Gateway	0.7 A at 5 V	500 VDC (1 min) min.; per EN/UL 61010-2-201	763-4750/010-000			
<b>End Module</b>							
	End Module			763-5600			
<b>Accessories</b>							
	Wiring Unit; 16-pole			763-351			
	Wiring Unit; 6-pole			763-353			
	Wiring Unit; 4-pole			763-354			
	Base Module			763-301			
	Micro-WSB Inline; 2000 per reel; plain; snap-on type; white			2009-141			

# WAGO I/O System – 750 Series Controllers

Figure	ETHERNET Ports											Description	Item No.								
	ETHERNET (RJ45)	ETHERNET (M12)	ETHERNET (FX)	CODESYS V2.3	eCOCKPIT	Modbus (TCP, UDP)	EtherNet/IP™	EtherCAT®	PROFINET	PROFIBUS	CANopen		RS-232/485	Modbus® RTU	Telecontrol Protocols	IoT Protocols	BACnet/IP	Standard	Ext. Temperature	XTR	
<b>PFC100 Controller; CPU: Cortex A8; 600 MHz</b>																					
	2				x	M/S	S									x	Eco	750-8100			
	2				x	M/S	S									x		750-8101	750-8101/025-000		
	2				x	M/S	S					x	x		x			750-8102	750-8102/025-000		
	2				x	M/S	S										FG0	750-8101/000-010			
<b>PFC200 Controller; 2nd Generation; CPU Cortex A8; 1 GHz</b>																					
	4			x	x	M/S	S	M*						x*	x			750-8210	750-8210/025-000		
	2			x	x	M/S	S	M*				x	x		x	x*		750-8212	750-8212/025-000		
	2			x	x	M/S	S	M*				x	x	x	x				750-8212/025-001		
	2			x	x	M/S	S	M*					x	x	x				750-8212/025-002		
	2			x		M/S	S	M*					x		x	x		750-8212/000-100			
	2			x	x	M/S	S	M*			M/S				x	x*	CAN	750-8213			
	2			x	x	M/S	S	M*			M/S	x	x		x		CAN	750-8214			
	4				x	M/S	S	M*	S		M/S				x		CAN, USB	750-8215	750-8215/025-000		
	2			x	x	M/S	S	M*		S	M/S	x	x		x		CAN	750-8216	750-8216/025-000		
	2			x	x	M/S	S	M*		S	M/S	x	x	x	x		CAN		750-8216/025-001		
2			x	x	M/S	S	M*					x	x*	x			750-8217	750-8217/025-000			
<b>PFC200 Controller; 2nd Generation; CPU Cortex A8; 1 GHz; Extreme</b>																					
	4			x	x															750-8210/040-000	
	2		2	x	x	M/S	S	M*							x			750-8211	750-8211/040-000		
				x	x															750-8216/040-000	
	2			x	x	M/S	S	M*					x		x					750-8212/040-010	
2			x	x	M/S	S	M*			M/S				x						750-8213/040-010	
<b>PFC200 Controller; CPU: Cortex A8; 600 MHz</b>																					
	2			x	x	M/S	S					x	x		x		Mobile radio module	750-8207	750-8207/025-000		
	2			x	x	M/S	S					x	x	x	x		Mobile radio module		750-8207/025-001		
	2			x		M/S	S			M		x	x		x		CAN	750-8208	750-8208/025-000		
	2			x		M/S	S			M		x	x	x	x		CAN		750-8208/025-001		
	2			x	x	M/S	S					x	x		x		FG1	750-8202/000-011			
	2			x	x	M/S	S					x	x		x		FG2	750-8202/000-012			
	2			x	x	M/S	S					x	x		x		Application for Energy Data Management	750-8202/000-022			
	2			x	x	M/S	S					x	x		x		Energy Data Management Application; Mobile Radio Module	750-8207/000-022			
<b>PFC200 Controller; XTR; CPU: Cortex A8; 600 MHz</b>																					
	2			x	x	M/S	S					x	x		x					750-8202/040-000	
	2			x	x	M/S	S					x	x	x	x					750-8202/040-001	
	2			x	x	M/S	S			S	M/S	x	x		x		CAN			750-8206/040-000	
	2			x	x	M/S	S			S	M/S	x	x	x	x		CAN			750-8206/040-001	







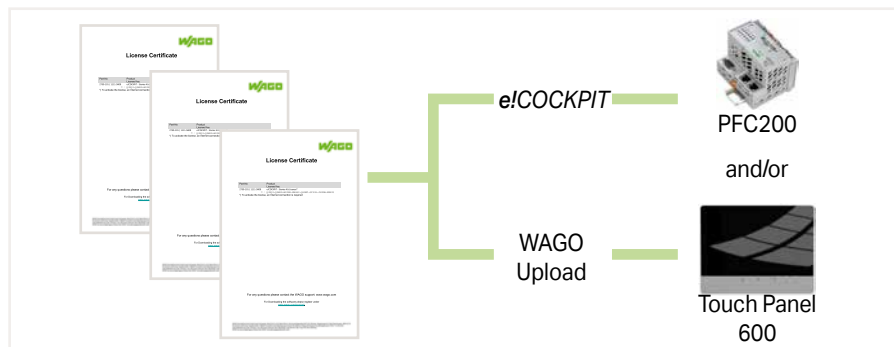

M: Master, S: Slave; \* requires an additional license

PFC200 Starter Kit		
Figure	Contents	Item No.
	PFC100 Controller (750-8100); supply module (750-602); digital input module (750-400); digital output module (750-501); end module (750-600); power supply (750-1602); DI simulator (288-863); eCOCKPIT starter kit license; USB communication cable (750-923); 2 GB memory card (758-879/000-3102); operating tool (210-719; 210-720); patch cable	8003-099/750-8100

- Additional licensed functions**
- EtherCAT® Master
  - BACnet
  - Telecontrol
  - Lighting Management
  - Energy Data Management
  - Controller Redundancy
  - Home Automation
  - Power Grid Management



# WAGO I/O System – 750 Series Controllers

Figure	ETHERNET (RJ45)	CPU (bit)	ETHERNET								Description	Item No.					
			CODESYS V2.3	Modbus (TCP, UDP)	EtherNet/IP™	BACnet/IP	KNX IP	Modbus® RTU	Telecontrol Protocols	BACnet MS/TP		SD Memory Card Slot	Standard	Ext. Temperature	XTR		
<b>ETHERNET controller</b>																	
	2	32	x	M/S	S							x	3. generation; media redundancy	750-885	750-885/025-000		
	2		x	M/S	S									3. generation; media redundancy	750-882		
	1	16	x	M/S									1. generation; without Visu	750-842			
	1		x	M/S										1. generation; without Visu; Eco	750-843		
<b>EtherNet/IP™ Controller</b>																	
	2	32	x		S								4. generation	750-893			
	2		x		S								x	4. generation; Eco	750-823		
<b>Modbus® Controller</b>																	
	2		x	M/S									4. generation	750-890	750-890/025-000	750-890/040-000	
	2		x	M/S					x		x		4. generation		750-890/025-001		
	2	32	x	M/S					x		x		4. generation; connect up to 4 modules; Eco		750-890/025-002		
	2		x	M/S									4. generation	750-891			
			x	M/S									4. generation; Eco	750-862			
		16	x							x				RS-485; 115.2 kBd; without Visu	750-815/300-000	750-815/325-000	
		x							x				RS-232; 115.2 kBd; without Visu	750-816/300-000			
<b>KNX/IP Controller</b>																	
	2	32	x	M/S								x	KNX/IP Controller	750-889			
<b>BACnet Controller</b>																	
	2	32	x	M/S		x							4. generation	750-832			
	2		x		x								x	4. generation; Eco	750-832/000-002		
	2	x	M/S								x			750-829			
<b>DeviceNet Slave Controller</b>																	
		16	x										Without Visu	750-806			
<b>PROFIBUS Slave Controller</b>																	
		16	x										Without Visu	750-833	750-833/025-000		
<b>CANopen Master/Slave Controller</b>																	
		16	x										128/64 KB of memory; MCS; without Visu	750-837			
			x										640/832 KB of memory; MCS; without Visu	750-837/021-000			
			x											128/64 KB of memory; D-sub; without Visu	750-838		
			x											640/832 KB of memory; D-sub; without Visu	750-838/021-000		750-838/040-000
<b>Modbus® Controller; XTR; Telecontrol Protocols</b>																	
	2		x								x	x	RS-232/-485			750-890/040-001	

M: Master, S: Slave; \* requires an additional license

# WAGO I/O System Fieldbus couplers

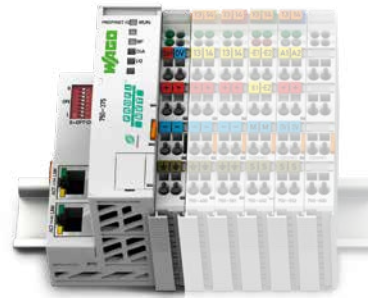

Housing Design I with Field Supply	
Dimensions (W x H x D)	50.5 x 71.1 x 100 mm
Height from upper-edge of DIN-rail	63.9 mm
Connection technology for system supply and field supply	CAGE CLAMP®
Conductor cross-section	0.08 ... 2.5 mm <sup>2</sup> / 28 ... 14 AWG
Strip length	8 ... 9 mm / 0.33 inch

Housing Design II with Field Supply	
Dimensions (W x H x D)	61.5 x 71.9 x 100 mm
Height from upper-edge of DIN-rail	64.7 mm
Connection technology for system supply and field supply	CAGE CLAMP®
Conductor cross-section	0.08 ... 2.5 mm <sup>2</sup> / 28 ... 14 AWG
Strip length	8 ... 9 mm / 0.33 inch

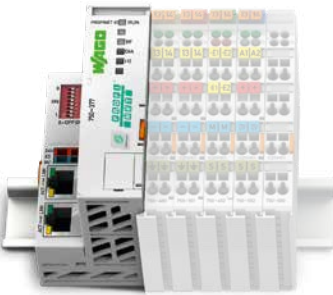

Housing Design without Field Supply	
Dimensions (W x H x D)	49.5 x 71.9 x 96.8 mm
Height from upper-edge of DIN-rail	64.7 mm
Supply system connection technology	CAGE CLAMP®
Conductor cross-section	0.08 ... 1.5 mm <sup>2</sup> / 28 ... 16 AWG
Strip length	5 ... 6 mm / 0.22 inch

Eco Housing Design (without Field Supply)	
Dimensions (W x H x D)	49.5 x 71.9 x 96.8 mm
Height from upper-edge of DIN-rail	64.7 mm
Supply system connection technology	CAGE CLAMP®
Conductor cross-section	0.08 ... 1.5 mm <sup>2</sup> / 28 ... 16 AWG
Strip length	5 ... 6 mm / 0.22 inch









General Technical Specifications			
System supply voltage	24 VDC (-25 % ... +30 %)*; * For all marine-certified fieldbus couplers and I/O modules	Housing material	Polycarbonate; polyamide 6.6
Isolation	500 V (system/supply)	Exposure to pollutants	Per IEC 60068-2-42 and IEC 60068-2-43
Surrounding air temperature (operation)	0 ... +55 °C	Permissible SO <sub>2</sub> contaminant concentration at a relative humidity < 75 %	25 ppm
Surrounding air temperature (operation) for versions with an extended temperature range	-20 ... +60 °C	Permissible H <sub>2</sub> S contaminant concentration at a relative humidity < 75 %	10 ppm
Surrounding air temperature (storage)	-40 ... +85 °C	Connection technology	CAGE CLAMP®
Relative humidity	95 % (non-condensing)	Conductor range; strip length with standard modules and couplers:	0.08 ... 2.5 mm <sup>2</sup> /28 ... 14 AWG; 8 ... 9 mm/0.31 ... 0.35 inch
Relative humidity for versions with an extended temperature range	Max. 95 %; short-term condensation per class 3K6 / IEC EN 60721-3-3 and E DIN 40046-721-3, taking a temperature range of -20 to +60 °C into consideration (except wind-driven precipitation, water and ice formation)	I/O modules, 753 Series:	0.08 ... 2.5 mm <sup>2</sup> /28 ... 14 AWG; 9 ... 10 mm/0.35 ... 0.39 inch
Operating altitude	0 ... 2000 m / 0 ... 6562 ft	ECO fieldbus couplers:	0.08 ... 1.5 mm <sup>2</sup> /28 ... 16 AWG; 5 ... 6 mm/0.2 ... 0.24 inch
Pollution degree	2 per IEC 61131-2	Connection technology	Push-in CAGE CLAMP®
Vibration resistance	0.5g (4g for all marine-certified fieldbus couplers and I/O modules) per IEC 60068-2-6	Conductor cross-section; strip length for I/O modules with 16 connection points:	Solid: 0.08 ... 1.5 mm <sup>2</sup> /28 ... 16 AWG; Fine-stranded: 0.25 ... 1.5 mm <sup>2</sup> /22 ... 16 AWG; 8 ... 9 mm / 0.31 ... 0.35 inch
Shock resistance	15g per IEC 60068-2-27	Current carrying capacity of power jumper contacts	10 A
EMC immunity to interference	Per EN 61000-6-2		
EMC emission of interference	Per EN 61000-6-3; EN 61000-6-4		
Protection class	IP20		
Mounting type	DIN-35 rail mounting		

## Approvals



## WAGO I/O System – 750 Series

### Fieldbus couplers

Fieldbus System	Housing Design				Description	Item No.
	I with Field Supply	II with Field Supply	Without Field Supply	Eco		
<b>PROFINET</b>						
	<input type="checkbox"/>	<input type="checkbox"/>	<input type="checkbox"/>	<input type="checkbox"/>	PROFINET IO; 3rd generation; Advanced	750-375
	<input type="checkbox"/>	<input type="checkbox"/>	<input type="checkbox"/>	<input type="checkbox"/>	PROFINET IO; 3rd generation; extended temperature; Advanced	750-375/025-000
	<input type="checkbox"/>	<input type="checkbox"/>	<input type="checkbox"/>	<input type="checkbox"/>	PROFINET IO; 3rd generation; Eco Advanced	750-377
	<input type="checkbox"/>	<input type="checkbox"/>	<input type="checkbox"/>	<input type="checkbox"/>	PROFINET IO; 3rd generation; extended temperature	750-377/025-000
<b>PROFIBUS</b>						
	<input type="checkbox"/>	<input type="checkbox"/>	<input type="checkbox"/>	<input type="checkbox"/>	PROFIBUS DP; 2nd generation; 12 MBd	750-333*
	<input type="checkbox"/>	<input type="checkbox"/>	<input type="checkbox"/>	<input type="checkbox"/>	PROFIBUS DP; 2nd generation; 12 MBd; extended temperature	750-333/025-000
	<input type="checkbox"/>	<input type="checkbox"/>	<input type="checkbox"/>	<input type="checkbox"/>	PROFIBUS DP; 12 MBd; Eco	750-343
<b>ETHERNET/IP</b>						
	<input type="checkbox"/>	<input type="checkbox"/>	<input type="checkbox"/>	<input type="checkbox"/>	Ethernet/IP™; 4th generation; Eco	750-363
	<input type="checkbox"/>	<input type="checkbox"/>	<input type="checkbox"/>	<input type="checkbox"/>	Ethernet/IP™; 4th generation; Eco; XTR	750-363/040-000
	<input type="checkbox"/>	<input type="checkbox"/>	<input type="checkbox"/>	<input type="checkbox"/>	Ethernet/IP™; 4th generation; supports DLR	750-366
<b>Modbus/TCP</b>						
<i>MODBUS/TCP</i>	<input type="checkbox"/>	<input type="checkbox"/>	<input type="checkbox"/>	<input type="checkbox"/>	Modbus TCP; 4th generation	750-362
	<input type="checkbox"/>	<input type="checkbox"/>	<input type="checkbox"/>	<input type="checkbox"/>	ETHERNET; 1st generation	750-342
<b>BACnet</b>						
	<input type="checkbox"/>	<input type="checkbox"/>	<input type="checkbox"/>	<input type="checkbox"/>	BACnet/IP; 4th generation; SD card slot	750-332
<b>EtherCAT</b>						
	<input type="checkbox"/>	<input type="checkbox"/>	<input type="checkbox"/>	<input type="checkbox"/>	EtherCAT®	750-354
	<input type="checkbox"/>	<input type="checkbox"/>	<input type="checkbox"/>	<input type="checkbox"/>	EtherCAT; ID switch	750-354/000-001
	<input type="checkbox"/>	<input type="checkbox"/>	<input type="checkbox"/>	<input type="checkbox"/>	EtherCAT; ID switch; diagnostics	750-354/000-002
<b>DeviceNet</b>						
	<input type="checkbox"/>	<input type="checkbox"/>	<input type="checkbox"/>	<input type="checkbox"/>	DeviceNet	750-306
	<input type="checkbox"/>	<input type="checkbox"/>	<input type="checkbox"/>	<input type="checkbox"/>	DeviceNet; Eco	750-346
<b>CANopen</b>						
	<input type="checkbox"/>	<input type="checkbox"/>	<input type="checkbox"/>	<input type="checkbox"/>	CANopen	750-307
	<input type="checkbox"/>	<input type="checkbox"/>	<input type="checkbox"/>	<input type="checkbox"/>	CANopen; MCS	750-337
	<input type="checkbox"/>	<input type="checkbox"/>	<input type="checkbox"/>	<input type="checkbox"/>	CANopen; MCS; extended temperature	750-337/025-000
	<input type="checkbox"/>	<input type="checkbox"/>	<input type="checkbox"/>	<input type="checkbox"/>	CANopen; D-sub	750-338*
	<input type="checkbox"/>	<input type="checkbox"/>	<input type="checkbox"/>	<input type="checkbox"/>	CANopen; MCS; Eco	750-347
	<input type="checkbox"/>	<input type="checkbox"/>	<input type="checkbox"/>	<input type="checkbox"/>	CANopen; D-sub; Eco	750-348
<b>Modbus</b>						
<i>MODBUS</i>	<input type="checkbox"/>	<input type="checkbox"/>	<input type="checkbox"/>	<input type="checkbox"/>	Modbus®; RS-485; 115.2 kBd	750-315/300-000
	<input type="checkbox"/>	<input type="checkbox"/>	<input type="checkbox"/>	<input type="checkbox"/>	Modbus®; RS-232; 115.2 kBd	750-316/300-000
<b>INTERBUS</b>						
	<input type="checkbox"/>	<input type="checkbox"/>	<input type="checkbox"/>	<input type="checkbox"/>	INTERBUS	750-304
	<input type="checkbox"/>	<input type="checkbox"/>	<input type="checkbox"/>	<input type="checkbox"/>	INTERBUS; 500 kbit/s; Eco	750-344
<b>CC-Link</b>						
	<input type="checkbox"/>	<input type="checkbox"/>	<input type="checkbox"/>	<input type="checkbox"/>	CC-Link	750-310
	<input type="checkbox"/>	<input type="checkbox"/>	<input type="checkbox"/>	<input type="checkbox"/>	CC-Link; 156 kBd ... 10 MBd	750-325

# Digital Input Modules



## 750 Series Housing Design

Dimensions (W x H x D)	Housing with 4 LEDs: 12 x 69.8 x 100 mm Housing with 8 LEDs: 12 x 67.8 x 100 mm
Height from upper-edge of DIN-rail	Housing with 4 LEDs: 62.6 mm Housing with 8 LEDs: 60.6 mm
Connection technology	CAGE CLAMP®
Conductor cross-section	0.08 ... 2.5 mm <sup>2</sup> / 28 ... 14 AWG
Strip length	8 ... 9 mm / 0.33 inch

## 753 Series Housing Design

Dimensions (W x H x D)	Housing with 4 LEDs: 12 x 69.8 x 100 mm Housing with 8 LEDs: 12 x 69 x 100 mm
Height from upper-edge of DIN-rail	Housing with 4 LEDs: 62.6 mm Housing with 8 LEDs: 61.8 mm
Connection technology	CAGE CLAMP®
Conductor cross-section	0.08 ... 2.5 mm <sup>2</sup> / 28 ... 14 AWG
Strip length	9 ... 10 mm / 0.37 inch

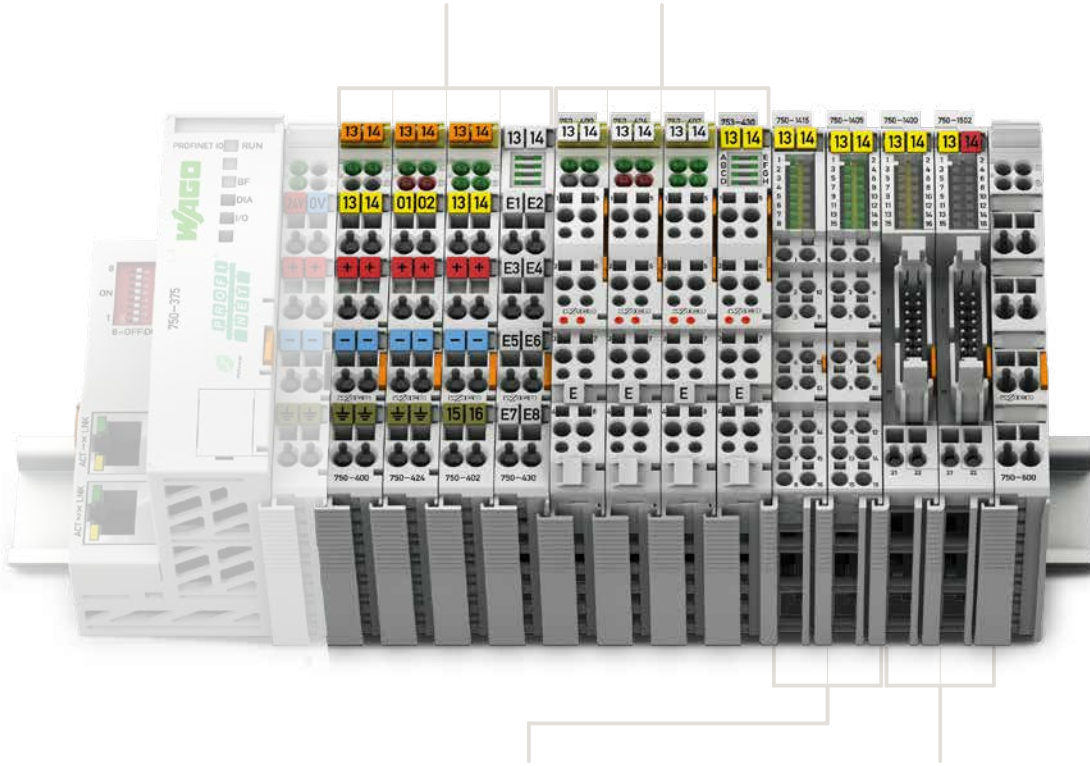

6

### 750 Series housing design, with Push-in CAGE CLAMP® connections (up to 16 connection points)

Dimensions (W x H x D)	12 x 69 x 100 mm
Height from upper-edge of DIN-rail	61.8 mm
Connection technology	Push-in CAGE CLAMP®
Conductor cross-section	Solid: 0.08 ... 1.5 mm <sup>2</sup> / 28 ... 16 AWG Fine-stranded: 0.25 ... 1.5 mm <sup>2</sup> / 22 ... 16 AWG
Strip length	8 ... 9 mm / 0.33 inch

### 750 Series housing design, with ribbon cable connection

Dimensions (W x H x D)	12 x 74.1 x 100 mm
Height from upper-edge of DIN-rail	66.9 mm
Connection technology	20-pole male header + 2 x CAGE CLAMP®
Conductor cross-section	0.08 ... 2.5 mm <sup>2</sup> / 28 ... 14 AWG
Strip length	8 ... 9 mm / 0.33 inch

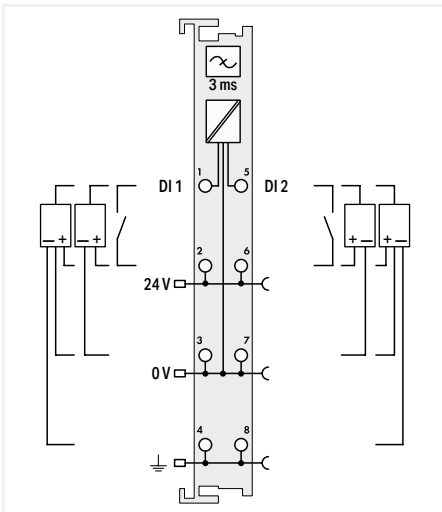

2 Channels; 750-400

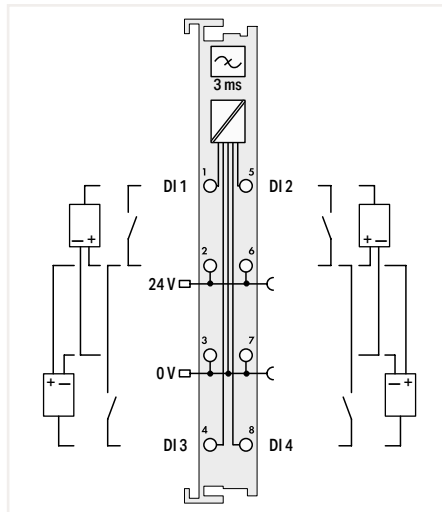

4 Channels; 750-402

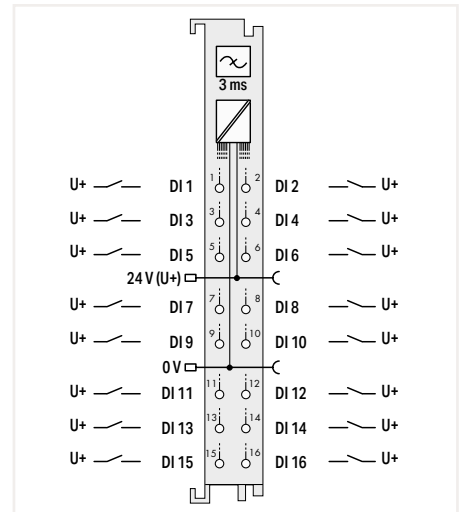

16 Channels; 750-1405



# WAGO I/O System – 750/753 Series

## Digital Input Modules

Function	2-Channel DI	4-Channel DI	8-Channel DI	16-Channel DI	8-Channel DIO	Description	Item Number			
							Standard	Ext. Temperature	Pluggable	
5 VDC		<input type="checkbox"/>				4-Channel Digital Input; 5 VDC; 0.2 ms	750-414			
5/12 VDC			<input type="checkbox"/>			8-Channel Digital Input; 5/12 VDC; 0.2 ms			753-434	
24 VDC	<input type="checkbox"/>					2-Channel Digital Input; 24 VDC; 3 ms	750-400	750-400/025-000	753-400	
	<input type="checkbox"/>					2-Channel Digital Input; 24 VDC; 3 ms; acknowledgment; diagnostics	750-418		753-418	
	<input type="checkbox"/>					2-Channel Digital Input; 24 VDC; 3 ms; diagnostics	750-421		753-421	
		<input type="checkbox"/>				4-Channel Digital Input; 24 VDC; 3 ms	750-402	750-402/025-000	753-402	
		<input type="checkbox"/>				4-Channel Digital Input; 24 VDC; 3 ms; 2-wire connection	750-432		753-432	
		<input type="checkbox"/>				4-Channel Digital Input; 24 VDC; 3 ms; 3-wire connection	750-1420			
			<input type="checkbox"/>			8-Channel Digital Input; 24 VDC; 3 ms	750-430	750-430/025-000	753-430	
			<input type="checkbox"/>			8-Channel Digital Input; 24 VDC; 3 ms; 2-wire connection	750-1415			
				<input type="checkbox"/>		16-Channel Digital Input; 24 VDC; 3 ms; ribbon cable	750-1400			
				<input type="checkbox"/>		16-Channel Digital Input; 24 VDC; 3 ms	750-1405			
					<input type="checkbox"/>	8-Channel Digital Input/Output; 24 VDC; 0.5 A; ribbon cable	750-1502			
					<input type="checkbox"/>	8-Channel Digital Input/Output; 24 VDC; 0.5 A	750-1506			
	3 ms; High-Side Switching	<input type="checkbox"/>					2-Channel Digital Input; 24 VDC; 0.2 ms	750-401		753-401
			<input type="checkbox"/>				4-Channel Digital Input; 24 VDC; 0.2 ms	750-403		753-403
		<input type="checkbox"/>				4-Channel Digital Input; 24 VDC; 0.2 ms; 2-wire connection	750-433		753-433	
		<input type="checkbox"/>				4-Channel Digital Input; 24 VDC; 0.2 ms; 3-wire connection	750-1421			
			<input type="checkbox"/>			8-Channel Digital Input; 24 VDC; 0.2 ms	750-431		753-431	
			<input type="checkbox"/>			8-Channel Digital Input; 24 VDC; 0.2 ms; 2-wire connection	750-1416			
0.2 ms; High-Side Switching				<input type="checkbox"/>		16-Channel Digital Input; 24 VDC; 0.2 ms	750-1406			
		<input type="checkbox"/>				4-Channel Digital Input; 24 VDC; 3 ms	750-408	750-408/025-000	753-408	
		<input type="checkbox"/>				4-Channel Digital Input; 24 VDC; 3 ms; 3-wire connection	750-1422			
			<input type="checkbox"/>			8-Channel Digital Input; 24 VDC; 3 ms	750-436		753-436	
3 ms; Low-Side Switching			<input type="checkbox"/>			8-Channel Digital Input; 24 VDC; 3 ms; 2-wire connection	750-1417			
				<input type="checkbox"/>		16-Channel Digital Input; 24 VDC; 3 ms; ribbon cable	750-1402			
				<input type="checkbox"/>		16-Channel Digital Input; 24 VDC; 3 ms	750-1407			
0.2 ms; Low-Side Switching		<input type="checkbox"/>				4-Channel Digital Input; 24 VDC; 0.2 ms	750-409		753-409	
		<input type="checkbox"/>				4-Channel Digital Input; 24 VDC; 0.2 ms; 3-wire connection	750-1423			
			<input type="checkbox"/>			8-Channel Digital Input; 24 VDC; 0.2 ms	750-437		753-437	
			<input type="checkbox"/>			8-Channel Digital Input; 24 VDC; 0.2 ms; 2-wire connection	750-1418			
24 VAC/DC	<input type="checkbox"/>					2-Channel Digital Input; 24 VDC; 3 ms; proximity sensor	750-410		753-410	
	<input type="checkbox"/>					2-Channel Digital Input; 24 VDC; 0.2 ms; proximity sensor	750-411		753-411	
	<input type="checkbox"/>					2-Channel Digital Input; NAMUR	750-425		753-425	
	<input type="checkbox"/>					2-Channel Digital Input; intruder detection	750-424		753-424	
		<input type="checkbox"/>				4-Channel Digital Input; 24 VDC; pulse extension	750-422		753-422	
		<input type="checkbox"/>				4-Channel Digital Input; 24 VAC/DC; 20 ms	750-415		753-415	
		<input type="checkbox"/>				4-Channel Digital Input; 24 VAC/DC; 50 ms	750-423		753-423	
42 VAC/DC		<input type="checkbox"/>				4-Channel Digital Input; 24 VAC/DC; 20 ms	750-428		753-428	
48 VDC	<input type="checkbox"/>					2-Channel Digital Input; 48 VDC; 3 ms	750-412		753-412	
60 VDC	<input type="checkbox"/>					2-Channel Digital Input; 60 VDC; 3 ms			753-429	
110 VDC	<input type="checkbox"/>					2-Channel Digital Input; 110 VDC; high-side/low-side switching	750-427		753-427	
220 VDC	<input type="checkbox"/>					2-Channel Digital Input; 220 VDC	750-407			
120 VAC	<input type="checkbox"/>					2-Channel Digital Input; 120 VAC	750-406		753-406	
120/230 VAC		<input type="checkbox"/>				4-Channel Digital Input; 120/230 VAC			753-440	
230 VAC	<input type="checkbox"/>					2-Channel Digital Input; 230 VAC	750-405		753-405	
PTC			<input type="checkbox"/>			8-Channel Digital Input; PTC	750-1425			

# Digital Output Modules



## 750 Series Housing Design

Dimensions (W x H x D)	Housing with 4 LEDs: 12 x 69.8 x 100 mm Housing with 8 LEDs: 12 x 67.8 x 100 mm
Height from upper-edge of DIN-rail	Housing with 4 LEDs: 62.6 mm Housing with 8 LEDs: 60.6 mm
Connection technology	CAGE CLAMP®
Conductor cross-section	0.08 ... 2.5 mm <sup>2</sup> / 28 ... 14 AWG
Strip length	8 ... 9 mm / 0.33 inch

## 753 Series Housing Design

Dimensions (W x H x D)	Housing with 4 LEDs: 12 x 69.8 x 100 mm Housing with 8 LEDs: 12 x 69 x 100 mm
Height from upper-edge of DIN-rail	Housing with 4 LEDs: 62.6 mm Housing with 8 LEDs: 61.8 mm
Connection technology	CAGE CLAMP®
Conductor cross-section	0.08 ... 2.5 mm <sup>2</sup> / 28 ... 14 AWG
Strip length	9 ... 10 mm / 0.37 inch

## 750 Series Specialty Housing

Dimensions (W x H x D)	24 x 67.8 x 100 mm
Height from upper-edge of DIN-rail	60.6 mm

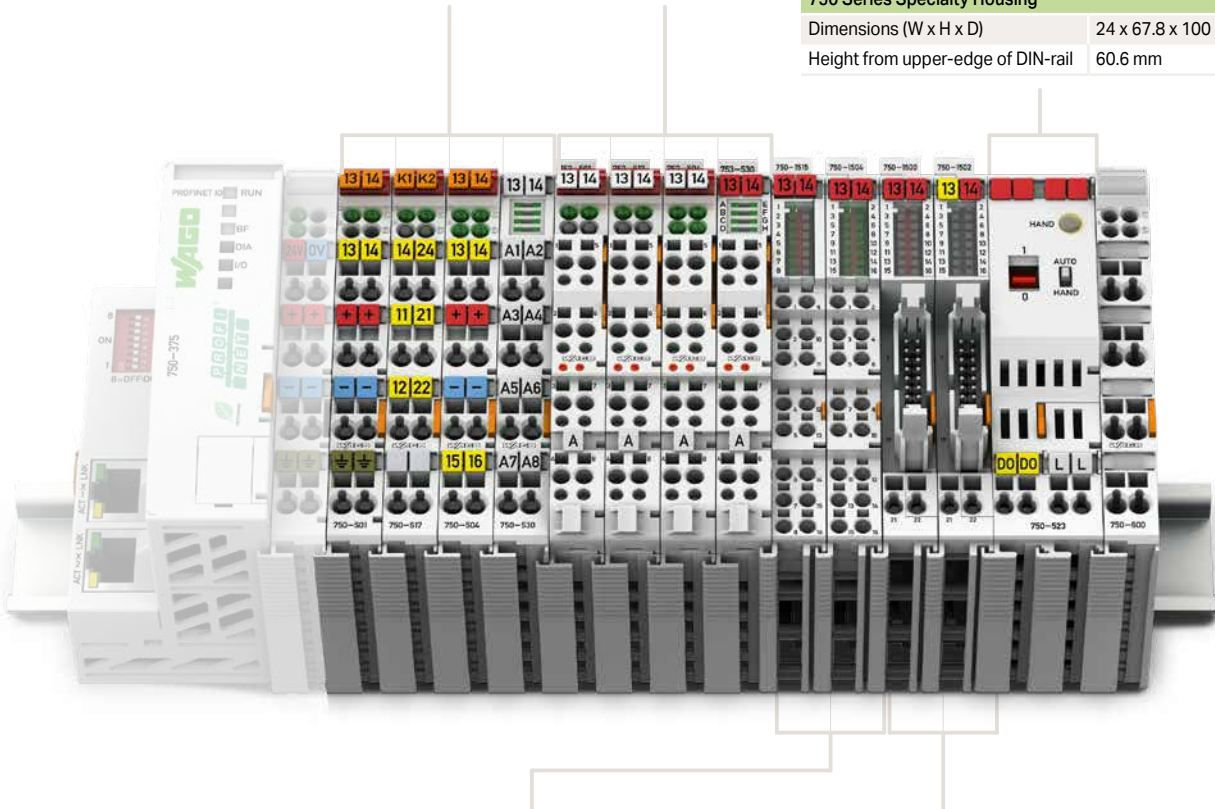

## 750 Series housing design, with Push-in CAGE CLAMP® connections (up to 16 connection points)

Dimensions (W x H x D)	12 x 69 x 100 mm
Height from upper-edge of DIN-rail	61.8 mm
Connection technology	Push-in CAGE CLAMP®
Conductor cross-section	Solid: 0.08 ... 1.5 mm <sup>2</sup> / 28 ... 16 AWG Fine-stranded: 0.25 ... 1.5 mm <sup>2</sup> / 22 ... 16 AWG
Strip length	8 ... 9 mm / 0.33 inch

## 750 Series housing design, with ribbon cable connection

Dimensions (W x H x D)	12 x 74.1 x 100 mm
Height from upper-edge of DIN-rail	66.9 mm
Connection technology	20-pole male header + 2 x CAGE CLAMP®
Conductor cross-section	0.08 ... 2.5 mm <sup>2</sup> / 28 ... 14 AWG
Strip length	8 ... 9 mm / 0.33 inch

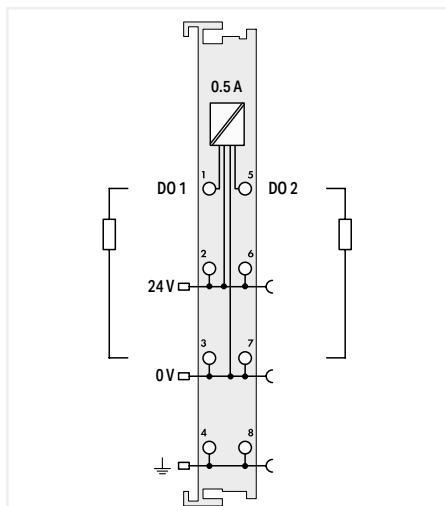

2 Channels; 750-501

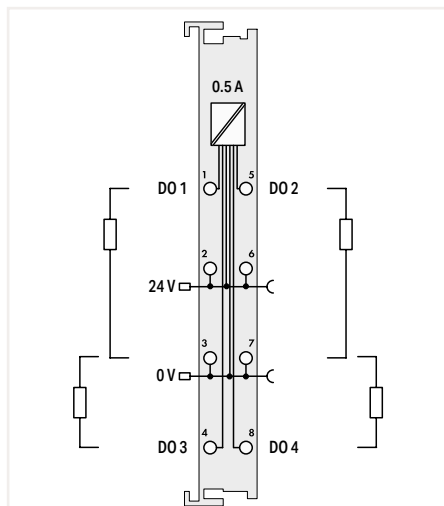

4 Channels; 750-504

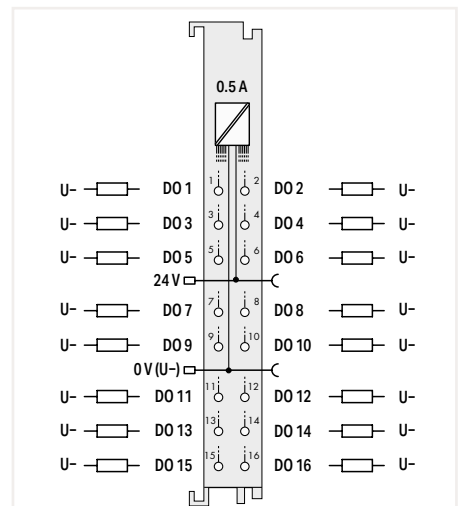

16 Channels; 750-1504

6

# WAGO I/O System – 750/753 Series

## Digital Output Modules

Function	1-Channel DO	2-Channel DO	4-Channel DO	8-Channel DO	16-Channel DO	8-Channel DIO	Description	Item Number		
								Standard	Ext. Temperature	Pluggable
5 VDC			■				4-Channel Digital Output; 5 VDC; 20 mA	750-519		
5/12 VDC				■			8-Channel Digital Output; 12 VDC; 1 A	750-534		753-534
24 VDC		■					2-Channel Digital Output; 24 VDC; 0.5 A	750-501		753-501
		■					2-Channel Digital Output; 24 VDC; 0.5 A; interference-free	750-501/000-800		753-501/000-800
		■					2-Channel Digital Output; 24 VDC; 2.0 A	750-502		753-502
		■					2-Channel Digital Output; 24 VDC; 2.0 A; interference-free	750-502/000-800		753-502/000-800
		■					2-Channel Digital Output; 24 VDC; 0.5 A; diagnostics	750-506		753-506
		■					2-Channel Digital Output; 24 VDC; 0.5 A; interference-free; diagnostics	750-506/000-800		
		■					2-Channel Digital Output; 24 VDC; 2.0 A; diagnostics	750-508		753-508
		■					2-Channel Digital Output; 24 VDC; 2.0 A; interference-free; diagnostics	750-508/000-800		
				■			4-Channel Digital Output; 24 VDC; 0.5 A	750-504	750-504/025-000	753-504
				■			4-Channel Digital Output; 24 VDC; 0.5 A; interference-free	750-504/000-800	750-504/025-800	
				■			4-Channel Digital Output; 24 VDC; 0.5 A; 2-wire connection	750-531		753-531
				■			4-Channel Digital Output; 24 VDC; 0.5 A; 2-wire connection; interference-free	750-531/000-800		753-531/000-800
				■			4-Channel Digital Output; 24 VDC; 0.5 A; low-side switching	750-516		753-516
				■			4-Channel Digital Output; 24 VDC; 0.5 A; diagnostics	750-532		
					■		8-Channel Digital Output; 24 VDC; 0.5 A	750-530	750-530/025-000	753-530
					■		8-Channel Digital Output; 24 VDC; 0.5 A; low-side switching	750-536		753-536
					■		8-Channel Digital Output; 24 VDC; 0.5 A; diagnostics	750-537		753-537
					■		8-Channel Digital Output; 24 VDC; 0.5 A; 2-wire connection	750-1515		
						■	8-Channel Digital Output; 24 VDC; 0.5 A; low-side switching; 2-wire connection	750-1516		
							■ 8-Channel Digital Input/Output; 24 VDC; 0.5 A; ribbon cable	750-1502		
						■ 8-Channel Digital Input/Output; 24 VDC; 0.5 A	750-1506			
					■	16-Channel Digital Output; 24 VDC; 0.5 A; ribbon cable	750-1500			
					■	16-Channel Digital Output; 24 VDC; 0.5 A	750-1504			
					■	16-Channel Digital Output; 24 VDC; 0.5 A; low-side switching; ribbon cable	750-1501			
					■	16-Channel Digital Output; 24 VDC; 0.5 A; low-side switching	750-1505			
30 VAC/DC			■				4-Channel Digital Output; 30 VAC/DC; 2.5 A; solid-state	750-527		
			■				4-Channel Digital Output; 30 VAC/DC; 2.5 A; solid-state; isolated	750-528		
120/230 VAC			■				4-Channel Digital Output; 230 VAC; 0.25 A; solid-state			753-540
230 VAC/VDC		■					2-Channel Digital Output; 230 VAC; 0.3 A; solid-state	750-509		753-509
Relays		■					2-Channel Relay Output; 125 VAC; 0.5 A; potential-free; 2 changeover contacts	750-514		753-514
		■					2-Channel Relay Output; 250 VAC; 0.5 A; potential-free; 2 changeover contacts	750-517		753-517
		■					2-Channel Relay Output; 250 VAC; 2.0 A; 2 make contacts	750-512		753-512
		■					2-Channel Relay Output; 250 VAC; 2.0 A; potential-free; 2 make contact	750-513		753-513
		■					2-Channel Relay Output; 250 VAC; 2.0 A; potential-free; 2 make contacts; without power jumper contacts	750-513/000-001		753-513/000-001
				■			4-Channel Relay Output; 250 VAC; 2.0 A; potential-free; 4 make contact	750-515		
	■					1-Channel Relay Output; 250 VAC; 16 A; potential-free; 1 make contact	750-523			

# Analog Input Modules



## 750 Series Housing Design

Dimensions (W x H x D)	Housing with 4 LEDs: 12 x 69.8 x 100 mm Housing with 8 LEDs: 12 x 67.8 x 100 mm
Height from upper-edge of DIN-rail	Housing with 4 LEDs: 62.6 mm Housing with 8 LEDs: 60.6 mm
Connection technology	CAGE CLAMP®
Conductor cross-section	0.08 ... 2.5 mm <sup>2</sup> / 28 ... 14 AWG
Strip length	8 ... 9 mm / 0.33 inch

## 753 Series Housing Design

Dimensions (W x H x D)	Housing with 4 LEDs: 12 x 69.8 x 100 mm Housing with 8 LEDs: 12 x 69 x 100 mm
Height from upper-edge of DIN-rail	Housing with 4 LEDs: 62.6 mm Housing with 8 LEDs: 61.8 mm
Connection technology	CAGE CLAMP®
Conductor cross-section	0.08 ... 2.5 mm <sup>2</sup> / 28 ... 14 AWG
Strip length	9 ... 10 mm / 0.37 inch

## 750 Series Housing Design, Double Width

Dimensions (W x H x D)	24 x 67.8 x 100 mm
Height from upper-edge of DIN-rail	60.6 mm

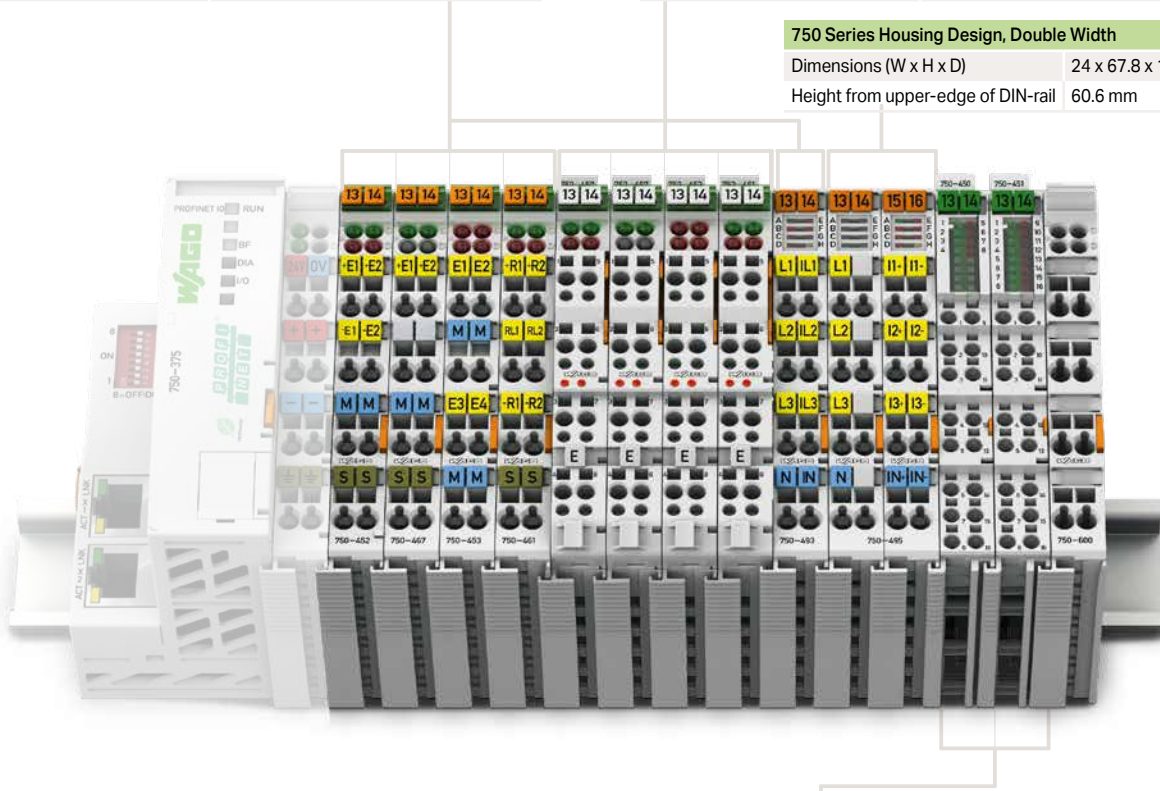

## 750 Series housing design, with Push-in CAGE CLAMP® connections (up to 16 connection points)

Dimensions (W x H x D)	12 x 69 x 100 mm
Height from upper-edge of DIN-rail	61.8 mm
Connection technology	Push-in CAGE CLAMP®
Conductor cross-section	Solid: 0.08 ... 1.5 mm <sup>2</sup> / 28 ... 16 AWG Fine-stranded: 0.25 ... 1.5 mm <sup>2</sup> / 22 ... 16 AWG
Strip length	8 ... 9 mm / 0.33 inch

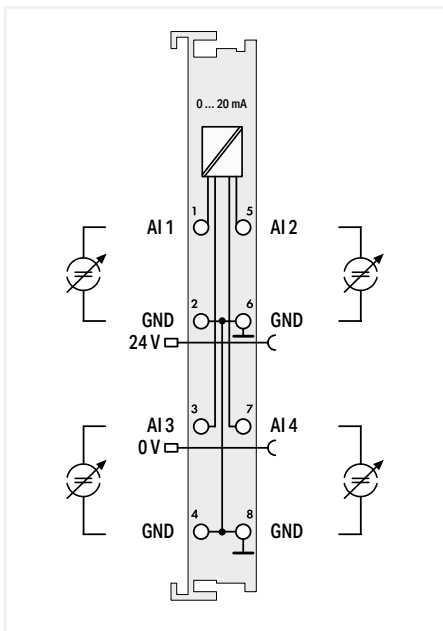

4 Channels; 750-453

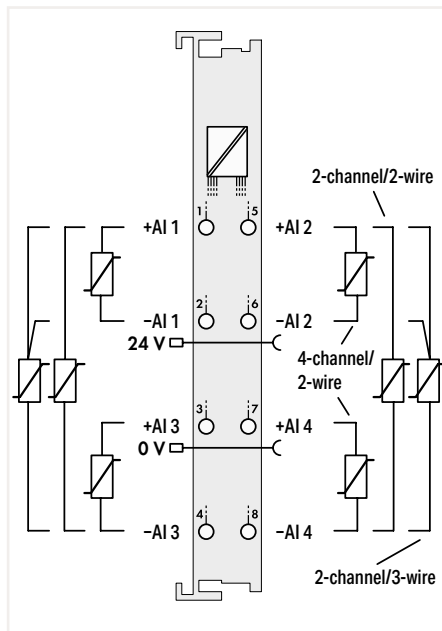

2/4 Channels; 750-464

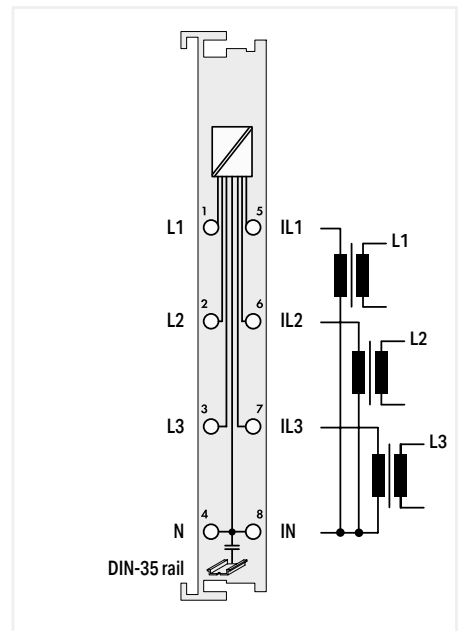

2 Channels; 750-494

6

# WAGO I/O System – 750/753 Series

## Analog Input Modules

Function	1-Channel AI	2-Channel AI	4-Channel AI	8-Channel AI	Description	Item Number			
						Standard	/S5 or /S7 Customized Data Format	Ext. Temperature	Pluggable
0 ... 20 mA	<input type="checkbox"/>	<input type="checkbox"/>	<input type="checkbox"/>	<input type="checkbox"/>	2-Channel Analog Input; 0 ... 20 mA; differential input	750-452	750-452/000-200		753-452
	<input type="checkbox"/>	<input type="checkbox"/>	<input type="checkbox"/>	<input type="checkbox"/>	2-Channel Analog Input; 0 ... 20 mA; differential input	750-480			753-480
	<input type="checkbox"/>	<input type="checkbox"/>	<input type="checkbox"/>	<input type="checkbox"/>	2-Channel Analog Input; 0 ... 20 mA; single-ended	750-465		750-465/025-000	753-465
	<input type="checkbox"/>	<input type="checkbox"/>	<input type="checkbox"/>	<input type="checkbox"/>	2-Channel Analog Input; 0 ... 20 mA; single-ended	750-470			
	<input type="checkbox"/>	<input type="checkbox"/>	<input type="checkbox"/>	<input type="checkbox"/>	2-Channel Analog Input; 0 ... 20 mA; single-ended; 60 Hz	750-470/005-000			
	<input type="checkbox"/>	<input type="checkbox"/>	<input type="checkbox"/>	<input type="checkbox"/>	2-Channel Analog Input; 0 ... 20 mA; single-ended; 16 bits	750-472			753-472
	<input type="checkbox"/>	<input type="checkbox"/>	<input type="checkbox"/>	<input type="checkbox"/>	2-Channel Analog Input; 0 ... 20 mA; single-ended; 16 bits; 60 Hz	750-472/005-000			
4 ... 20 mA	<input type="checkbox"/>	<input type="checkbox"/>	<input type="checkbox"/>	<input type="checkbox"/>	4-Channel Analog Input; 0 ... 20 mA; single-ended	750-453			753-453
	<input type="checkbox"/>	<input type="checkbox"/>	<input type="checkbox"/>	<input type="checkbox"/>	2-Channel Analog Input; 4 ... 20 mA; differential input	750-454	750-454/000-200	750-454/025-000	753-454
	<input type="checkbox"/>	<input type="checkbox"/>	<input type="checkbox"/>	<input type="checkbox"/>	2-channel analog input, 4-20 mA, differential input, extended measurement range	750-454/000-003		750-454/025-003	
	<input type="checkbox"/>	<input type="checkbox"/>	<input type="checkbox"/>	<input type="checkbox"/>	2-Channel Analog Input; 4 ... 20 mA; differential input	750-492			753-492
	<input type="checkbox"/>	<input type="checkbox"/>	<input type="checkbox"/>	<input type="checkbox"/>	2-Channel Analog Input; 4 ... 20 mA; single-ended	750-466	750-466/000-200	750-466/025-000	753-466
	<input type="checkbox"/>	<input type="checkbox"/>	<input type="checkbox"/>	<input type="checkbox"/>	2-Channel Analog Input; 4 ... 20 mA; single-ended	750-473			
	<input type="checkbox"/>	<input type="checkbox"/>	<input type="checkbox"/>	<input type="checkbox"/>	2-Channel Analog Input; 4 ... 20 mA; single-ended; 60 Hz	750-473/005-000			
	<input type="checkbox"/>	<input type="checkbox"/>	<input type="checkbox"/>	<input type="checkbox"/>	2-Channel Analog Input; 4 ... 20 mA; single-ended; 16 bits	750-474	750-474/000-200		753-474
	<input type="checkbox"/>	<input type="checkbox"/>	<input type="checkbox"/>	<input type="checkbox"/>	2-Channel Analog Input; 4 ... 20 mA; single-ended; 16 bits; 60 Hz	750-474/005-000			
0/4 ... 20 mA	<input type="checkbox"/>	<input type="checkbox"/>	<input type="checkbox"/>	<input type="checkbox"/>	2-Channel Analog Input; 4 ... 20 mA HART	750-482	750-482/000-300	750-482/025-000	753-482
	<input type="checkbox"/>	<input type="checkbox"/>	<input type="checkbox"/>	<input type="checkbox"/>	2-Channel Analog Input; 4 ... 20 mA HART; NAMUR NE43	750-482/000-001			
	<input type="checkbox"/>	<input type="checkbox"/>	<input type="checkbox"/>	<input type="checkbox"/>	4-Channel Analog Input; 4 ... 20 mA; single-ended	750-455		750-455/025-000	753-455
	<input type="checkbox"/>	<input type="checkbox"/>	<input type="checkbox"/>	<input type="checkbox"/>	4-Channel Analog Input; 4 ... 20 mA; single-ended; 4 x 24 V	750-455/020-000			
0/4 ... 20 mA	<input type="checkbox"/>	<input type="checkbox"/>	<input type="checkbox"/>	8-Channel Analog Input; 0/4 ... 20 mA; single-ended	750-496				
0 ... 1 A	<input type="checkbox"/>	<input type="checkbox"/>	<input type="checkbox"/>	<input type="checkbox"/>	2-Channel Analog Input; 0 ... 1 VAC/DC; differential input	750-475			753-475
0 ... 5 A	<input type="checkbox"/>	<input type="checkbox"/>	<input type="checkbox"/>	<input type="checkbox"/>	2-Channel Analog Input; 0 ... 5 VAC/DC; differential input	750-475/020-000			
±10 V	<input type="checkbox"/>	<input type="checkbox"/>	<input type="checkbox"/>	<input type="checkbox"/>	2-Channel Analog Input; ±10 VDC; differential input	750-456	750-456/000-200		753-456
	<input type="checkbox"/>	<input type="checkbox"/>	<input type="checkbox"/>	<input type="checkbox"/>	2-Channel Analog Input; ±10 VDC; differential input	750-479			753-479
	<input type="checkbox"/>	<input type="checkbox"/>	<input type="checkbox"/>	<input type="checkbox"/>	2-Channel Analog Input; ±10 VDC; single-ended; 16 bits	750-476	750-476/000-200		753-476
	<input type="checkbox"/>	<input type="checkbox"/>	<input type="checkbox"/>	<input type="checkbox"/>	4-Channel Analog Input; ±10 VDC; single-ended	750-457		750-457/025-000	753-457
0 ... 10 V	<input type="checkbox"/>	<input type="checkbox"/>	<input type="checkbox"/>	<input type="checkbox"/>	2-Channel Analog Input; 0 ... 10 VDC; single-ended	750-467			753-467
	<input type="checkbox"/>	<input type="checkbox"/>	<input type="checkbox"/>	<input type="checkbox"/>	2-Channel Analog Input; 0 ... 10 VDC; single-ended; 16 bits	750-478			753-478
	<input type="checkbox"/>	<input type="checkbox"/>	<input type="checkbox"/>	<input type="checkbox"/>	2-Channel Analog Input; 0 ... 10 VDC; single-ended; 16 bits; 60 Hz	750-478/005-000			
	<input type="checkbox"/>	<input type="checkbox"/>	<input type="checkbox"/>	<input type="checkbox"/>	4-Channel Analog Input; 0 ... 10 VDC; single-ended	750-468		750-468/025-000	
0 ... 10 V/±10 V	<input type="checkbox"/>	<input type="checkbox"/>	<input type="checkbox"/>	<input type="checkbox"/>	4-Channel Analog Input; 0 ... 10 VDC; single-ended	750-459			753-459
	<input type="checkbox"/>	<input type="checkbox"/>	<input type="checkbox"/>	<input type="checkbox"/>	8-Channel Analog Input; 0 ... 10 VDC/±10 V; single-ended	750-497			
0 ... 10 VAC/DC	<input type="checkbox"/>	<input type="checkbox"/>	<input type="checkbox"/>	<input type="checkbox"/>	2-Channel Analog Input; 0 ... 10 VAC/DC; differential input	750-477			753-477
0 ... 30 V	<input type="checkbox"/>	<input type="checkbox"/>	<input type="checkbox"/>	<input type="checkbox"/>	2-channel analog input; 0 ... 30 VDC; differential input	750-483			753-483
Voltage/Current	<input type="checkbox"/>	<input type="checkbox"/>	<input type="checkbox"/>	<input type="checkbox"/>	4-Channel Analog Input; for voltage/current	750-471			
Resistance Sensors	<input type="checkbox"/>	<input type="checkbox"/>	<input type="checkbox"/>	<input type="checkbox"/>	2-Channel Analog Input; for Pt100/RTD resistance sensors	750-461	750-461/000-200	750-461/025-000	753-461
	<input type="checkbox"/>	<input type="checkbox"/>	<input type="checkbox"/>	<input type="checkbox"/>	2-Channel Analog Input; for Pt100/RTD resistance sensors; adjustable	750-461/003-000			753-461/003-000
	<input type="checkbox"/>	<input type="checkbox"/>	<input type="checkbox"/>	<input type="checkbox"/>	2-Channel Analog Input; for NTC 20k resistance sensors	750-461/020-000			
	<input type="checkbox"/>	<input type="checkbox"/>	<input type="checkbox"/>	<input type="checkbox"/>	2/4-Channel Analog Input; resistance measurement; adjustable	750-464			
	<input type="checkbox"/>	<input type="checkbox"/>	<input type="checkbox"/>	<input type="checkbox"/>	4-Channel Analog Input; for NTC resistance sensors; adjustable	750-464/020-000			
	<input type="checkbox"/>	<input type="checkbox"/>	<input type="checkbox"/>	<input type="checkbox"/>	4-Channel Analog Input; resistance measurement; measurement range: -30 ... +150 °C	750-463			
	<input type="checkbox"/>	<input type="checkbox"/>	<input type="checkbox"/>	<input type="checkbox"/>	4-Channel Analog Input; resistance measurement; adjustable	750-450			
Thermocouples	<input type="checkbox"/>	<input type="checkbox"/>	<input type="checkbox"/>	<input type="checkbox"/>	8-Channel Analog Input; resistance measurement; adjustable	750-451		750-451/025-000	
	<input type="checkbox"/>	<input type="checkbox"/>	<input type="checkbox"/>	<input type="checkbox"/>	2-Channel Analog Input; thermocouple K; diagnostics	750-469	750-469/000-200		753-469
	<input type="checkbox"/>	<input type="checkbox"/>	<input type="checkbox"/>	<input type="checkbox"/>	2-Channel Analog Input; thermocouple K; diagnostics; adjustable	750-469/003-000			753-469/003-000
	<input type="checkbox"/>	<input type="checkbox"/>	<input type="checkbox"/>	<input type="checkbox"/>	2-Channel Analog Input; thermocouple J; diagnostics	750-469/000-006			
Analog Specialty Functions	<input type="checkbox"/>	<input type="checkbox"/>	<input type="checkbox"/>	<input type="checkbox"/>	8-Channel Analog Input; thermocouple; adjustable	750-498			
	<input type="checkbox"/>	<input type="checkbox"/>	<input type="checkbox"/>	<input type="checkbox"/>	1-Channel Analog Input; resistor bridges (strain gauges)	750-491			
	<input type="checkbox"/>	<input type="checkbox"/>	<input type="checkbox"/>	<input type="checkbox"/>	1-Channel Analog Input; resistor bridges (strain gauges); 125 ms conversion time	750-491/000-001			
	<input type="checkbox"/>	<input type="checkbox"/>	<input type="checkbox"/>	<input type="checkbox"/>	2-Channel Analog Input; resistor bridges (strain gauges)	750-1491			
	<input type="checkbox"/>	<input type="checkbox"/>	<input type="checkbox"/>	<input type="checkbox"/>	3-Phase Power Measurement Module; 480 VAC; 1 A	750-493		750-493/025-000	
	<input type="checkbox"/>	<input type="checkbox"/>	<input type="checkbox"/>	<input type="checkbox"/>	3-Phase Power Measurement Module; 480 VAC; 5 A	750-493/000-001			
	<input type="checkbox"/>	<input type="checkbox"/>	<input type="checkbox"/>	<input type="checkbox"/>	3-Phase Power Measurement Module; 480 VAC; 1 A	750-494		750-494/025-000	
	<input type="checkbox"/>	<input type="checkbox"/>	<input type="checkbox"/>	<input type="checkbox"/>	3-Phase Power Measurement Module; 480 VAC; 5 A	750-494/000-001		750-494/025-001	
	<input type="checkbox"/>	<input type="checkbox"/>	<input type="checkbox"/>	<input type="checkbox"/>	Power Measurement; 277 VAC/DC; external shunts	750-494/000-005			
	<input type="checkbox"/>	<input type="checkbox"/>	<input type="checkbox"/>	<input type="checkbox"/>	3-Phase Power Measurement Module; 690 VAC; 1 A	750-495			
	<input type="checkbox"/>	<input type="checkbox"/>	<input type="checkbox"/>	<input type="checkbox"/>	3-Phase Power Measurement Module; 690 VAC; 5 A	750-495/000-001			
<input type="checkbox"/>	<input type="checkbox"/>	<input type="checkbox"/>	<input type="checkbox"/>	3-Phase Power Measurement; 690 VAC; Rogowski coils	750-495/000-002				

# Analog Output Modules



750 Series Housing Design	
Dimensions (W x H x D)	12 x 69.8 x 100 mm
Height from upper-edge of DIN-rail	62.6 mm
Connection technology	CAGE CLAMP®
Conductor cross-section	0.08 ... 2.5 mm <sup>2</sup> / 28 ... 14 AWG
Strip length	8 ... 9 mm / 0.33 inch

753 Series Housing Design	
Dimensions (W x H x D)	12 x 69.8 x 100 mm
Height from upper-edge of DIN-rail	62.6 mm
Connection technology	CAGE CLAMP®
Conductor cross-section	0.08 ... 2.5 mm <sup>2</sup> / 28 ... 14 AWG
Strip length	9 ... 10 mm / 0.37 inch

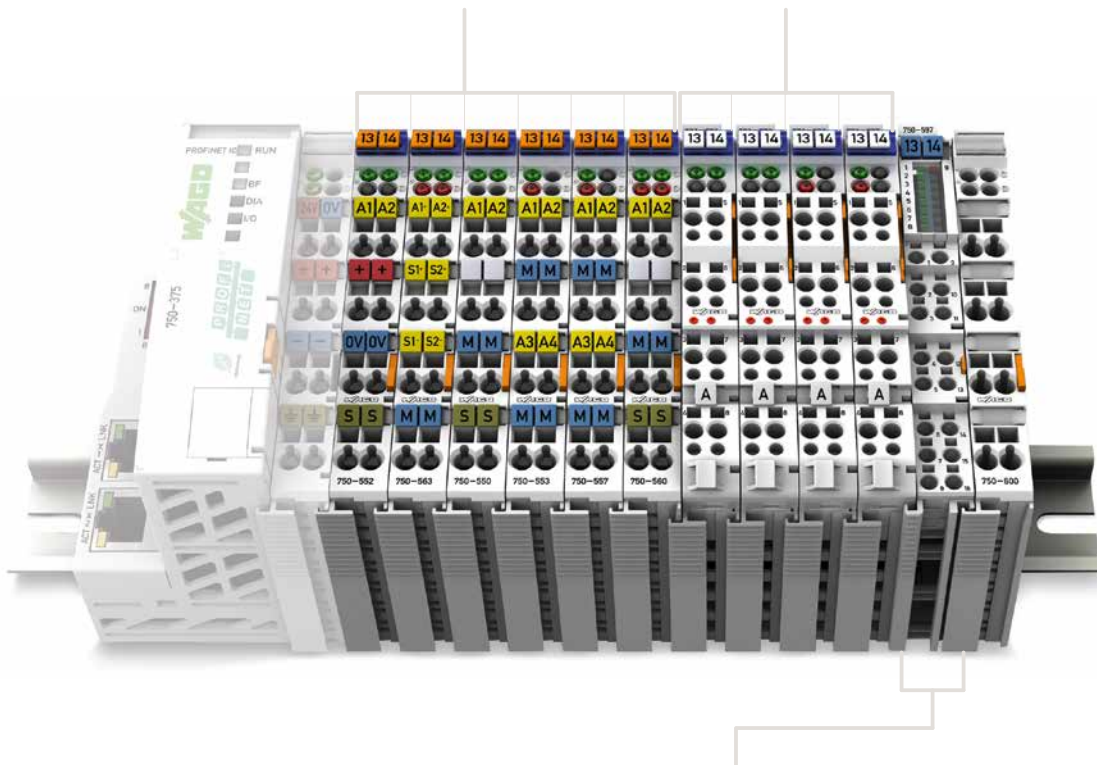

6

**750 Series housing design, with Push-in CAGE CLAMP® connections (up to 16 connection points)**

Dimensions (W x H x D)	12 x 69 x 100 mm
Height from upper-edge of DIN-rail	61.8 mm
Connection technology	Push-in CAGE CLAMP®
Conductor cross-section	Solid: 0.08 ... 1.5 mm <sup>2</sup> / 28 ... 16 AWG Fine-stranded: 0.25 ... 1.5 mm <sup>2</sup> / 22 ... 16 AWG
Strip length	8 ... 9 mm / 0.33 inch

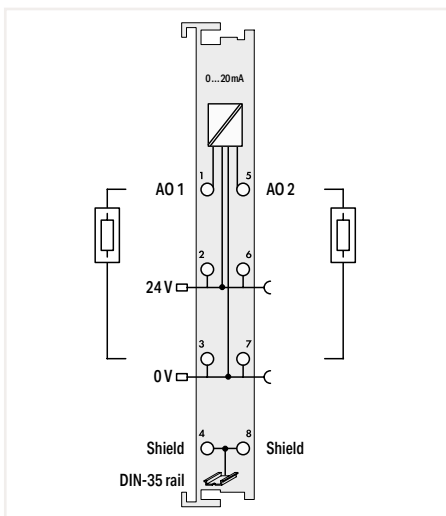

2 Channels; 750-552

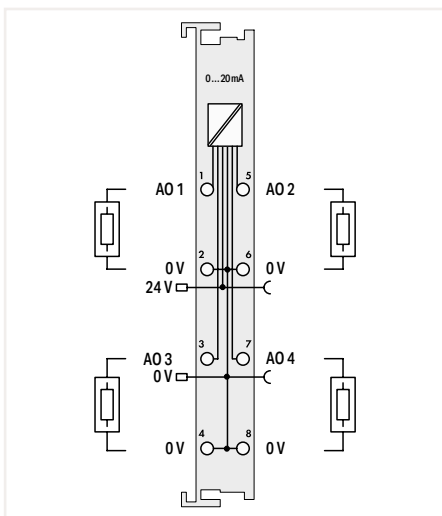

4 Channels; 750-553

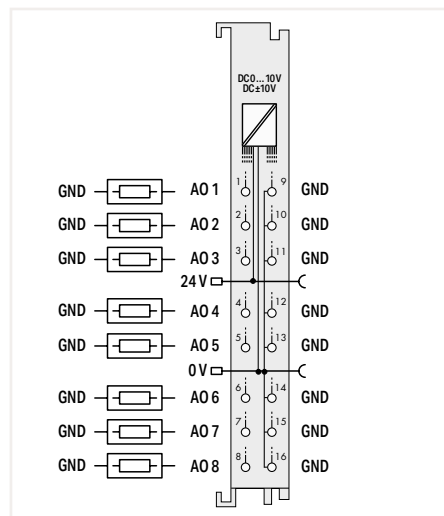

8 Channels; 750-597

## WAGO I/O System – 750/753 Series

### Analog Output Modules

Function	2-Channel AO	4-Channel AO	8-Channel AO	Description	Item Number			
					Standard	/S5 Customized Data Format	Ext. Temperature	Pluggable
0 ... 20 mA	<input checked="" type="checkbox"/>			2-Channel Analog Output; 0 ... 20 mA	750-552	750-552/000-200	750-552/025-000	753-552
		<input checked="" type="checkbox"/>		4-Channel Analog Output; 0 ... 20 mA	750-553			753-553
4 ... 20 mA	<input checked="" type="checkbox"/>			2-Channel Analog Output; 4 ... 20 mA	750-554	750-554/000-200	750-554/025-000	753-554
		<input checked="" type="checkbox"/>		4-Channel Analog Output; 4 ... 20 mA	750-555			753-555
0/4 ... 20 mA	<input checked="" type="checkbox"/>			2-Channel Analog Output; 0/4 ... 20 mA; 16 bits; 6 ... 18 VDC	750-563			
0 ... 10 V	<input checked="" type="checkbox"/>			2-Channel Analog Output; 0 ... 10 VDC	750-550	750-550/000-200		753-550
	<input checked="" type="checkbox"/>			2-Channel Analog Output; 0 ... 10 VDC; 10 bits; 100 mW/24 V	750-560			
		<input checked="" type="checkbox"/>		4-Channel Analog Output; 0 ... 10 VDC	750-559		750-559/025-000	753-559
±10 V	<input checked="" type="checkbox"/>			2-Channel Analog Output; ±10 VDC	750-556	750-556/000-200		753-556
		<input checked="" type="checkbox"/>		4-Channel Analog Output; ±10 VDC	750-557			753-557
0 ... 10 V/±10 V	<input checked="" type="checkbox"/>			2-Channel Analog Output; 0 ... 10 VDC/±10 V; 16 bits	750-562			
			<input checked="" type="checkbox"/>	8-Channel Analog Output; 0 ... 10 VDC/±10 V	750-597			
±5 V/±10 V/±12 V; ±10 mA/±12 mA/ ±20 mA/±22 mA/		<input checked="" type="checkbox"/>		4-Channel Analog Output; ±5 VDC / ±10 VDC / ±12 VDC; ±10 mA/±12 mA/±20 mA/±22 mA/	750-564			

## Function/technology modules



## Communication modules



### 750 Series Housing Design

Dimensions (W x H x D)	Housing with 4 LEDs: 12 x 69.8 x 100 mm Housing with 8 LEDs: 12 x 67.8 x 100 mm
Height from upper-edge of DIN-rail	Housing with 4 LEDs: 62.6 mm Housing with 8 LEDs: 60.6 mm
Connection technology	CAGE CLAMP®
Conductor cross-section	0.08 ... 2.5 mm <sup>2</sup> / 28 ... 14 AWG
Strip length	8 ... 9 mm / 0.33 inch

### 753 Series Housing Design

Dimensions (W x H x D)	Housing with 4 LEDs: 12 x 69.8 x 100 mm Housing with 8 LEDs: 12 x 69 x 100 mm
Height from upper-edge of DIN-rail	Housing with 4 LEDs: 62.6 mm Housing with 8 LEDs: 61.8 mm
Connection technology	CAGE CLAMP®
Conductor cross-section	0.08 ... 2.5 mm <sup>2</sup> / 28 ... 14 AWG
Strip length	9 ... 10 mm / 0.37 inch

### 750 Series Housing Design, Double Width

Dimensions (W x H x D)	24 x 69.8 x 100 mm
Height from upper-edge of DIN-rail	62.6 mm

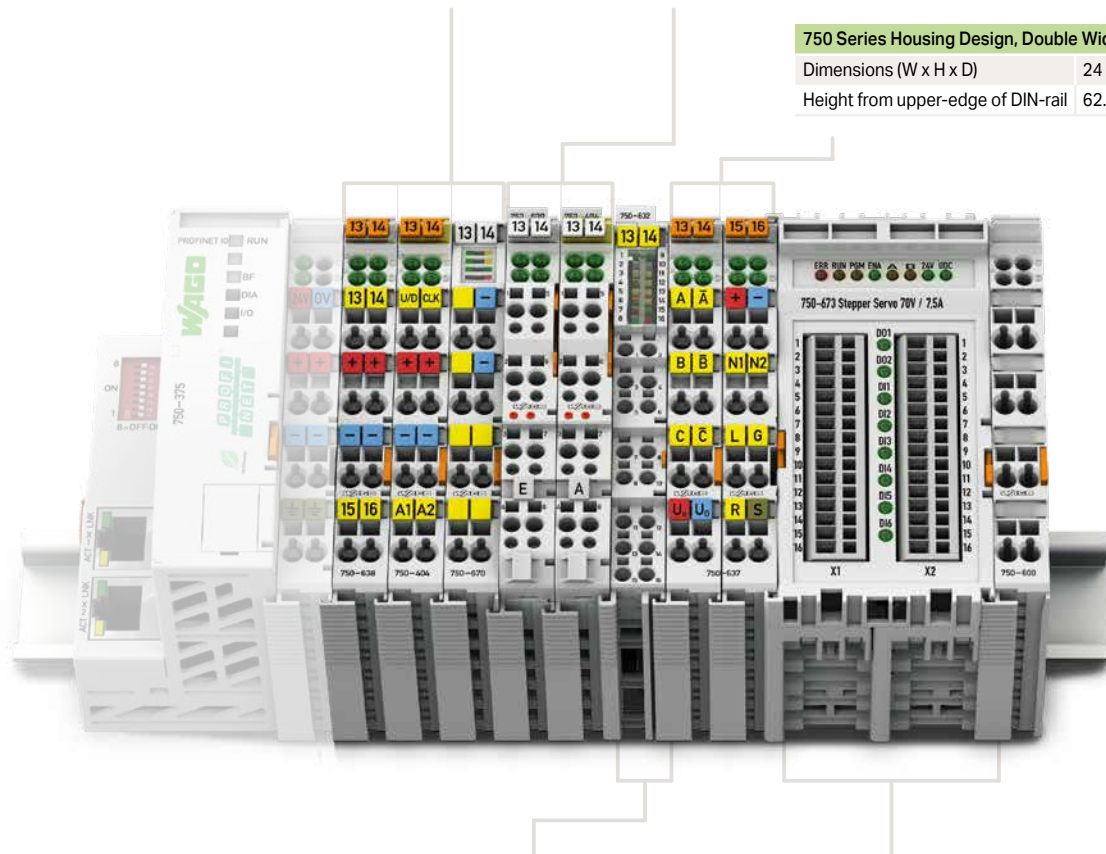

### 750 Series housing design, with Push-in CAGE CLAMP® connections (up to 16 connection points)

Dimensions (W x H x D)	12 x 69 x 100 mm
Height from upper-edge of DIN-rail	61.8 mm
Connection technology	Push-in CAGE CLAMP®
Conductor cross-section	Solid: 0.08 ... 1.5 mm <sup>2</sup> / 28 ... 16 AWG Fine-stranded: 0.25 ... 1.5 mm <sup>2</sup> / 22 ... 16 AWG
Strip length	8 ... 9 mm / 0.33 inch

### Specialty Housing

Dimensions (W x H x D)	51 x 69.8 x 100 mm
Height from upper-edge of DIN-rail	62.6 mm
Connection technology	CAGE CLAMP®
Conductor cross-section	0.08 ... 1.5 mm <sup>2</sup> / 28 ... 14 AWG
Strip length	5 ... 6 mm / 0.22 inch

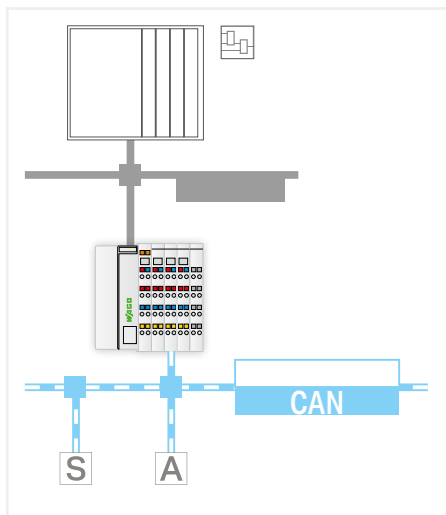

750-658

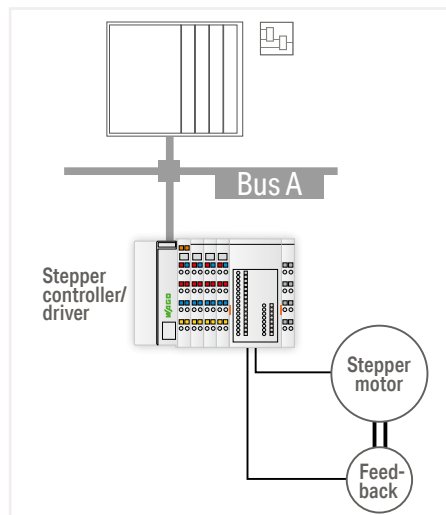

750-673

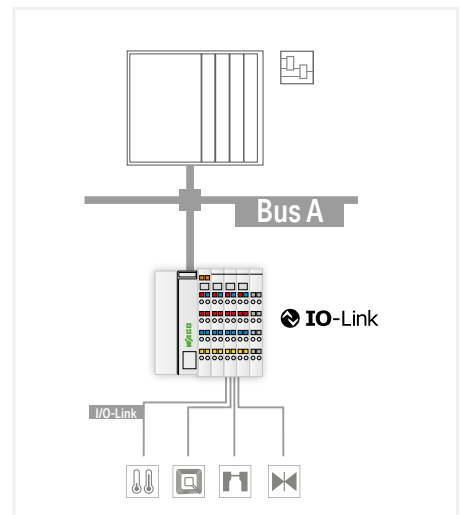

750-657

6









## WAGO I/O System – 750/753 Series

### Function/Technology Modules; Communication Modules

Function	Description	Item Number		
		Standard	Ext. Temperature	Pluggable
Counter	Up/Down Counter	750-404		753-404
	Up Counter; release input	750-404/000-001		
	Frequency Counter	750-404/000-003		753-404/000-003
	Up/Down Counter; switch output	750-404/000-004		
	2 Up Counters; 16 bits	750-404/000-005		753-404/000-005
Pulse Width Output	2 Up/Down Counters; 16 bits; 500 Hz	750-638	750-638/025-000	753-638
	2 Pulse Width Outputs; 24 VDC; 0.1 A; 250 kHz	750-511		753-511
	2 Pulse Width Outputs; 24 VDC; 0.1 A; 2 kHz; frequency counter	750-511/000-001		
Distance and Angle Measurement	2 Pulse Width Outputs; 24 VDC; 0.1 A; 100 Hz	750-511/000-002		
	SSI Transmitter Interface; 24 bits; 125 kHz; gray code	750-630		
	SSI Transmitter Interface; adjustable	750-630/003-000		
	Incremental Encoder Interface; RS-422; 32 bits	750-637		
	Incremental Encoder Interface; 24 VDC; differential input; 32 bits	750-637/000-001		
	Incremental Encoder Interface; 24 VDC; single-ended; 32 bits	750-637/000-002		
	Incremental Encoder Interface; 5 VDC; 32 bits; single evaluation	750-637/000-003		
Vibration Monitoring	Incremental Encoder Interface; 24 VDC; single-ended; 32 bits; cam output	750-637/000-004		
	Digital Impulse Interface	750-635		753-635
Stepper Module	2-Channel Vibration Velocity/Bearing Condition Monitoring, VIB I/O	750-645		
DC Drive Controller	Stepper Controller; RS-422/24 VDC; 20 mA	750-670		
	Stepper Controller; 24 VDC; 1.5 A	750-671		
	Stepper Controller; 70 VDC; 7.5 A	750-672		
	Servo Stepper Controller; 55 VDC; 7.5 A	750-673		
Proportional Valve Module	DC Drive Controller; 24 VDC; 5 A	750-636	750-636/025-000	
	DC Drive Controller; 24 VDC; 5 A; external motor voltage	750-636/000-700		
	DC Drive Controller; 24 VDC; 5 A; interference-free	750-636/000-800		
	Proportional Valve Module	750-632		
		750-632/000-100		

6

Function	Description	Item Number		
		Standard	Ext. Temperature	Pluggable
Serial Interface	RS-232/-485 Serial Interface	750-652	750-652/025-000	753-652
	EnOcean Radio Receiver	750-642		
	KNX/EIB/TP1 Interface			753-646
	DALI Multi-Master			753-647
LON®	LON® FTT Interface			753-648
	MP-Bus Master	750-643		
	M-Bus Master			753-649
	SMI Master Module; for drives with 230 VAC			753-1630
	SMI Master Module; low voltage			753-1631
	AS-Interface Master	750-655		753-655
IO-Link Master	IO-Link Master	750-657		
CAN Gateway	CAN Gateway	750-658		

# Supply and segment modules

## 750/753 Series Housing Design

Dimensions (W x H x D)	12 x 69.8 x 100 mm
Height from upper-edge of DIN-rail	62.6 mm
Connection technology	CAGE CLAMP®
Conductor cross-section	0.08 ... 2.5 mm <sup>2</sup> / 28 ... 14 AWG
Strip length	750 Series: 8 ... 9 mm / 0.33 inch 753 Series: 9 ... 10 mm / 0.37 inch

## 750 Series housing design, with Push-in CAGE CLAMP® connections (up to 16 connection points)

Dimensions (W x H x D)	12 x 69 x 100 mm
Height from upper-edge of DIN-rail	61.8 mm
Connection technology	Push-in CAGE CLAMP®
Conductor cross-section	Solid: 0.08 ... 2.5 mm <sup>2</sup> / 28 ... 16 AWG Fine-stranded: 0.25 ... 1.5 mm <sup>2</sup> / 22 ... 16 AWG
Strip length	8 ... 9 mm / 0.33 inch

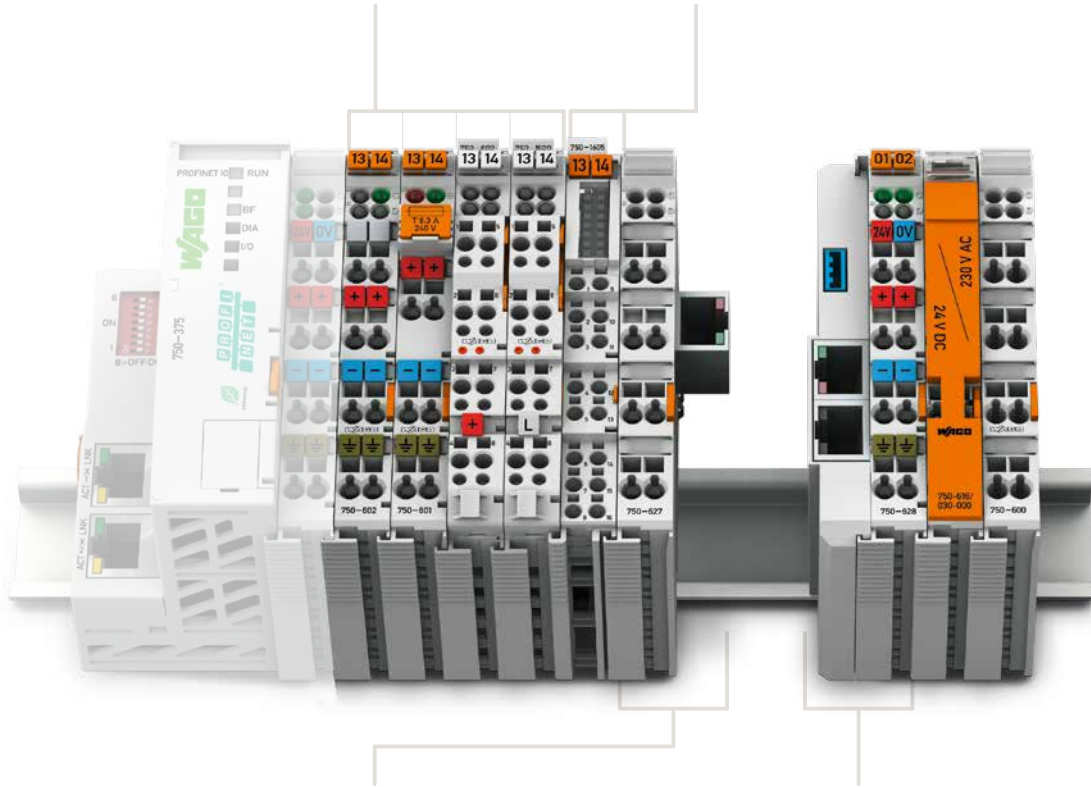

## Specialty Housing, End Module for Bus Extension

Dimensions (W x H x D)	24 x 69.8 x 100
Height from upper-edge of DIN-rail	62.6 mm

## Specialty Housing, Coupler Module for Bus Extension

Dimensions (W x H x D)	24 x 69.8 x 100
Height from upper-edge of DIN-rail	62.6 mm

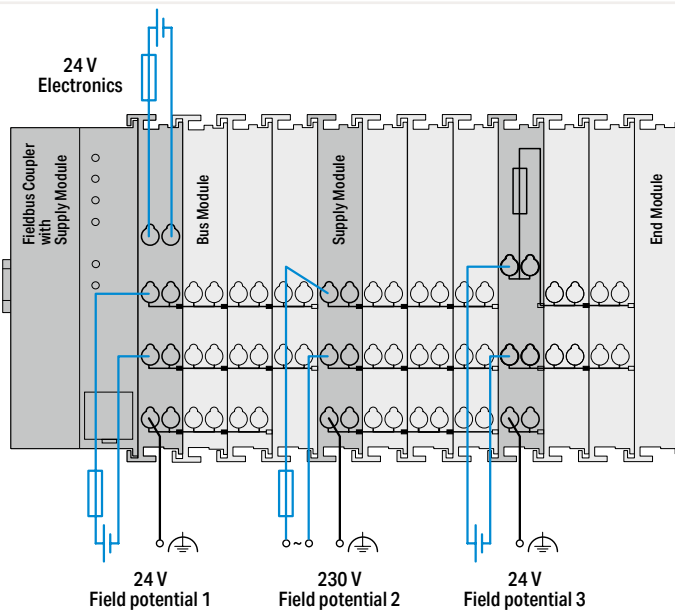

# WAGO I/O System – 750/753 Series

## Supply and segment modules

Function	Description	Item Number		
		Standard	Ext. Temperature	Pluggable
Supply Modules 24 VDC	Supply Module; 24 VDC	750-602	750-602/025-000	753-602
	Supply Module; 24 VDC/5 ... 15 VDC	750-623		
	Supply Module 24 VDC; fuse holder	750-601		
	Supply Module; 24 VDC; fuse holder; diagnostics	750-610		
24 VDC with Bus Power Supply	System Power Supply; 24 VDC	750-613		
230 VAC/VDC	Supply Module; 0 ... 230 VAC/DC	750-612		753-612
24 VAC	Supply Module; 24 VAC; fuse holder	750-617		
120 VAC	Supply Module; 120 VAC; fuse holder	750-615		
230 VAC	Supply Module; 230 VAC; fuse holder	750-609		
	Supply Module; 230 VAC; fuse holder; diagnostics	750-611		
DALI Multi-Master DC/DC Converter	DALI Multi-Master DC/DC Converter			753-620
Potential Distribution	Potential Distribution	750-614		753-614
	Potential Distribution; 8-way 24 V	750-603		753-603
	Potential Distribution; 8-way 0 V	750-604		753-604
	Potential Distribution; 16-way 24 V	750-1605		
	Potential Distribution; 16-way 0 V	750-1606		
	Potential Distribution; 8-way 24 V/8-way 0 V	750-1607		
Filter Module	Field Supply Filter (Surge); 24 VDC; higher isolation	750-624/020-000		
	Field Supply Filter (Surge); 24 VDC; higher isolation; without power jumper contacts	750-624/020-001		
	Field Supply Filter (Surge); 24 VDC; higher isolation; ground fault diagnostics	750-624/020-002		
	Field Supply Filter (Surge); 24 VDC	750-624		
	Field Supply Filter (Surge); 24 VDC; without power jumper contacts	750-624/000-001		
	Filter Module; 24 VDC; higher isolation	750-626/020-000	750-626/025-001	
	Filter Module; 24 VDC; higher isolation; ground fault diagnostics	750-626/020-002		
Local Bus Extension	Bus Extension End Module	750-627		
	Bus Extension Coupler Module	750-628		
Placeholder Module	Binary Placeholder Module	750-622		
	Spacer Module; active			753-1629
	Spacer Module; active; without power jumper contacts			753-1629/000-001
	Spacer Module; passive			753-629/020-000
Distance Module	Distance Module	750-616		
	Distance Module; 24 VDC/230 VAC	750-616/030-000		
	Distance Module	750-621		
End Module	End Module	750-600	750-600/025-000	

6

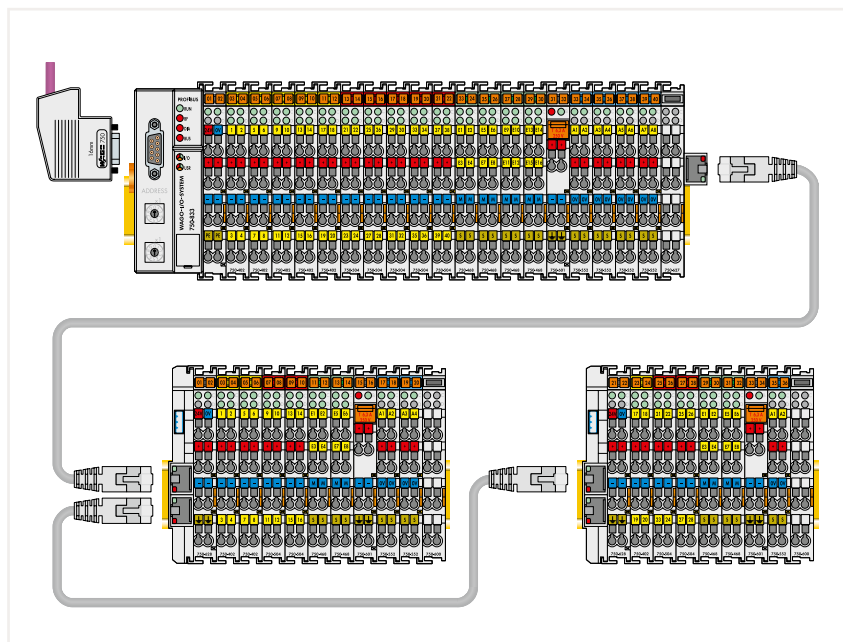

Local Bus Extension

# WAGO I/O System – 750/753 Series

## Functional safety

Function	4 Channels, DI	8 Channels, DI	Description	Item Number	
				Standard	Pluggable
PROFIsafe Fail-Safe Digital Input	<input type="checkbox"/>	<input type="checkbox"/>	Fail-Safe Digital Input; 8 channels; 24 VDC; PROFIsafe	750-660/000-001	
	<input type="checkbox"/>	<input type="checkbox"/>	Fail-Safe Digital Input; 4 channels; 24 VDC; PROFIsafe V 2.0 iPar	750-661/000-003	753-661/000-003
	<input type="checkbox"/>	<input type="checkbox"/>	Fail-Safe Digital Input; 8 channels; 24 VDC; PROFIsafe V 2.0 iPar	750-662/000-003	753-662/000-003
PROFIsafe Fail-Safe Digital Inputs/ Output	<input type="checkbox"/>	<input type="checkbox"/>	Fail-Safe Digital Input/Output; 4/4 channels; 24 VDC; 0.5 A; PROFIsafe	750-665/000-001	
	<input type="checkbox"/>	<input type="checkbox"/>	Fail-Safe Digital Input/Output; 4/2 channels; 24 VDC; 10 A; PROFIsafe V 2.0 iPar	750-666/000-003	753-666/000-003
	<input type="checkbox"/>	<input type="checkbox"/>	Fail-Safe Digital Input/Output; 4/4 channels; 24 VDC; 2 A; PROFIsafe V 2.0 iPar	750-667/000-003	753-667/000-003
	<input type="checkbox"/>	<input type="checkbox"/>	Fail-Safe Digital Input/Relay Output; 4/4 channels; 48 VAC / 60 VDC; 6 A; PROFIsafe V 2.0 iPar	750-669/000-003	
Intrinsically Safe Digital Input for Functional Safety	<input type="checkbox"/>	<input type="checkbox"/>	Intrinsically Safe 4-Channel Digital Input; 24 VDC; PROFIsafe V 2.0 iPar	750-663/000-003	
PROFIsafe Fail-Safe Analog Input	<input type="checkbox"/>	<input type="checkbox"/>	Fail-Safe Analog Input; 4 channels; 0/4 ... 20 mA; PROFIsafe	750-668/000-004	753-668/000-004
Ex i Power Supply	Classification of binary 24 V interfaces with testing in the field of functional safety according to position paper CB24I of ZVEI (German Electrical and Electronic Manufacturer's Association)				
	The intrinsically safe I/O module with inputs for functional safety (750-663/000-003) must only be operated with an Ex i 24 VDC power supply (e.g., 750-606, 750-625/000-001)! General information (e.g., installation regulations) on explosion protection is available in the WAGO I/O System 750 manuals.				
	Supply Module; 24 VDC; diagnostics; intrinsically safe			750-606	
Filter Modules	Supply Module; 24 VDC; intrinsically safe			750-625/000-001	
	The mixed operation of safe and conventional I/O modules streamlines system configuration. For increased electromagnetic immunity (EMC standard), WAGO offers compact power supply filter modules (see Section 4.10). Specific power supply features must be considered, which are described in the corresponding manuals.				
	Field Supply Filter (Surge); 24 VDC; higher isolation			750-624/020-000	
Filter Module; 24 VDC; higher isolation			750-626/020-000		

6

### 750/753 Series Housing Design

Dimensions (W x H x D)	750 Series: 12 or 24 x 67.8 x 100 mm 753 Series: 12 or 24 x 69 x 100 mm
Height from upper-edge of DIN-rail	750 Series: 60.6 mm; 753 Series: 61.8 mm
Connection technology	CAGE CLAMP®
Conductor cross-section	0.08 ... 2.5 mm² / 28 ... 14 AWG
Strip length	750 Series: 8 ... 9 mm / 0.33 inch 753 Series: 9 ... 10 mm / 0.37 inch

### Specialty Housing

Dimensions (W x H x D)	48 x 69.8 x 100
Height from upper-edge of DIN-rail	62.6 mm
Connection technology	Push-in CAGE CLAMP®
Conductor cross-section	0.05 ... 1.5 mm² / 20 ... 14 AWG
Strip length	8 ... 9 mm / 0.33 inch

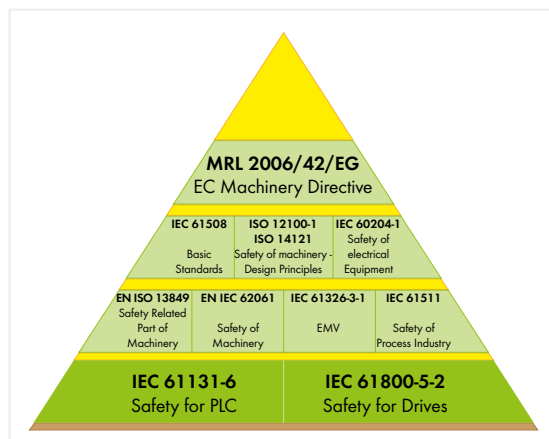
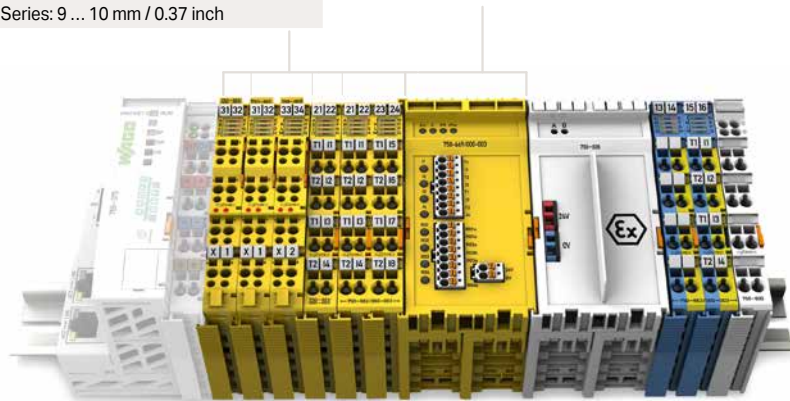

# WAGO I/O System – 750 Series

## Ex i Intrinsically Safe Modules

Function	1 Channel	2 Channels	4 Channels	8 Channels	Description	Item Number
Ex i Power Supply					Supply Module; 24 VDC; diagnostics; intrinsically safe	750-606
					Supply Module; 24 VDC; intrinsically safe	750-625/000-001
Ex i Digital Input for Proximity Sensors per EN 60947-5-6	■				1-Channel Digital Input; NAMUR; intrinsically safe	750-435
		■			2-Channel Digital Input; NAMUR; intrinsically safe	750-438
			■		Intrinsically Safe 4-Channel Digital Input; 24 VDC; PROFIsafe V 2.0 iPar	750-663/000-003
				■	8-Channel Digital Input; NAMUR; intrinsically safe	750-439
Ex i Digital Output		■			2-Channel Digital Output; 24 VDC; intrinsically safe	750-535
			■		4-Channel Digital Output; 24 VDC; Valve; intrinsically safe	750-539
		■			2-Channel Relay Output; changeover contact; potential-free; intrinsically safe	750-538
Ex i Analog Input		■			2-Channel Analog Input; 4 ... 20 mA; intrinsically safe	750-485
			■		4-Channel Analog Input; 0/4 ... 20 mA; NAMUR NE43; intrinsically safe	750-486
		■			2-Channel Analog Input; 4 ... 20 mA HART; intrinsically safe	750-484
		■			2-Channel Analog Input; 4 ... 20 mA HART; NAMUR NE43; intrinsically safe	750-484/000-001
		■			2-Channel Analog Input; RTD; intrinsically safe	750-481/003-000
		■			2-Channel Analog Input; TC; intrinsically safe	750-487/003-000
			■		4-Channel Analog Input; RTD/TC/DMS; intrinsically safe	750-489
		■			2-Channel Analog Output; 0 ... 20 mA; intrinsically safe	750-585
Ex i Analog Output		■			2-Channel Analog Output; 4 ... 20 mA; intrinsically safe	750-586
					Up/Down Counter; intrinsically safe	750-633

### Specialty Housing

Dimensions (W x H x D)	48 x 70.9 x 100
Height from upper-edge of DIN-rail	63.7 mm
Connection technology	CAGE CLAMP®
Conductor cross-section	0.08 ... 1.5 mm² / 28 ... 16 AWG
Strip length	5 ... 6 mm / 0.22 inch

### 750 Series Housing Design

Dimensions (W x H x D)	12 or 24 x 67.8 x 100 mm
Height from upper-edge of DIN-rail	60.6 mm
Connection technology	CAGE CLAMP®
Conductor cross-section	0.08 ... 2.5 mm² / 28 ... 14 AWG
Strip length	8 ... 9 mm / 0.33 inch

6

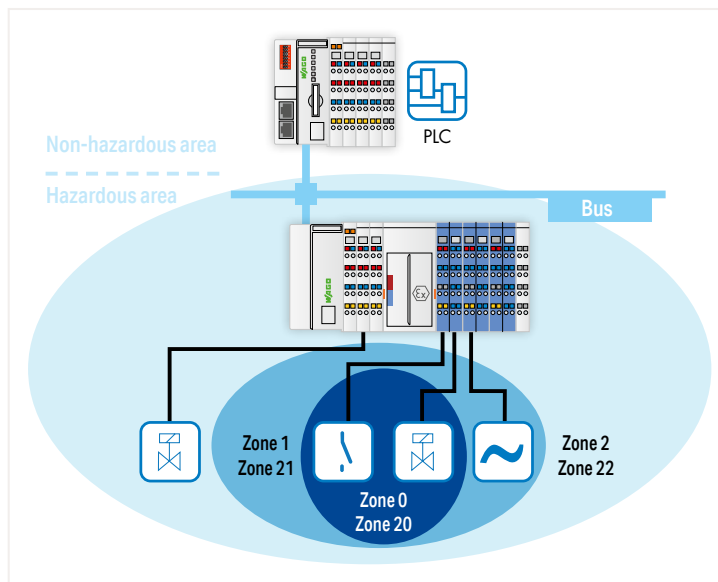
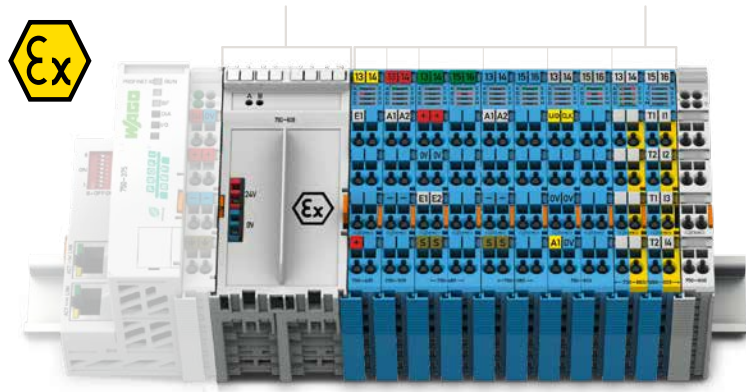

## WAGO I/O System – 750 Series XTR

### General Product Information

#### Taking It to the Extreme – the Standard for 750 XTR

The WAGO I/O System 750 XTR is instantly recognizable by its dark gray modules. You benefit from the unique added value that this system offers in applications in extreme environment conditions.

Its extreme temperature resistance, immunity to interference and vibrations and impulse voltage resistance are excellent features of the WAGO I/O System 750 XTR.

WAGO's 750 XTR is the first choice for demanding applications including:

- Shipbuilding and onshore/offshore industry
- Renewable energy systems (wind turbines, solar systems and biogas plants)
- Transformer stations and power distribution systems
- Petrochemical processing
- Water and wastewater treatment systems
- Custom machines
- Railway applications











#### The Benefit for You:

- No need for air conditioning
  - Requires less space
  - Lower energy and maintenance costs
- Can be used in unshielded areas
- Maximum system uptime
- Use on vibrating/shock-generating system components
- Vibration-proof, fast and maintenance-free CAGE CLAMP® connections

#### General Technical Specifications

System supply voltage	24 VDC (-25 ... +30 %); via power jumper contacts; Specified values for surrounding air temperature: 15 ... 35 °C For -40 ... +55 °C: 24 V (-25 ... +20 %); For 55 ... 70 °C: 24 V (-25 ... +10 %); Lower limit in all temperature ranges: -27.5 % (including 15 % residual ripple)
Supply voltage (system) for intrinsically safe XTR modules	24 VDC via power jumper contacts (Ex i power supply: U <sub>0</sub> = max. 26.8 V)
Surrounding air temperature (operation)	-40 ... +70 °C
Surrounding air temperature (storage)	-40 ... +85 °C
Relative humidity	Max. 95 %; Short-term condensation per class 3K7 / IEC EN 60721-3-3 and E DIN 40046-721-3 (except wind-driven precipitation, water and ice formation)
Operating altitude	Without temperature derating: 0 ... 2000 m; With temperature derating: 2000 ... 5000 m (0.5 K/100 m); max.: 5000 m
Pollution degree	2 per IEC 61131-2
Immunity to impulse voltages	Per EN 60870-2-1 Module ≤ 50 V: 510 VAC/775 VDC; Module > 50 V: 2.5 kVAC/3.5 kVDC Isolation: rated surge voltage Module ≤ 50 V: 1 kV (Class VW1 per EN 60870-2-1) Module > 50 V: 5 kV (Class VW3 per EN 60870-2-1) Intrinsically safe module: 1 kV; 1.5 kV between intrinsically safe and non-intrinsically safe circuits Surge: Module ≤ 50 V: 1 kV (L-L) / 2 kV (L-E) Module > 50 V: 2 kV (L-L) / 4 kV (L-E)
Vibration resistance	• Per IEC 60068-2-6 (acceleration: 5g), EN 60870-2-2, IEC 60721-3-1, -3 • EN 50155; EN 61373 (not for intrinsically safe modules)
Shock resistance	• Per IEC 60068-2-27 (15g/11 ms/half-sine/1,000 shocks; 25g/6 ms/1,000 shocks); EN 61373 • EN 50155 (not for intrinsically safe modules)
EMC immunity to interference	• Per EN 61000-6-1, -2; EN 61131-2; marine applications; EN 60255-26; EN 60870-2-1; EN 61850-3; IEC 61000-6-5; IEEE 1613; VDEW: 1994 • EN 50121-3-2; EN 50121-4, -5 (not for intrinsically safe modules)
EMC emission of interference	• Per EN 61000-6-3, -4; EN 61131-2; EN 60255-26; marine applications; EN 60870-2-1 (industrial and residential areas); EN 61850-3 (industrial and residential areas) • EN 50121-3-2; EN 50121-4, -5 (not for intrinsically safe modules)
Protection class	IP20
Mounting position	Standing/lying horizontal; vertical
Mounting type	DIN-35 rail mounting
Housing material	Polycarbonate; polyamide 6.6
Exposure to pollutants	Per IEC 60068-2-42 and IEC 60068-2-43
Permissible SO <sub>2</sub> contaminant concentration at a relative humidity < 75 %	25 ppm
Permissible H <sub>2</sub> S contaminant concentration at a relative humidity < 75 %	10 ppm
Connection technology	CAGE CLAMP®
Conductor cross-section (standard modules and fieldbus couplers)	0.25 ... 2.5 mm <sup>2</sup> /24 ... 14 AWG
Strip length (standard modules and fieldbus couplers)	8 ... 9 mm / 0.31 ... 0.35 inch
Conductor cross-section (Eco fieldbus coupler and supply module)	0.25 ... 1.5 mm <sup>2</sup> /24 ... 14 AWG
Strip length (Eco fieldbus coupler and supply module)	5 ... 6 mm / 0.2 ... 0.24 inch
Connection technology (I/O modules with 16 connection points)	Push-in CAGE CLAMP®
Conductor cross-section (I/O modules with 16 connection points)	0.25 ... 1.5 mm <sup>2</sup> /24 ... 16 AWG
Strip length (I/O modules with 16 connection points)	8 ... 9 mm / 0.31 ... 0.35 inch
Current carrying capacity of power jumper contacts	10 A; 1 A for all intrinsically safe modules

## WAGO I/O System – 750 Series XTR

Illustrations		1 Channel	2 Channels	4 Channels	8 Channels	16 Channels	Description	Item No.	
	Fieldbus couplers						PROFIBUS DP Fieldbus Coupler; 2nd generation; 12 MBd; XTR	750-333/040-000	
							ETHERNET Fieldbus Coupler; 3rd generation; XTR	750-352/040-000	
							CANopen Fieldbus Coupler; D-sub; XTR	750-338/040-000	
							Modbus TCP Fieldbus Coupler; XTR	750-362/040-000	
							Modbus TCP Fieldbus Coupler; XTR; M12 connection	750-364/040-000	
							EtherNet/IP Fieldbus Coupler; XTR	750-363/040-000	
							EtherNet/IP Fieldbus Coupler; XTR; ; M12 connection	750-365/040-000	
	Digital Input Modules				<input checked="" type="checkbox"/>		8-Channel Digital Input; 24 VDC; 3 ms; 2-wire connector; XTR	750-1415/040-000	
					<input checked="" type="checkbox"/>		8-Channel Digital Input; 24 VDC; 3 ms; XTR	750-430/040-000	
						<input checked="" type="checkbox"/>		16-Channel Digital Input; 24 VDC; 3 ms; XTR	750-1405/040-000
						<input checked="" type="checkbox"/>		8-Channel Digital Input; 24 VDC; 0.2 ms; 2-wire connector; XTR	750-1416/040-000
						<input checked="" type="checkbox"/>		8-Channel Digital Input; 24 VDC; 0.2 ms; XTR	750-431/040-000
			<input checked="" type="checkbox"/>					2-Channel Digital Input; 60 VDC; 3 ms; XTR	750-429/040-001
			<input checked="" type="checkbox"/>					2-Channel Digital Input; 110 VDC; 3 ms; XTR	750-427/040-000
		<input checked="" type="checkbox"/>				2-Channel Digital Input; 220 VDC; 3 ms; XTR	750-407/040-000		
	Digital Output Modules		<input checked="" type="checkbox"/>				2-Channel Digital Output; 24 VDC; 2.0 A; diagnostics, XTR	750-508/040-000	
					<input checked="" type="checkbox"/>		8-Channel Digital Output; 24 VDC; 0.5 A; diagnostics, XTR	750-537/040-000	
						<input checked="" type="checkbox"/>		8-Channel Digital Output; 24 VDC; 0.5 A; 2-wire connection; XTR	750-1515/040-000
				<input checked="" type="checkbox"/>				2-Channel Relay Output; 250 VAC; 1 A; relay with 2 changeover contacts; XTR	750-517/040-000
	Analog Input Modules			<input checked="" type="checkbox"/>			4-Channel Analog Input; 0 ... 20 mA; single-ended; XTR	750-453/040-000	
				<input checked="" type="checkbox"/>			4-Channel Analog Input; 4 ... 20 mA; single-ended; XTR	750-455/040-000	
				<input checked="" type="checkbox"/>			2-Channel Analog Input; 4 ... 20 mA; differential input; NAMUR NE 43; XTR	750-492/040-001	
					<input checked="" type="checkbox"/>			4-Channel Analog Input, 0 ... 10 VDC; single-ended; XTR	750-468/040-000
					<input checked="" type="checkbox"/>			4-channel analog input, ±10 VDC; single-ended; XTR	750-457/040-000
				<input checked="" type="checkbox"/>				2-Channel Analog Input; 0 ... 30 VDC; differential Input; XTR	750-483/040-000
				<input checked="" type="checkbox"/>	<input checked="" type="checkbox"/>			2/4-Channel Analog Input; resistance measurement; adjustable; XTR	750-464/040-000
				<input checked="" type="checkbox"/>				2-Channel Analog Input; thermocouple; adjustable; XTR	750-469/040-000
								3-Phase Power Measurement; 690 VAC 1 A; XTR	750-495/040-000
								3-Phase Power Measurement; 690 VAC 5 A; XTR	750-495/040-001
						3-Phase Power Measurement; 690 VAC; Rogowski coils; XTR	750-495/040-002		
	Analog Output Modules		<input checked="" type="checkbox"/>				2-Channel Analog Output; 0/4 ... 20 mA; 16 bits; 6 ... 18 VDC; XTR	750-563/040-000	
					<input checked="" type="checkbox"/>			4-Channel Analog Output; ±10 VDC; XTR	750-557/040-000
					<input checked="" type="checkbox"/>			4-Channel Analog Output; 0 ... 10 VDC; XTR	750-559/040-000
	Function/Technology/Communication Modules	<input checked="" type="checkbox"/>					Counter; adjustable; XTR	750-404/040-003	
		<input checked="" type="checkbox"/>					SSI Transmitter Interface; adjustable; XTR	750-630/040-001	
		<input checked="" type="checkbox"/>					Incremental Encoder Interface; 24 VDC; differential Input; 32 bits; XTR	750-637/040-001	
		<input checked="" type="checkbox"/>					RS-232/485 Serial Interface; XTR	750-652/040-000	
		<input checked="" type="checkbox"/>					CAN Gateway; XTR	750-658/040-000	
	Supply/Segment Modules						Supply Module; 24 VDC; XTR	750-602/040-000	
							Supply Module; 24 VDC; fuse holder; XTR	750-601/040-000	
							Supply Module; 24 VDC; fuse holder; diagnostics; XTR	750-610/040-000	
							Supply Module; 0 ... 230 VAC/VDC; XTR	750-612/040-000	
							System Supply Module; 24 VDC; XTR	750-613/040-000	
							Potential Distribution; 16-way 24 V; XTR	750-1605/040-000	
							Potential Distribution; 16-way 0 V; XTR	750-1606/040-000	
							Field-Side Connection Module; 0 ... 230 VAC/VDC; XTR	750-614/040-000	
							Field-Side Power Supply Filter (Surge); 24 VDC; higher isolation; XTR	750-624/040-000	
							Field-Side Power Supply Filter (Surge); 24 VDC; higher isolation; without power jumper contacts; XTR	750-624/040-001	
							Filter Module; 24 VDC; higher isolation; XTR	750-626/040-000	
							Distance Module; XTR	750-616/040-000	
							End Module; XTR	750-600/040-000	
	Intrinsically Safe XTR Modules				<input checked="" type="checkbox"/>		Supply Module; 24 VDC; XTR; for intrinsically safe XTR modules	750-606/040-000	
					<input checked="" type="checkbox"/>		8-Channel Digital Input; NAMUR; intrinsically safe; XTR	750-439/040-000	
			<input checked="" type="checkbox"/>					2-Channel Digital Output; 24 VDC; intrinsically safe; XTR	750-535/040-000
					<input checked="" type="checkbox"/>			4-Channel Analog Input; 0/4 ... 20 mA; intrinsically safe; XTR	750-486/040-000
				<input checked="" type="checkbox"/>				2-Channel Analog Input; 4 ... 20 mA HART; intrinsically safe; XTR	750-484/040-000
				<input checked="" type="checkbox"/>				2-Channel Analog Input; resistance measurement; intrinsically safe; XTR	750-481/040-000
			<input checked="" type="checkbox"/>			2-Channel Analog Output; 0 ... 20 mA; intrinsically safe; XTR	750-585/040-000		
						Up/Down Counter; intrinsically safe; XTR	750-633/040-000		

# WAGO I/O System Field Interfaces and Types

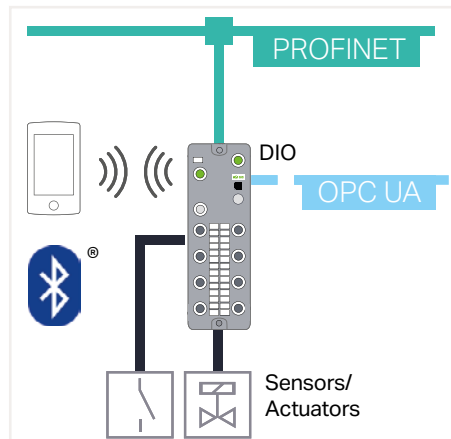

Fieldbus Module as PROFINET Device

- 16 DIs, 16 DOs or 16 DIOs, with M12, A-coded, 5-pole
- 8 DIOs with M12, A-coded, 5-pole or M8; 3-pole

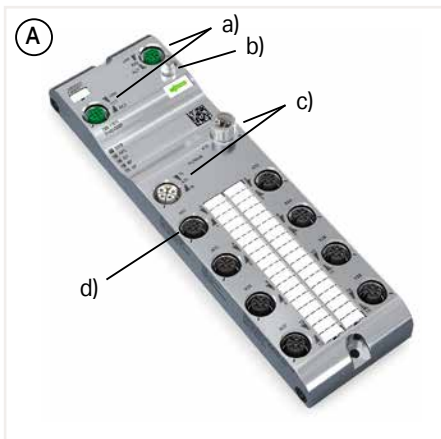

Housing Design (A)

- Fieldbus: 2 x M12, D-coded, 5-pole (a)
- Bluetooth® (b)
- Supply: M12, L-coded, 5-pole (c)
- Inputs/outputs: M12, A-coded, 5-pole (d)
- W x H x D (mm): 60 x 30 x 210

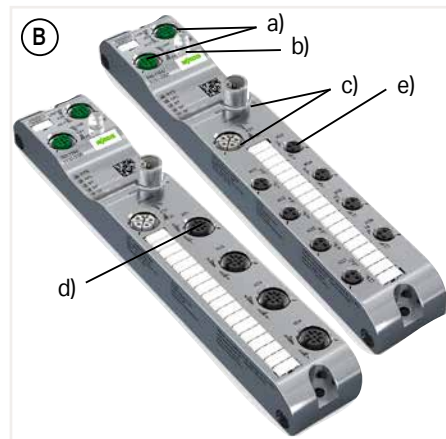

Housing Design (B)

- Fieldbus: 2 x M12, D-coded, 5-pole (a)
- Bluetooth® (b)
- Supply: M12, L-coded, 5-pole (c)
- Inputs/outputs: M12, A-coded, 5-pole (d) or M8, 3-pole (e)
- W x H x D (mm): 35 x 30 x 210

6

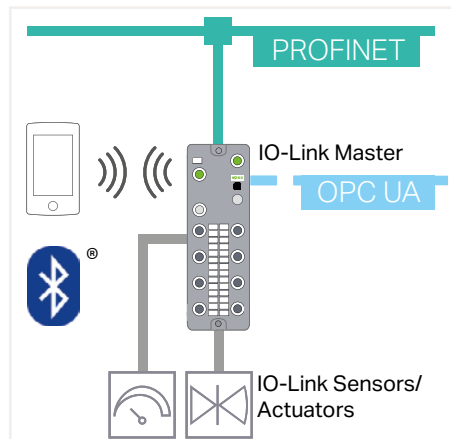

IO-Link Master as PROFINET Device

- with M12, A-coded, 5-pole
- 8 or 4 IO-Link ports, class A
- 8 or 4 IO-Link ports, class B

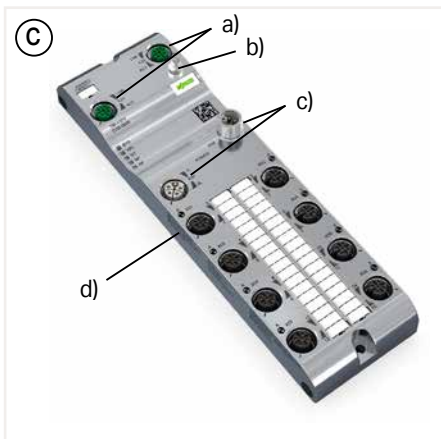

Housing Design (C)

- Fieldbus: 2 x M12, D-coded, 5-pole (a)
- Bluetooth® (b)
- Supply: M12, L-coded, 5-pole (c)
- IO-Link Ports: M12, A-coded, 5-pole (d)
- W x H x D (mm): 60 x 30 x 210

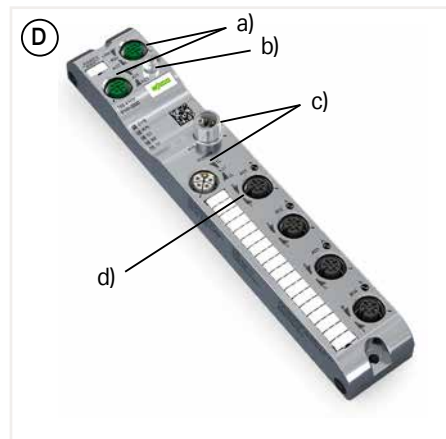

Housing Design (D)

- Fieldbus: 2 x M12, D-coded, 5-pole (a)
- Bluetooth® (b)
- Supply: M12, L-coded, 5-pole (c)
- IO-Link Ports: M12, A-coded, 5-pole (d)
- W x H x D (mm): 35 x 30 x 210

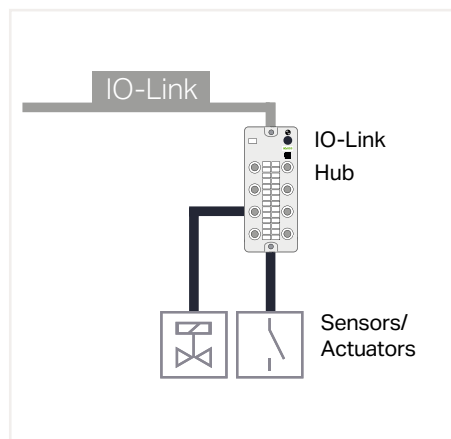

IO-Link Hub

- 16 DIOs, with M12, A-coded, 5-pole
- 8 DIOs with M12, A-coded, 5-pole or M8; 3-pole

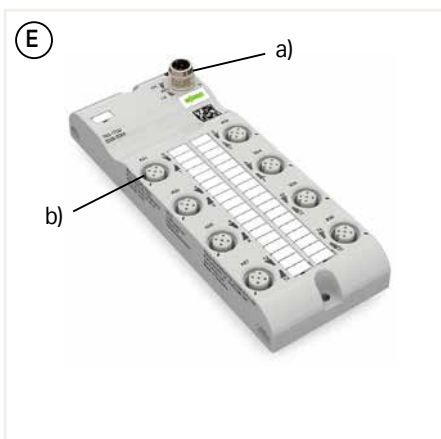

Housing Design (E)

- IO-Link hub: M12, A-coded, 5-pole (a)
- Inputs/outputs: M12, A-coded, 5-pole (b)
- W x H x D (mm): 60 x 30 x 158.5

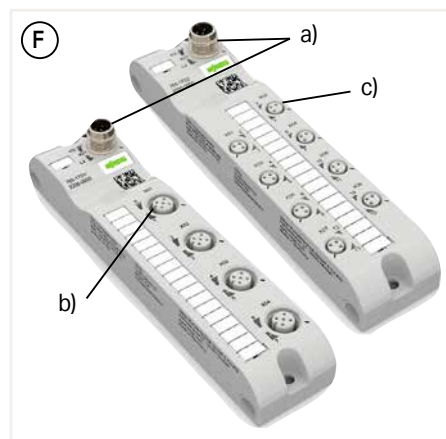

Housing Design (F)

- IO-Link hub: M12, A-coded, 5-pole (a)
- Inputs/outputs: M12, A-coded, 5-pole (b) or M8, 3-pole (c)
- W x H x D (mm): 35 x 30 x 158.5



# WAGO I/O System Field – 765 Series Interfaces and Types













Figure	Description	Communication Interface	Number of M12 Connections	Digital Inputs/Outputs			Item Number
				Inputs	Outputs	Inputs/Outputs	
	16-Channel Digital Output; PROFINET device; 24 VDC	PROFINET	8	16			765-1101/100-000
	16-Channel Digital Output; PROFINET device; 24 VDC	PROFINET	8		16		765-1103/100-000
	16-Channel Digital Input/Output; PROFINET device; 24 VDC	PROFINET	8			16	765-1102/100-000
	8-Channel Digital Input/Output; PROFINET device; 24 VDC	PROFINET	4			8	765-1104/100-000
	8-Channel Digital Input/Output; PROFINET device; 24 VDC	PROFINET	8			8	765-1105/100-000
	8-Port IO-Link Master, Class A; PROFINET; 24 VDC / 2 A	PROFINET	8			16	765-4101/100-000
	8-Port IO-Link Master, Class B; PROFINET; 24 VDC / 2 A	PROFINET	8			16	765-4102/100-000
	8-Port IO-Link Master, Class A; PROFINET; 24 VDC / 2 A	PROFINET	4			8	765-4103/100-000
	8-Port IO-Link Master, Class B; PROFINET; 24 VDC / 2 A	PROFINET	4			8	765-4104/100-000
	8-Channel Digital Input/Output; IO-Link class A hub; 24 VDC / 2 A	IO-Link Class A Slave	4			8	765-1701/200-000
	8-Channel Digital Input/Output; IO-Link class B hub; 24 VDC / 2 A	IO-Link Class B Slave	4			4	765-1704/200-000
	8-Channel Digital Input/Output; IO-Link class A hub; 24 VDC / 2 A	IO-Link Class A Slave	8			8	765-1702/200-000
	8-Channel Digital Input/Output; IO-Link class B hub; 24 VDC / 2 A	IO-Link Class B Slave	8			4	765-1705/200-000
	16-Channel Digital Input/Output; IO-Link class A hub; 24 VDC / 2 A	IO-Link Class A Slave	8			16	765-1703/200-000
	16-Channel Digital Input/Output; IO-Link class B hub; 24 VDC / 2 A	IO-Link Class B Slave	8			8	765-1706/200-000

6













Cable Length						
<b>Power Cable; L-coded; 5-pole</b>						
0.3 m					<input type="radio"/> 756-3505/050-003	<input type="radio"/> 756-3506/050-003
0.5 m					<input type="radio"/> 756-3505/050-005	<input type="radio"/> 756-3506/050-005
1 m					<input type="radio"/> 756-3505/050-010	<input type="radio"/> 756-3506/050-010
2 m	<input type="radio"/> 756-3501/050-020	<input type="radio"/> 756-3502/050-020	<input type="radio"/> 756-3503/050-020	<input type="radio"/> 756-3504/050-020	<input type="radio"/> 756-3505/050-020	<input type="radio"/> 756-3506/050-020
5 m	<input type="radio"/> 756-3501/050-050	<input type="radio"/> 756-3502/050-050	<input type="radio"/> 756-3503/050-050	<input type="radio"/> 756-3504/050-050	<input type="radio"/> 756-3505/050-050	<input type="radio"/> 756-3506/050-050
7,5	<input type="radio"/> 756-3501/050-075	<input type="radio"/> 756-3502/050-075	<input type="radio"/> 756-3503/050-075	<input type="radio"/> 756-3504/050-075	<input type="radio"/> 756-3505/050-075	<input type="radio"/> 756-3506/050-075
10 m	<input type="radio"/> 756-3501/050-100	<input type="radio"/> 756-3502/050-100	<input type="radio"/> 756-3503/050-100	<input type="radio"/> 756-3504/050-100	<input type="radio"/> 756-3505/050-100	<input type="radio"/> 756-3506/050-100
15 m	<input type="radio"/> 756-3501/050-150	<input type="radio"/> 756-3502/050-150	<input type="radio"/> 756-3503/050-150	<input type="radio"/> 756-3504/050-150	<input type="radio"/> 756-3505/050-150	<input type="radio"/> 756-3506/050-150
<b>ETHERNET/PROFINET Cable; D-coded; 4-pole</b>						
2 m	<input checked="" type="radio"/> 756-1201/060-020	<input checked="" type="radio"/> 756-1202/060-020			<input checked="" type="radio"/> 756-1203/060-020	<input checked="" type="radio"/> 756-1204/060-020
5 m	<input checked="" type="radio"/> 756-1201/060-050	<input checked="" type="radio"/> 756-1202/060-050			<input checked="" type="radio"/> 756-1203/060-050	<input checked="" type="radio"/> 756-1204/060-050
10 m	<input checked="" type="radio"/> 756-1201/060-100	<input checked="" type="radio"/> 756-1202/060-100			<input checked="" type="radio"/> 756-1203/060-100	<input checked="" type="radio"/> 756-1204/060-100
20 m	<input checked="" type="radio"/> 756-1201/060-200	<input checked="" type="radio"/> 756-1202/060-200			<input checked="" type="radio"/> 756-1203/060-200	<input checked="" type="radio"/> 756-1204/060-200

Accessories		
Figure	Description	Item No.
	Marking Strip; on reel; not stretchable; plain; snap-on type; white	2009-110
	WMB Inline; for Smart Printer; 1,500 on reel; stretchable from 5 to 5.2 mm; plain; snap-on type; white	2009-115

## Accessories For WAGO I/O System

Figure	Description	Item No.	Pack. Unit
	○ Plug for 753 Series; light gray	753-110	25
	● Plug for 753 Series; yellow	753-120	25
	● Coding Keys; for 753 Series; red	753-150	100
	○ Marker Carrier; for 750/753 Series; transparent	750-103	50
	○ Marker Carrier; for 750/753 Series; 4 LEDs; transparent	750-106	50
	○ Marker Carrier; for 750/753 Series; 8 LEDs; transparent	750-107	50
	○ Marker Card; as DIN A4 sheet; plain; 160 markers/sheet; white	750-100	1
	WAGO Mini Quick Marking System (Mini-WSB); as card; plain; 10 strips with 10 markers/card		
	○ White	248-501	5
	● Yellow	248-501/000-002	5
	● Red	248-501/000-005	5
	● Blue	248-501/000-006	5
	○ Gray	248-501/000-007	5
	● Orange	248-501/000-012	5
	○ Light green	248-501/000-017	5
	● Green	248-501/000-023	5
	● Violet	248-501/000-024	5
	Operating Tool; with partially insulated shaft; type 1; blade: (2.5 x 0.4) mm	210-719	1
	Operating Tool; with partially insulated shaft; type 2; blade: (3.5 x 0.5) mm	210-720	1
	Interface module for system wiring; relay module with miniature switching relay; pluggable connector per DIN 41651	Full Line Catalog, volume 4 or www.wago.com.	
	System Cable; for WAGO I/O System, 753 Series; 8 digital inputs or outputs; length: 2 m	706-7753/300-200	1
	System Cable; for WAGO I/O System, 750 Series; 2 x 8 digital inputs or outputs; length: 2 m	706-7753/304-200	1
	ETHERNET Plug; RJ45; IP20; ETHERNET 10/100 Mbit/s; for field assembly; cat. 5; straight; code T568A	750-975	1
	ETHERNET Plug; RJ45; IP20; cat. 6A; straight; code T568A	750-977/000-011	1
	ETHERNET Plug; RJ45; IP20; cat. 6A; straight; code T568B	750-977/000-012	1
	ETHERNET Plug; RJ45; IP20; cat. 6A; straight; code T568A; strain relief	750-978/000-011	1
	ETHERNET Plug; RJ45; IP20; cat. 6A; straight; code T568B; strain relief	750-978/000-012	1
	ETHERNET Plug; RJ45; IP20; cat. 6A; angled; code T568A; strain relief	750-979/000-011	1
	ETHERNET Plug; RJ45; IP20; cat. 6A; angled; code T568B; strain relief	750-979/000-012	1
	PROFINET Connector; RJ45; cat. 6A; straight; 22 AWG	750-977/000-013	1
	PROFINET Connector; RJ45; cat. 6A; straight; 22 AWG; strain relief	750-978/000-013	1
	PROFINET Connector; RJ45; cat. 6A; angled; AWG 22; strain relief	750-979/000-013	1
	PROFINET RJ45 plug, IP20; ETHERNET 10/100 Mbit/s; for field assembly	750-976	1

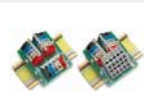
## Accessories For WAGO I/O System

Figure	Description	Item No.	Pack. Unit
	PROFIBUS Fieldbus Connector; sub-D plug; 9-pole	750-960	1
	PROFIBUS Fieldbus Connector; with sub-D plug; 9-pole; suitable for S7 PLC	750-971	1
	PROFIBUS Fieldbus Connector; with sub-D plug and socket; 9-pole; suitable for S7 PLC	750-972	1
	CANopen Fieldbus Connector; with D-sub socket; 9-pole	750-963	1
	INTERBUS Fieldbus Connector (IN); with D-sub socket; 9-pole	750-961	1
	INTERBUS Fieldbus Connector (OUT); with D-sub plug; 9-pole	750-962	1
	CC-Link Fieldbus Connector; with D-sub plug; 9-pole	750-965	1
	Configuration Cable; USB connection; length: 2.5 mm	750-923	1
	Configuration Cable; USB connection; length: 5 mm	750-923/000-001	1
	Wireless ETHERNET Gateway; for ETHERNET protocols like PROFINET, Modbus/TCP, Ethernet/IP; integrated antenna	758-918	1
	Wireless ETHERNET Gateway; for ETHERNET protocols like PROFINET, Modbus/TCP, Ethernet/IP; external antenna	758-918/000-001	1
	Wireless Access Point; for WLAN/Bluetooth®	758-919	1
	Magnetic-Mount Antenna; GSM 900/1800; external antenna	758-910	1
	Magnetic-Mount Antenna; 2.4 GHz WLAN/Bluetooth®; external antenna	758-912	1
	Magnetic-Mount Antenna; GSM/UMTS/LTE/Bluetooth®/WLAN; 2.7 GHz; external antenna	758-975	1
	DeviceNet Multi Port Device Tap; 2 trunk cables (input, output); 4 drop cables; IP65/NEMA 4 housing	810-900/000-001	1
	Multi Port Device Tap; 2 trunk cables (input, output); 2 drop cables; open design	810-901/000-001	1
	Multi Port Device Taps with Mounting Foot; 2 trunk cables (input, output); 1 drop cable; open design	810-902/000-001	1
	Multi Port Device Taps with Mounting Foot; 2 trunk cables (input, output); 2 drop cables; open design	810-902/000-002	1
	CF Memory Card; SLC NAND; 1000 MB; temperature: -40 ... 85 °C	758-879/000-000	1
	SD Memory Card; SLC NAND, 2 GB; temperature: -40 ... 90 °C	758-879/000-001	1
	SD Memory Card; pSLC NAND, 8 GB; temperature: -40 ... 85 °C	758-879/000-2108	1
	MicroSD Memory Card; 2 GB; temperature: -40 ... 85 °C	758-879/000-3102	1
	MicroSD Memory Card; pSLC NAND, 8 GB; temperature: -40 ... 85 °C	758-879/000-3108	1

## WAGO Sensor/Actuator Boxes

### General Product Information

#### For Signal Acquisition at the Machine Level

Passive M8/M12 sensor/actuator boxes are placed close to the process and acquire signals at the machine level. They can be used under very harsh environmental conditions and establish the connection between sensors/actuators and the controller via molded or detachable cables. Use of standardized pluggable connections supports plug-and-play installation of sensors and actuators, while trunk cables replace the individual wiring of I/O signals to automation components in the control cabinet. Cabling is well-organized and minimized.

#### The Benefit for You:

- Rugged, simple and compact extension for IP20 automation components
  - For stricter requirements on environmental conditions
  - For plug-and-play connector technology when needed
  - For simpler cable installation in the form of trunk cables
- High-quality PUR connection cables (drag chain compatible, halogen-free)
- Fully encapsulated (resistance and leak-proof)
- Flange sockets with a metal design
- Surrounding air temperature (operation): -25 ... +80 °C
- Status LEDs

#### Signal Acquisition in Exceptionally Harsh Conditions

WAGO's sensor/actuator boxes with molded cables have an extremely robust design and meet both IP67 and IP68 protection standards (72 hours at 1 m water depth). This design makes them ideal for applications where signals must be recorded in extreme environments (temperature, shock, vibration) without a control cabinet. They're also excellent alternatives when using an active IP67 I/O system would not be cost-effective due to a low signal count or the simple signal conditions (only digital signal acquisition/output).

#### Plug-&-Play Connection Technology

The IP67 sensor/actuator boxes with a removable connecting cable (M16 or M23 pluggable connector) are ideal for areas where frequent easy disconnection and reconnection are required (e.g., transport, modification, service).

#### Fixed Trunk Cable

The IP68 sensor/actuator boxes with molded cables are preferred when challenging cable paths do not allow preassembled M16/M23 cables.

#### Extreme Mechanical Performance

A system/machine is exposed to severe mechanical and thermal influences. It is important to process its signals despite severe vibrations and shocks. The sensor/actuator boxes are used at the machine level. Full encapsulation safeguards system operation, so even extreme vibration and temperature loads do not degrade signal acquisition and power supply via the connecting cable to the controller or other automation components located in the non-critical control cabinet area.

#### Flexible installation

The sensor/actuator boxes can be mounted directly on the machine. Extensive engineering ensures compliance with standardized specifications from CNOMO guidelines regarding the spacing of assembly drill holes that are often used in passive distribution boxes or sensor/actuator boxes. An optional adapter is available for seamlessly mounting two modules side by side. This has the advantage of maintaining a specified distance for properly routing the sensor/actuator cables and avoiding contamination points.







#### General Technical Data

Electrical Data	
Contact resistance, max.	10 mΩ
Supply voltage	10 ... 30 VDC
Current carrying capacity of the signal connections	2 A
Current carrying capacity of the supply connections	9 A (M12) or 6 A (M8)
Signal characteristics	PNP
Mechanical Data	
Protection class	
Sensor/actuator boxes with cable connection	IP68 (72 hours at 1 m water depth)
Sensor/actuator boxes with M16/M23 connection	IP67
Surrounding air temperature (operation)	-25 ... +80 °C
Mounting	Screw mount
Mounting position	Any
Vibration resistance	5g per IEC 60068-2-6
Shock resistance	49g per IEC 60068-2-27
Material Data	
Housing material	PA 66 (UL 94 V0); RAL 7035; silicon and halogen free
Encapsulation	Fully encapsulated with conformal coating (UL 94 V0)
Connecting Cable	Drag chain compatible



## WAGO Sensor/Actuator Boxes – Series 757

### Product Overview

Figure	Description	Item No.	Pack. Unit
<b>M12 Sensor/Actuator Boxes with Cable Connection</b>			
	M12 Sensor/Actuator Box; 4-way, 4-pole; 5 m connecting cable	757-244/000-005	1
	M12 Sensor/Actuator Box; 4-way, 4-pole; 10 m connecting cable	757-244/000-010	1
	M12 Sensor/Actuator Box; 6-way, 4-pole; 5 m connecting cable	757-264/000-005	1
	M12 Sensor/Actuator Box; 6-way, 4-pole; 10 m connecting cable	757-264/000-010	1
	M12 Sensor/Actuator Box; 8-way, 4-pole; 5 m connecting cable	757-284/000-005	1
	M12 Sensor/Actuator Box; 8-way, 4-pole; 10 m connecting cable	757-284/000-010	1
	M12 Sensor/Actuator Box; 8-way, 4-pole; 25 m connecting cable	757-284/000-025	1
	M12 Sensor/Actuator Box; 4-way, 5-pole; 5 m connecting cable	757-245/000-005	1
	M12 Sensor/Actuator Box; 4-way, 5-pole; 10 m connecting cable	757-245/000-010	1
	M12 Sensor/Actuator Box; 6-way, 5-pole; 5 m connecting cable	757-265/000-005	1
	M12 Sensor/Actuator Box; 6-way, 5-pole; 10 m connecting cable	757-265/000-010	1
	M12 Sensor/Actuator Box; 8-way, 5-pole; 5 m connecting cable	757-285/000-005	1
	M12 Sensor/Actuator Box; 8-way, 5-pole; 10 m connecting cable	757-285/000-010	1
M12 Sensor/Actuator Box; 8-way, 5-pole; 25 m connecting cable	757-285/000-025	1	
<b>M12 Sensor/Actuator Boxes, with M23 Connection</b>			
	M12 Sensor/Actuator Box; 4-port; 4-pole; M23 connector	757-144	1
	M12 Sensor/Actuator Box; 6-port; 4-pole; M23 connector	757-164	1
	M12 Sensor/Actuator Box; 8-port; 4-pole; M23 connector	757-184	1
	M12 Sensor/Actuator Box; 4-port; 5-pole; M23 connector	757-145	1
	M12 Sensor/Actuator Box; 6-port; 5-pole; M23 connector	757-165	1
	M12 Sensor/Actuator Box; 8-port; 5-pole; M23 connector	757-185	1
M12 Sensor/Actuator Box; 8-way; 5-pole; M23 connector; without LED	757-185/100-000	1	
<b>M8 Sensor/Actuator Boxes with Cable Connection</b>			
	M8 Sensor/Actuator Box; 4-way, 3-pole; 2 m connecting cable	757-443/000-002	1
	M8 Sensor/Actuator Box; 4-way, 3-pole; 5 m connecting cable	757-443/000-005	1
	M8 Sensor/Actuator Box; 4-way, 3-pole; 10 m connecting cable	757-443/000-010	1
	M8 Sensor/Actuator Box; 6-way, 3-pole; 5 m connecting cable	757-463/000-005	1
	M8 Sensor/Actuator Box; 6-way, 3-pole; 10 m connecting cable	757-463/000-010	1
	M8 Sensor/Actuator Box; 8-way, 3-pole; 5 m connecting cable	757-483/000-005	1
	M8 Sensor/Actuator Box; 8-way, 3-pole; 10 m connecting cable	757-483/000-010	1
	M8 Sensor/Actuator Box; 10-way, 3-pole; 5 m connecting cable	757-403/000-005	1
	M8 Sensor/Actuator Box; 10-way, 3-pole; 10 m connecting cable	757-403/000-010	1
<b>M8 Sensor/Actuator Boxes, with M16 Connection</b>			
	M8 Sensor/Actuator Box; 4-port; 3-pole; M16 connector	757-343	1
	M8 Sensor/Actuator Box; 6-port; 3-pole; M16 connector	757-363	1
	M8 Sensor/Actuator Box; 8-port; 3-pole; M16 connector	757-383	1
	M8 Sensor/Actuator Box; 10-port; 3-pole; M16 connector	757-303	1
<b>Accessories</b>			
	Marker Card; not stretchable; snap-on type; for M12 sensor/actuator box	757-011	1
	Marking strip; cut to specified length; not stretchable; plain; snap-on type; for M8 Sensor/Actuator Box		
	4-way	757-041	100
	6-way	757-061	100
	8-way	757-081	100
	10-way	757-001	100
	Felt-Tip Pen; for permanent marking	210-110	1
	Protective Cap; for covering unused sensor/actuator ports		
	M8 Protective Cap	756-8101	10
	M12 Protective Cap	756-8102	10
	Spacer Module; for sensor/actuator box		
	4-way	757-040	10
	6-way	757-060	10
	8-way	757-080	10
	10-way	757-000	10

## WAGO Industrial Switches

### General Product Information



#### Always the Right Solution

WAGO's range of switches ensures the scalability of your ETHERNET network infrastructure, while providing outstanding electrical and mechanical performance. These robust switches are designed for industrial use and are fully compliant with IEEE 802.3, IEEE 802.3u and IEEE 802.3ab.

#### Combinable with Fiber Optic Cables

ETHERNET via fiber optic cables offers a large number of advantages for industrial applications.

High immunity to interference, electrical isolation and long ranges up to 80 km are extremely beneficial characteristics – and these benefits are a perfect fit with the IT environment.

#### Scaled Selection

Unmanaged and managed switches in various designs are available for high-end applications. Our Eco Switches are ideal for cost-sensitive applications that do not require technical features such as redundancy. They are ideal for small- to medium-sized networks.

#### The Benefit for You:

- Adaptable to different transmission media
- Automatically adapts to
  - Speed (auto-negotiation)
  - Wiring (auto-crossover, MDI/MDIX)
- Optional redundancy
- Wide supply voltage range

#### Modular and Expandable

Exchangeable SPF modules adapt WAGO's switches to various fiber optic cables (FOC) and the associated required distances and fibers.

SFP modules are available for multimode and single-mode fiber optic cables for ranges up to 80 km. With the ideal combination of copper and fiber optic cables, you are prepared for a large number of requirements.

#### Web-Based Management

WAGO's fully managed switches have integrated Web-based management. Any Web browser can be used to configure the switch.

#### Integrated Function Monitoring

For monitoring and error reporting, the managed switch has configurable functions such as an email alarm and SNMP traps. In addition, all switches (except for Eco versions) can monitor individual ports or the power supply via a potential-free alarm contact. A DIP switch configures this function.

#### Full Bandwidth on All Ports

The switches' internal bandwidth is designed so that all ports can communicate simultaneously – in full duplex without restrictions.

#### Security

Managed switches have built-in security features, such as:

- Authentication
- Access control lists
- DHCP snooping
- Port security

#### Data Transfer

Managed switches provide configuration options for data transfer, such as:

- VLAN
- IGMP snooping
- IP-based VLAN
- MAC-based VLAN

#### Availability of Redundancy

Select industrial switches have several options for building redundant network structures and guarantee secure communication – even when connections are faulty:

- Rapid Spanning Tree per IEEE 802.1w – compatible with the IT standard
- Jet Ring – a simple ring protocol with switching time < 300 ms
- Xpress Ring – a fast ring protocol with switching time < 20 ms
- ERPSv2 per ITU-T standard, switching time < 50 ms
- Media Redundancy Protocol (MRP), switching time < 200 ms

In addition to communication link redundancy, a redundant power supply, which can also be monitored using an alarm relay, is integrated into the switches. If the power supply fails, communication is not interrupted.

#### Different Operating Modes

The unmanaged switches are ideal for direct plug-and-play use. Managed switches are available for applications where IP filtering or further interpretation of telegrams is required for the application.

#### Configurable Performance

Managed switches offer performance control features, such as:

- Storm control
- Bandwidth control
- Auto-provisioning
- Link aggregation

#### Configuration and Diagnostics

Modbus® can be used to diagnose managed switches. Configuration and diagnostics can also be performed with standardized protocols such as SNMP.

Selected products also have the "PROFINET Conformance Class B" certificate. This allows simple diagnostics and configuration in PROFINET systems.

#### General Technical Data

Packet throughput per port	10 Mbps port: 14,880 packages per second (pps) 100 Mbps port: 148,800 packages per second (pps) 1000 Mbps port: 1,488,000 packages per second (pps)
Surrounding air temperature (operation)	-40 ... +70 °C (for differences, see data sheet)
Surrounding air temperature (storage)	-40 ... +80 °C (for differences, see data sheet)
Relative humidity, max.	95 % without condensation (for differences, see data sheet)
Vibration resistance	IEC 60068-2-6
Shock resistance	IEC 60068-2-27
EMC immunity to interference	EN 61000-6-2
EMC emission of interference	EN 61000-6-4
Protection class	IP30
Mounting type	DIN-35 rail mounting

# WAGO Industrial Switches General Product Information

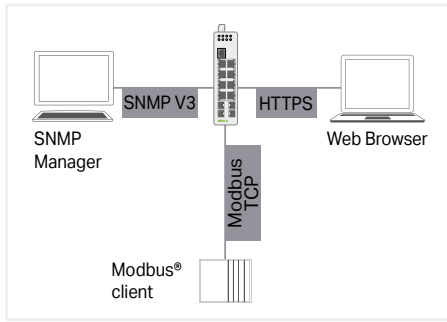

Configuration and Diagnostics  
Several Options

- Configuration via Web-Based Management
- Configuration via command line (SSH, Telnet, RS-232)
- Network management via SNMP v1, v2c, v3
- Support of MIB standards (Management Information Base)
- PROFINET configuration with the device description file (GDSML)
- Comprehensive data available for easy diagnostics via Modbus®

Informations SFP	
Câble fibre	Link Lip
Connecteur	LC
Longueur d'onde(nm)	853
Distance de transmission	550m(50m OM2) MIB mode
DMB support(oui/non)	Y1.5 (Memory Calibration)
Nom du fabricant(nom)	WAGO
Adresse du fabricant(nom)	862-1200
Versión du fabricant(nom)	V2.0
Numero de série du fabricant (nom)	Ax1633002658
Code date(nom)	160509

Informations DDM(nom)					
	Courant(nom)	Alarme haute (nom)	Alarme basse (nom)	Avert. haut (nom)	Avert. bas(nom)
	(mA)	(mA)	(mA)	(mA)	(mA)
Température(C)	36.148	80.000	-45.000	65.000	-40.000
Tension(V)	3.290	3.500	3.000	3.500	3.100
Tx Rise(mA)	0.754	25.000	1.000	20.000	2.000
Tx Power(mW)	0.218	0.501	0.000	0.300	0.112
Rx Power(mW)	-4.735	-3.000	-6.506	-4.001	-5.206
Rx Power(dBm)	0.262	0.631	0.016	0.021	0.020
Rx Power(dBm)	-5.986	-2.004	-10.016	-3.000	-17.012

DDM: Digital Diagnostic Monitoring

- Automatic detection of a connected SFP module
- Detailed module information
- Monitoring in real time
  - Temperature
  - Supply voltage
  - Transmission power
  - Received power

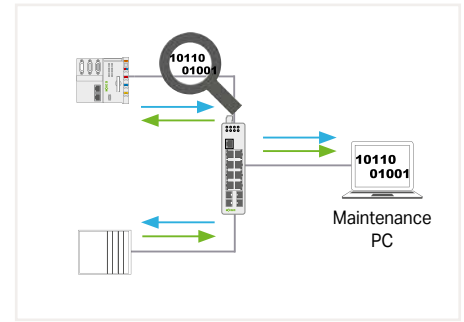

Monitoring and Diagnostics  
Simplified Maintenance

- Port mirroring
- Mirroring the network traffic
- LLDP
- Automatically detects adjacent devices
- Email notifications

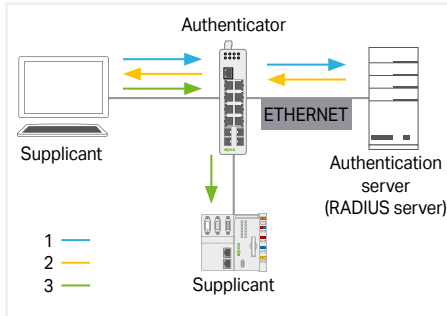

IEEE 802.1X Authentication  
The Security Standard for IT Networks

Secure authentication and authorization in ETHERNET networks (locally on the switch or via RADIUS server)

Process:

- Authentication of a subscriber is performed by the authenticator.
- The authenticator checks the authentication information of the subscriber (supplicant) with an authentication server.

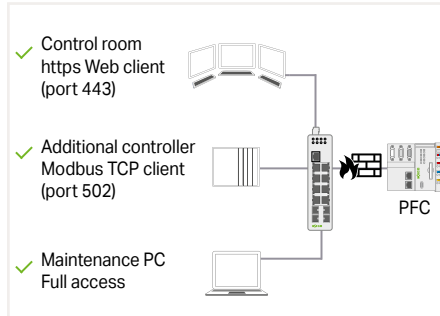

Firewall – Access Control List  
Authorization Only for the Required Services

Filtering data packets on the basis of:

- Source MAC or source IP address
- Destination MAC or destination IP address
- Range of MAC or IP addresses
- UDP/TCP source or destination ports

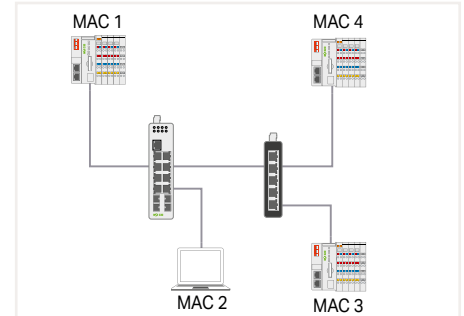

Port Security

- Dynamically learns MAC addresses for each port
- Limitation of MAC addresses for each port
- MAC-based white/blacklist for each port

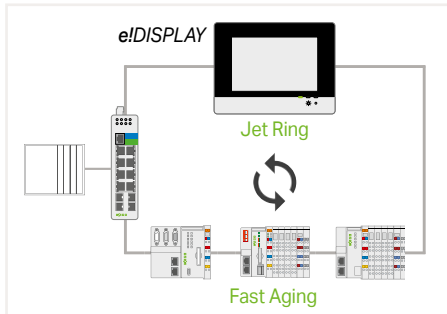

Jet Ring

- Typical switching time < ~ 300 ms (depends on the application)
- Extremely easy configuration
- Up to 20 participants (fast aging) in a Jet Ring

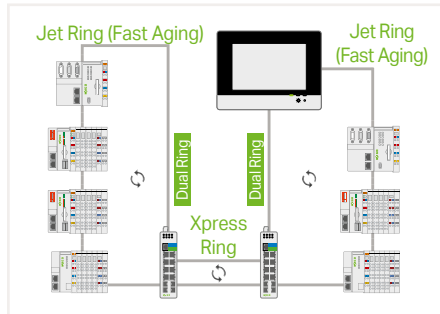

Xpress Ring

- Switching time < 20 ms
- Easy configuration
- Up to 200 switches in one Xpress Ring
- Two Xpress Rings per switch

Dual Ring

- Combination of both redundancy types
- 1 Jet Ring and 1 Xpress Ring per switch or 2 Xpress Rings per switch

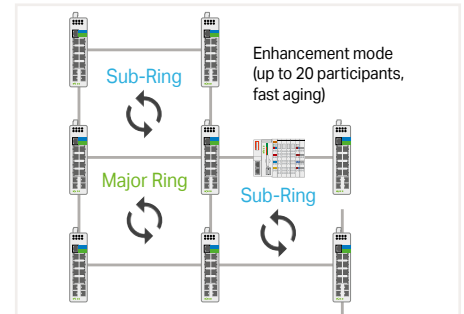

ERPS: ETHERNET Ring Protection Switching

- Standardized and open technology
- Switching time < 50 ms
- Nested topologies with up to 6 rings per switch
- Implementation of one-fault tolerance (SPOF – Single Point of Failure)

ERPS – Enhancement Mode

- WAGO devices with an integrated switch and fast aging configuration
- Typical switching time < ~ 300 ms (depends on the application)

# WAGO Industrial Switches – 852 Series

## Product Overview

Figure	Number of Copper Ports			Number of Fiber Optic Ports		Managed	Lean Managed	PROFINET CC-B	IEC 61850-3	MAC Security	Description	Item No.
	100BASE-TX	1000BASE-T	PoE+	100BASE-FX	1000BASE-SX/LX							
<b>Industrial switches</b>												
	5										5 100BASE-TX ports	852-101
	8										8 100BASE-TX ports	852-102
	8			2							8 100BASE-TX ports; 2 100BASE-FX slots	852-103
	8										8 1000BASE-T ports	852-1102
	16										16 1000BASE-T ports	852-1106
<b>Industrial Managed Switches</b>												
	8					x					8 100BASE-TX ports; 2 1000BASE-SX/LX slots	852-303
	8					x		x			8 100BASE-TX ports; PROFINET CC-B	852-602
	8			2		x		x			8 100BASE-TX ports; 2 1000BASE-SX/LX slots; PROFINET CC-B	852-603
	8			4		x					8 1000BASE-T ports; 4 1000BASE-SX/LX slots	852-1305
	8			4		x			x		8 1000BASE-T ports; 4 1000BASE-SX/LX slots; USB	852-1305/000-001
	8					x			x		8 1000BASE-T ports	852-1322
	6			2		x			x		6 1000BASE-T ports; 2 1000BASE-SX/LX slots	852-1328
	8	8		4		x					8 1000BASE-T ports; 4 1000BASE-SX/LX slots; 8 * Power over Ethernet	852-1505
	8	8		4		x			x		8 1000BASE-T ports; 4 1000BASE-SX/LX slots; 8 * Power over Ethernet; USB	852-1505/000-001
8			4		x			x		8 1000BASE-T ports; 4 1000BASE-SX/LX slots; PROFINET CC-B	852-1605	
<b>Lean Managed Switches</b>												
	8						x				8 1000BASE-T ports	852-1812
	8			2			x				8 1000BASE-T ports; 2 1000BASE-SX/LX slots	852-1813
	8						x				8 1000BASE-T ports; 2 1000BASE-SX/LX slots; 8 * Power over Ethernet	852-1813/000-001
	16	8		2			x				16 1000BASE-T ports	852-1816
<b>Industrial Eco Switches</b>												
	5										5 100BASE-TX ports	852-111
	5										5 1000BASE-T ports	852-1111
	8										8 1000BASE-T ports	852-1112
	5	4									5 1000BASE-T ports; extended temperature; 4 * Power over Ethernet	852-1411
	5	4									5 1000BASE-T ports; extended temperature; 4 * Power over Ethernet	852-1411/000-001
5	4		2							5 1000BASE-T ports; 2 1000BASE-SX/LX slots; 4 * Power over Ethernet	852-1417	
<b>Industrial Eco Switches</b>												
	8										8 100BASE-TX ports	852-112
<b>Accessories</b>												
Figure	Description											Item No.
	SFP Modules; 100BASE; FX multimode 1310 nm LC; 2 km											852-201/107-002
	SFP Modules; 100BASE; FX single-mode 1310 nm LC; 30 km											852-201/107-030
	SFP Modules; 1000BASE; extended temperature; DDM; SX multi-mode 850 nm LC; 0.55 km											852-1200
	SFP Modules; 1000BASE; extended temperature; DDM; LX single-mode 1310 nm LC; 10 km											852-1210
	SFP Modules; 1000BASE; extended temperature; DDM; ZX single-mode 1550 nm LC; 80 km											852-1280
	DNV Mounting Adapter; for 852-111/852-1111 Industrial Switches; marine approval											852-9101



Insertion during operation



Mechanical locking



Adapts to the fiber type



# WAGO Industrial Switches – 852 Series

## Product Overview

		Unmanaged										Managed																
		Eco					Standard					Full					PROFINET			Lean								
		852-111	852-112	852-1111	852-1112	852-1411	852-1411/000-001	852-1417	852-101	852-102	852-103	852-1102	852-1106	852-303	852-1305	852-1305/000-001	852-1322	852-1328	852-1505	852-1505/000-001	852-602	852-603	852-1605	852-1812	852-1813	852-1813/000-001	852-1816	
Hardware	Number of copper ports	5	8	5	8	5	5	5	5	8	8	8	16	8	8	8	8	6	8	8	8	8	8	8	8	8	8	16
	100 Mbit/s	■	■	■	■	■	■	■	■	■	■	■	■	■	■	■	■	■	■	■	■	■	■	■	■	■	■	
	1 Gbit/s			■	■	■	■	■				■	■			■	■	■	■	■			■	■	■	■	■	
	PoE+ ports among these (1 Gbit/s)	0	0	0	0	4	4	4	0	0	0	0	0	0	0	0	0	0	8	8	0	0	0	0	0	0	8	0
	Number of SFP ports	0	0	0	0	0	0	2	0	0	2	0	0	2	4	4	0	2	4	4	0	2	4	0	2	2	0	
	100 Mbit/s										■			■			■	■				■			■	■		
	1 Gbit/s							■						■	■	■	■	■	■	■		■	■		■	■		
Alarm relays	0	0	0	0	0	0	0	1	1	1	1	1	1	1	1	1	1	1	1	1	1	1	1	1	1	1	1	
Approvals, Standards, Certificates	CE	■	■	■	■	■	■	■	■	■	■	■	■	■	■	■	■	■	■	■	■	■	■	■	■	■	■	
	DNV GL	■		■										■	■													
	UL 61010	■	■	■	■	■	■	■	■	■	■	■	■	■	■	■	■	■	■	■	■	■	■	■	■	■	■	
	IEC 61850-3															■				■								
	PROFINET CC-B																				■	■	■					
Hardware Features	Status LEDs				■	■	■	■	■	■	■	■	■	■	■	■	■	■	■	■	■	■	■	■	■	■	■	
	Autonegotiation	■	■	■	■	■	■	■	■	■	■	■	■	■	■	■	■	■	■	■	■	■	■	■	■	■	■	
	Auto-crossing	■	■	■	■	■	■	■	■	■	■	■	■	■	■	■	■	■	■	■	■	■	■	■	■	■	■	
	PROFINET CC-A			■	■	■	■	■				■	■	■	■	■	■	■	■	■	■	■	■	■	■	■	■	
Configuration	DIP switch (diagnostics)							■	■	■	■	■	■	■	■	■	■	■	■	■	■	■	■	■	■	■	■	
	Web-Based Management (http, https)													■	■	■	■	■	■	■	■	■	■	■	■	■	■	
	SNMP (MIB)													■	■	■	■	■	■	■	■	■	■	■	■	■	■	
	CLI (SSH, Telnet)													■	■	■			■	■	■	■	■	■	■	■	■	
	PROFINET Configurator (GSDML file)																				■	■	■					
	USB storage															■				■								
Diagnostics	Status LED (LINK active)	■	■	■	■	■	■	■	■	■	■	■	■	■	■	■	■	■	■	■	■	■	■	■	■	■	■	
	Status LED (LINK down)							■	■	■	■			■	■		■	■	■	■	■	■	■	■	■	■	■	
	Status LED (alarm)							■	■	■	■	■		■	■	■	■	■	■	■	■	■	■	■	■	■	■	
	SNMP (MIB)													■	■	■	■	■	■	■	■	■	■	■	■	■	■	
	SNMP traps													■	■	■	■	■	■	■	■	■	■	■	■	■	■	
	Modbus® registers													■	■	■	■	■	■	■				■	■	■	■	
	Web-Based Management (http, https)													■	■	■	■	■	■	■	■	■	■	■	■	■	■	
	PROFINET diagnostics																				■	■	■					
	Neighborhood detection (LLDP)													■	■	■			■	■	■	■	■					
Topology map																							■	■	■	■		
Dashboard																							■	■	■	■		
Redundancy	Redundant power supply							■	■	■	■	■	■	■	■	■	■	■	■	■	■	■	■	■	■	■	■	
	Jet Ring													■	■	■			■	■								
	Xpress Ring													■	■	■			■	■								
	ETHERNET Ring Protection Switching													■	■	■			■	■				■	■	■	■	
	Media Redundancy Protocol (MRP) (client/manager)																				■	■	■					
	RSTP/STP													■	■	■	■	■	■	■	■	■	■	■	■	■	■	
Network Security	Segmentation (VLAN)													■	■	■	■	■	■	■	■	■	■	■	■	■	■	
	Authentication (IEEE 802.1X)													■	■	■	■	■	■	■	■	■	■	■	■	■	■	
	Access Control List (MAC, IP)													■	■	■			■	■	■	■	■	■	■	■	■	
	Port security													■	■	■			■	■				■	■	■	■	
	MAC security (IEEE 802.1AE)																■	■										
Data Transmission and Performance	LACP link aggregation													■	■	■			■	■								
	Prioritization (IEEE 802.1 p)			■	■	■	■	■					■	■	■	■	■	■	■	■	■	■	■	■	■	■	■	
	Quality of service (IEEE 802.1 Q)													■	■	■	■	■	■	■	■	■	■	■	■	■	■	
	Bandwidth limitation													■	■	■			■	■	■	■	■	■	■	■	■	
	Storm detection													■	■	■			■	■	■	■	■	■	■	■	■	
	Routing within VLANs													■	■	■			■	■	■	■	■	■	■	■	■	

\* Under development

# WAGO Shield Connection System

## Description and Installation

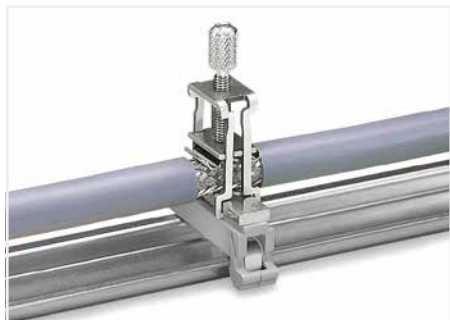

Carrier with grounding foot\* (790-113), 45 mm long, busbar 90° to the DIN-rail

\* For all shield clamping saddle sizes



Carrier with grounding foot\* (790-114), 45 mm long, busbar parallel to the DIN-rail

\* For all shield clamping saddle sizes



Carrier with grounding foot\* (790-115), 125 mm long, busbar parallel to the DIN-rail

\* For all shield clamping saddle sizes



Mounting a clamping saddle on a specialty slotted DIN-rail (790-145)  
When releasing the saddle, do not place your finger under the clamping spring!



Removing the shield clamping saddle



Shield clamping saddle contacts shield conductor and specialty slotted DIN-rail (790-145). Please use the spacer module (790-144) under the rail.



Horizontal mounting position of the busbar (790-134) via T-connector (790-398)



Vertical mounting position of the busbar

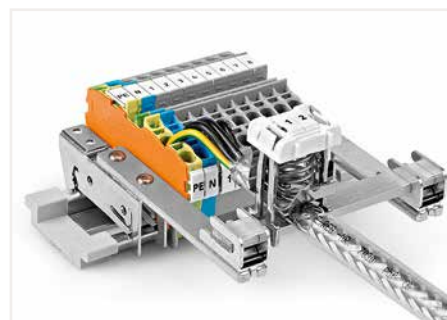

Example Application



❶ Carrier with grounding foot, parallel to the DIN-rail







❷ Insulated mounting carriers (790-100) for a common shield reference potential, independent of housing potential



❸ Shield clamping saddle (790-190) on 10 mm x 3 mm copper U-shaped busbar, produced for the specific application

6

## WAGO Shield Connection System – 790 Series

Figure	Description	Item No.	Pack. Unit
<b>Shield Clamping Saddle</b>			
	11 mm wide; contactable shield diameter; 3 ... 8 mm	790-108	50
	19 mm wide; contactable shield diameter; 7 ... 16 mm	790-116	50
	27 mm wide; contactable shield diameter; 6 ... 24 mm	790-124	50
	43 mm wide; contactable shield diameter; 22 ... 40 mm	790-140	50
<b>Spring-Equipped Shield Clamping Saddles</b>			
	12.4 mm wide; contactable shield diameter; 3 ... 8 mm	790-208	50
	21.8 mm wide; contactable shield diameter; 6 ... 16 mm	790-216	25
	30 mm wide; contactable shield diameter; 6 ... 20 mm	790-220	25
<b>Busbar Carrier; for 10 mm x 3 mm copper busbars</b>			
	One-sided; straight; distance between center of DIN-rail and busbar carrier: 70 mm	790-300	10
	One-sided; straight; distance between center of DIN-rail and busbar carrier: 80 mm	790-302	10
	One-sided; angled; distance between center of DIN-rail and busbar carrier: 70 mm	790-301	10
	Double-sided; straight; distance between center of DIN-rail and busbar carrier: 70 mm	790-310	10
	Double-sided; straight; distance between center of DIN-rail and busbar carrier: 80 mm	790-312	10
	Double-sided; angled; distance between center of DIN-rail and busbar carrier: 70 mm	790-311	10
	With T-connector; flexible; distance between center of DIN-rail and busbar carrier: 70 mm; height: 56 mm	790-350/790-398	12
	With T-connector; flexible; distance between center of DIN-rail and busbar carrier: 70 mm; height: 99 mm	790-352/790-398	12
	With T-connector; flexible; distance between center of DIN-rail and busbar carrier: 85 mm; height: 56 mm	790-360/790-398	12
	With T-connector; flexible; distance between center of DIN-rail and busbar carrier: 85 mm; height: 99 mm	790-362/790-398	12
<b>Accessories</b>			
Description	Item No.	Pack. Unit	6
Carrier with Grounding Foot; parallel to the DIN-rail; 15 mm long; copper, 10 x 3 mm, ①	790-110	25	
Carrier with Grounding Foot; parallel to the DIN-rail; 25 mm long; copper, 10 x 3 mm	790-112	25	
Carrier with Grounding Foot; parallel to the DIN-rail; 45 mm long; copper, 10 x 3 mm	790-114	25	
Carrier with Two Grounding Feet; parallel to the DIN-rail; 125 mm long; copper, 10 mm x 3 mm	790-115	25	
Carrier with Grounding Foot; 90° from the DIN-rail; 45 mm long; copper, 10 mm x 3 mm	790-113	25	
DIN-Rail; specialty slotted; 1000 mm long; tin-plated	790-145	1	
Spacer Sleeve; steel; for DIN-rail; specialty slotted; for M5-size screw	790-144	200	
Insulated Mounting Foot; for busbar with M4 x 8 mm screw ②	790-100	50	
Insulated Mounting Foot; for busbar with (3.5 x 9) mm sheet metal screw	790-101	50	
Busbar; tin-plated; 30 mm long; copper, 10 mm x 3 mm	790-133	20	
Busbar; tin-plated; 50 mm long; copper, 10 mm x 3 mm	790-134	20	
Busbar; tin-plated; 1000 mm long; copper, 10 mm x 3 mm	210-133	1	
U-Shaped Busbar; copper, 10 mm x 3 mm; for 5 I/Os; tall version; for 750 Series I/O Modules ③	790-190	25	
U-Shaped Busbar; copper, 10 mm x 3 mm; for 8 I/Os; tall version; for 750 Series I/O Modules	790-191	25	
U-Shaped Busbar; copper, 10 mm x 3 mm; for 5 I/Os; short version; for 750 Series I/O Modules	790-192	25	
U-Shaped Busbar; copper, 10 mm x 3 mm; for 8 I/Os; short version; for 750 Series I/O Modules	790-193	25	
Shield Termination; includes cable ties for 5 ... 10 mm shield diameter; 60 mm long	790-350	100	
Shield Termination; includes cable ties for 5 ... 10 mm shield diameter; 150 mm long	790-352	100	
T-Connector; connects two 10 mm x 3 mm copper busbars	790-398	10	



Fit the shield termination (790-350) to the shield conductor.



Secure both shield conductor and shield termination (790-350) to the strain relief plate using cable ties.

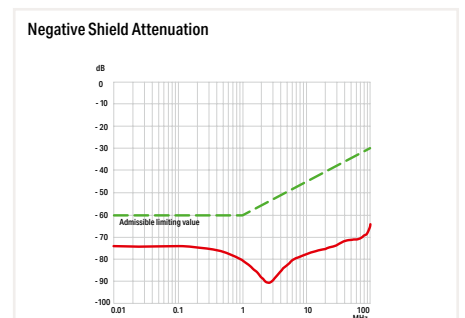

The shield connection system is highly effective because the clamping unit can be brought very close to the unshielded part of the cable.

## Advanced Power Supply System from WAGO

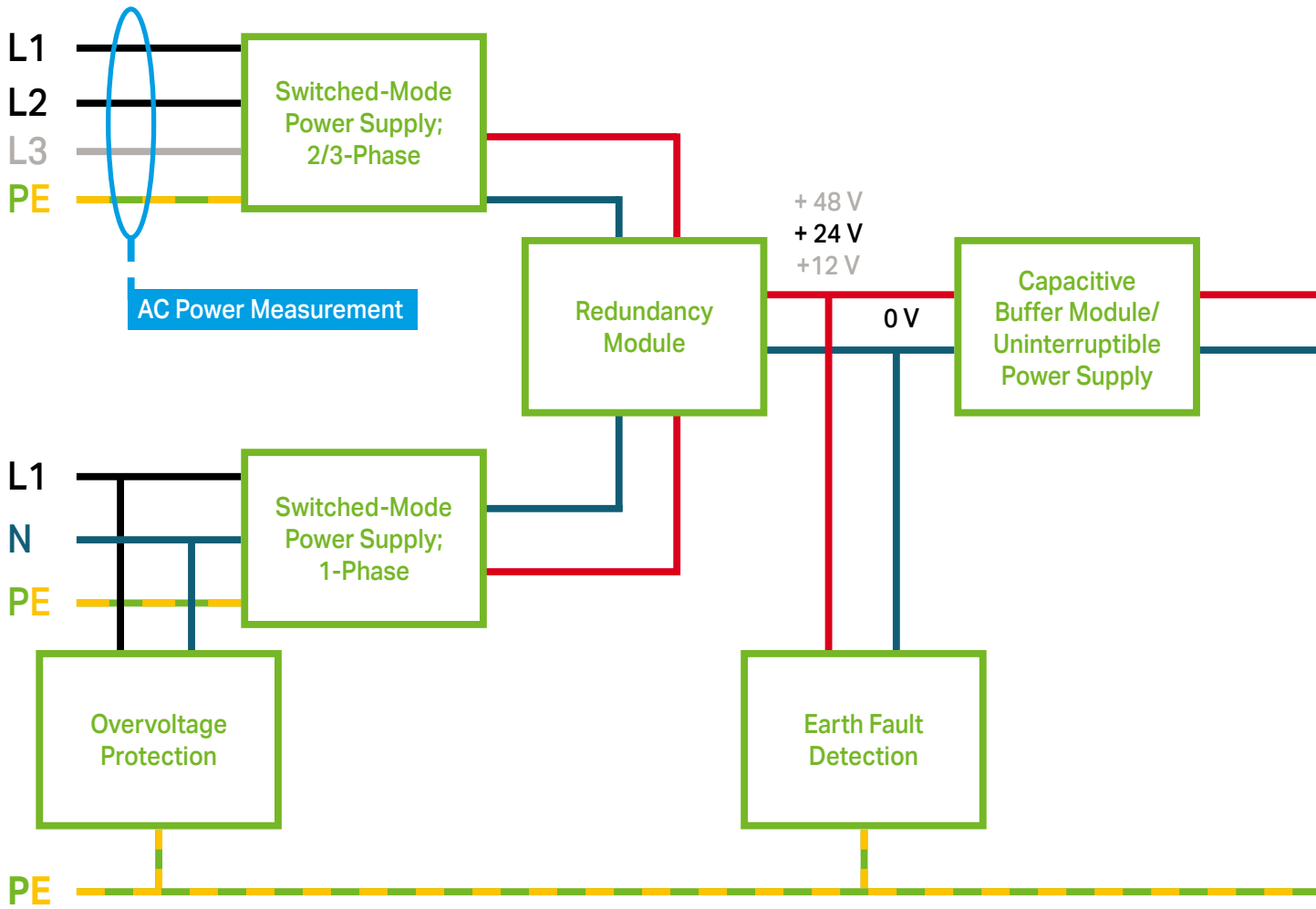

7



PRO 2

### PRO 2

Single- and three-phase power supplies with a wide input voltage range, 12 V, 24 V or 48 V nominal output, PowerBoost, TopBoost and optional communication module



CLASSIC

### CLASSIC

Single-phase power supplies with a wide input voltage range and 12 V, 24 V or 48 V nominal output



ECO

### ECO

Single- and three-phase power supplies with a wide input voltage range and 24 V nominal output



COMPACT

### COMPACT

Low-profile, single-phase power supplies with a wide input voltage range and nominal output voltages of 5 V, 12 V, 18 V and 24 V

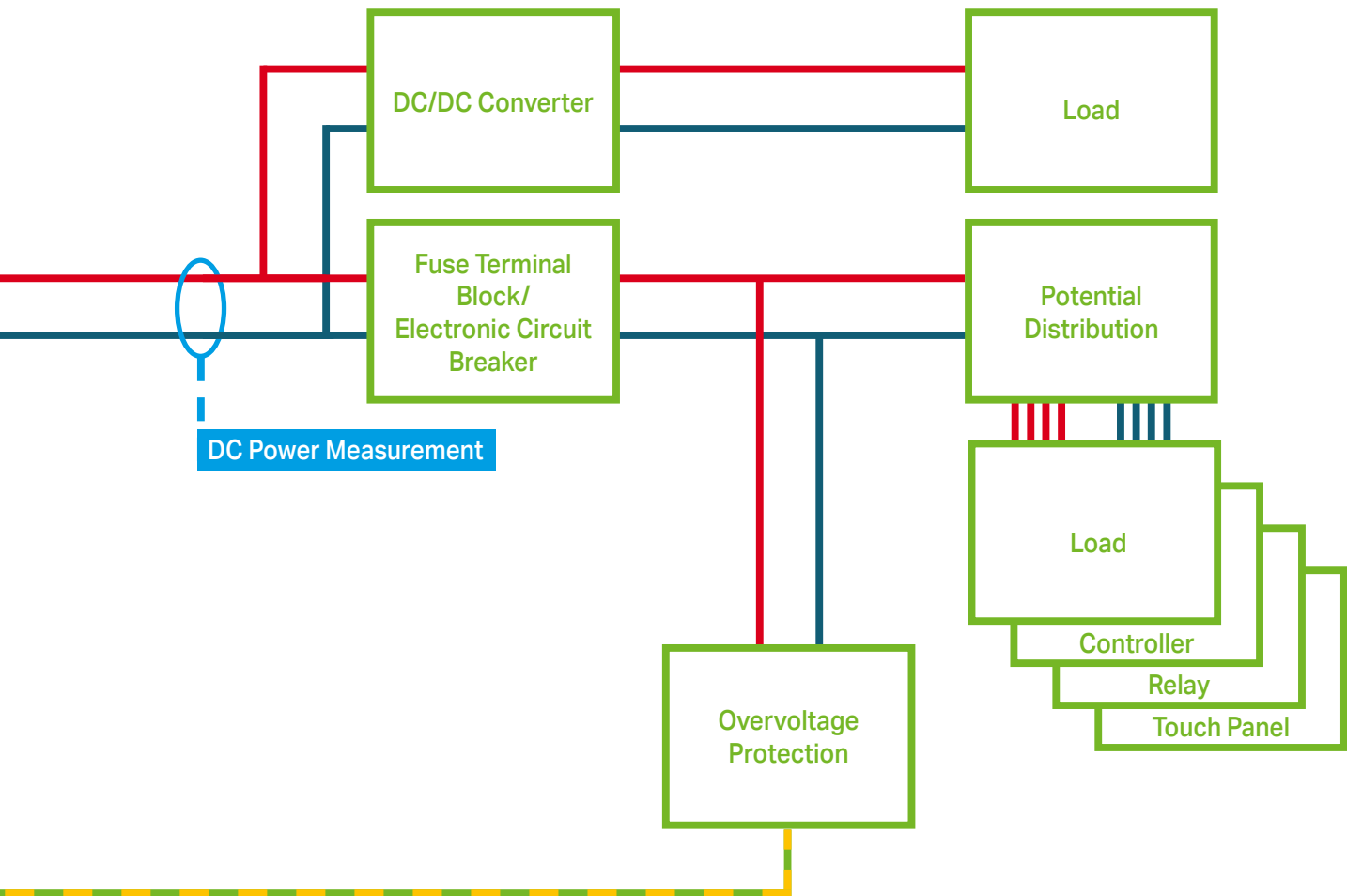

Electronic Circuit Breakers

**ELECTRONIC CIRCUIT BREAKERS**

Configurable 2-, 4- or 8-channel ECBs feature integrated current and voltage monitoring



UPS

**UNINTERRUPTIBLE POWER SUPPLIES (UPS)**

The UPS charger/controller and connected battery modules reliably compensate for longer power failures and feature integrated battery control technology



Capacitive Buffer Modules

**CAPACITIVE BUFFER MODULES**

Maintenance-free, capacitive buffer modules ensure seamless operation during short voltage fluctuations





Redundancy Modules

**REDUNDANCY MODULES**

Redundancy modules safeguard two power supplies connected in parallel, providing system redundancy or additional power

# WAGO Pro 2 Power Supplies – 2787 / 2789 Series

Illustration	Nominal Input Voltage	Output Current	Efficiency	Derating (> +55 °C and U <sub>e</sub> < 230 VAC)	PowerBoost	MTBF (per IEC 61709)	Dimensions (W x H x D in mm)	Item No.
<b>1-phase; TopBoost + PowerBoost; DI/DO; communication interface; output voltage: 12 VDC</b>								
	100 ... 240 VAC	10 A	≥ 93.8 %	-3 %/K	15 ADC (5 s)	> 1,200,000 h	35 x 130 x 130	2787-2134
	100 ... 240 VAC	15 A	≥ 95.3 %	-3 %/K	22.5 ADC (5 s)	> 1,200,000 h	70 x 130 x 130	2787-2135
<b>1-phase; TopBoost + PowerBoost; DI/DO; communication interface; output voltage: 24 VDC</b>								
	100 ... 240 VAC	5 A	≥ 93.8 %	-3 %/K	7.5 ADC (5 s)	> 1,200,000 h	35 x 130 x 130	2787-2144
	100 ... 240 VAC	10 A	≥ 95.3 %	-3 %/K	15 ADC (5 s)	> 1,200,000 h	50 x 130 x 130	2787-2146
	100 ... 240 VAC	20 A	≥ 95.4 %	-3 %/K	30 ADC (5 s)	> 900,000 h	70 x 130 x 130	2787-2147
	200 ... 240 VAC	40 A	≥ 96.1 %	-3 %/K	60 ADC (5 s)	> 900,000 h	120 x 130 x 130	2787-2448
<b>1-phase; TopBoost + PowerBoost; DI/DO; communication interface; output voltage: 48 VDC</b>								
	100 ... 240 VAC	5 A	≥ 95.3 %	-3 %/K	7.5 ADC (5 s)	> 900,000 h	50 x 130 x 130	2787-2157
	100 ... 240 VAC	10 A	≥ 95.3 %	-3 %/K	15 ADC (5 s)	> 800,000 h	70 x 130 x 130	2787-2157
<b>3-phase; TopBoost + PowerBoost; DI/DO; communication interface; output voltage: 24 VDC</b>								
	(2 / 3) x 400 ... 500 VAC	10 A	≥ 93 %	-3 %/K	15 ADC (5 s)	> 1,200,000 h	50 x 130 x 130	2787-2346
	(2 / 3) x 400 ... 500 VAC	20 A	≥ 95.9 %	-3 %/K	30 ADC (5 s)	> 900,000 h	70 x 130 x 130	2787-2347
	(2 / 3) x 400 ... 500 VAC	40 A	≥ 96.3 %	-3 %/K	60 ADC (5 s)	> 800,000 h	120 x 130 x 130	2787-2348
<b>1-phase; TopBoost + PowerBoost; DI/DO; communication interface; output voltage: 48 VDC</b>								
	(2 / 3) x 400 ... 500 VAC	10 A	≥ 95 %	-3 %/K	15 ADC (5 s)	> 900,000 h	70 x 130 x 130	2787-2357
	(2 / 3) x 400 ... 500 VAC	20 A	≥ 96 %	-3 %/K	30 ADC (5 s)	> 800,000 h	120 x 130 x 130	2787-2358

Accessories								
Illustration	Description							Item No.
	IO-Link Communication Module							2789-9080
	Modbus RTU Communication Module							2789-9015
	Ethernet/Modbus® TCP/Modbus® UDP/MQTT Communication Module							2789-9052
	Configuration Cable; USB connection; see page 209							

7



**WAGO Pro 2 Power Supplies**  
This new generation of professional power supplies is for applications requiring high performance, efficiency and reliability. These devices also offer tremendous added value thanks to flexible configuration and comprehensive monitoring via optional communication interface – can be used with the WAGO USB Communication Cable and IO-Link Communication Module.



**Communication**  
The pluggable IO-Link communication modules allow continuous fieldbus communication, provide data (such as the current output current and voltage), and can also be configured or put in standby mode remotely.



**Configuration**  
WAGO's new Interface Configuration software offers both local/remote configuration and parameter setting, allowing the power supplies to be quickly and easily tailored to the system requirements. The configuration function can be used to parameterize the power supply as an ECB.

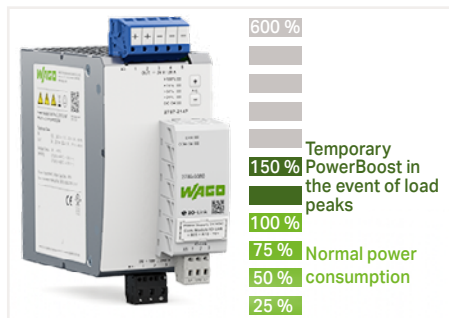

**Load management**  
Rapidly switching capacitive loads and high start-up currents are no problem, thanks to 150 % output power (PowerBoost) for five seconds. Output current up to 600 % for 15 ms provides reserves for rapidly and reliably tripping miniature circuit breakers. The option of allowing a specified output current to be exceeded for a configurable amount of time allows the Pro 2 Power Supply to work like a single-channel ECB.









**Efficiency**  
Up to 96 % efficiency within a wide load range is the key to energy cost savings, reduced power losses and lower demand for control cabinet cooling. The CO<sub>2</sub> footprint is also dramatically reduced. WAGO's Pro 2 Power Supply can be permanently connected to the PLC via the communication module or a digital signal, enabling switch off of the power supply output via a signal and use of the standby mode for saving energy.



**Robust Design**  
WAGO's Pro 2 Power Supplies can be started and operated from -40 °C to +70 °C, allowing significant cost savings by reducing the need for control cabinet air conditioning. Featuring low derating capability above 60 °C, the Pro 2 units deliver nearly full output power at 70 °C. Furthermore, their highly robust design provides reliable operation in high-vibration and shock-prone applications. The power supplies can be operated at altitudes up to 5000 m, requiring no derating below 2000 m ASL.

## WAGO Pro Power Supplies – 787 Series

Illustration	Nominal Input Voltage	Output Current	Efficiency	Derating	PowerBoost	MTBF (per IEC 61709)	Dimensions (W x H x D in mm)	Item No.
<b>1-phase; TopBoost + PowerBoost; DC OK contact; output voltage: 12 VDC</b>								
	100 ... 240 VAC	6 A	≥ 83 %	-3 %/K (> +50 °C)	12 ADC (4 s); 9 ADC (8 s)	> 500,000 h	40 x 163 x 163	<b>787-819</b>
	100 ... 240 VAC	10 A	≥ 87.8 %	-3 %/K (> +50 °C)	20 ADC (4 s); 15 ADC (8 s)	> 500,000 h	57 x 163 x 163	<b>787-821</b>
	100 ... 240 VAC	15 A	≥ 87 %	-3 %/K (> +50 °C)	30 ADC (4 s); 22.5 ADC (8 s)	> 500,000 h	57 x 163 x 179	<b>787-831</b>
<b>1-phase; TopBoost + PowerBoost; DC OK contact; output voltage: 24 VDC</b>								
	100 ... 240 VAC	3 A	≥ 87.8 %	-3 %/K (> +50 °C)	6 ADC (4 s); 4.5 ADC (8 s)	> 500,000 h	40 x 163 x 163	<b>787-818</b>
	100 ... 240 VAC	5 A	≥ 87.8 %	-3 %/K (> +50 °C)	10 ADC (4 s); 7.5 ADC (8 s)	> 500,000 h	57 x 163 x 163	<b>787-822</b>
	100 ... 240 VAC	10 A	≥ 90 %	-3 %/K (> +50 °C)	20 ADC (4 s); 15 ADC (8 s)	> 500,000 h	57 x 163 x 179	<b>787-832</b>
	100 ... 240 VAC	20 A	≥ 91 %	-3 %/K (> +50 °C)	30 ADC (4 s); 55 ADC (8 s)	> 500,000 h	97 x 171 x 187	<b>787-834</b>
<b>1-phase; TopBoost + PowerBoost; DC OK contact; output voltage: 48 VDC</b>								
	100 ... 240 VAC	5 A	≥ 91 %	-3 %/K (> +50 °C)	10 ADC (4 s); 7.5 ADC (8 s)	> 500,000 h	57 x 163 x 179	<b>787-833</b>
	100 ... 240 VAC	10 A	≥ 91 %	-3 %/K (> +50 °C)	17.5 ADC (4 s); 15 ADC (8 s)	> 500,000 h	97 x 171 x 187	<b>787-835</b>
<b>3-phase; TopBoost + PowerBoost; DC OK contact; output voltage: 24 VDC</b>								
	(2 / 3) x 400 ... 500 VAC	10 A	≥ 91.7 %	-3 %/K (> +50 °C)	20 ADC (4 s); 15 ADC (16 s)	> 500,000 h	57 x 163 x 179	<b>787-840</b>
	(2 / 3) x 400 ... 500 VAC	20 A	≥ 92.9 %	-3 %/K (> +50 °C)	40 ADC (4 s); 30 ADC (16 s)	> 500,000 h	77 x 171 x 179	<b>787-842</b>
	(2 / 3) x 400 ... 500 VAC	40 A	≥ 93.6 %	-5 %/K (> +45 °C)	60 ADC (4 s); 50 ADC (16 s)	> 500,000 h	128 x 171 x 205	<b>787-844</b>
<b>3-phase; TopBoost + PowerBoost; DC OK contact; output voltage: 24 VDC; LineMonitor</b>								
	(2 / 3) x 400 ... 500 VAC	10 A	≥ 91.7 %	-3 %/K (> +50 °C)	20 ADC (4 s); 15 ADC (16 s)	> 500,000 h	57 x 163 x 179	<b>787-850</b>
	(2 / 3) x 400 ... 500 VAC	20 A	≥ 92.9 %	-3 %/K (> +50 °C)	40 ADC (4 s); 30 ADC (16 s)	> 500,000 h	77 x 171 x 179	<b>787-852</b>
	(2 / 3) x 400 ... 500 VAC	40 A	≥ 93.6 %	-5 %/K (> +45 °C)	60 ADC (4 s); 50 ADC (16 s)	> 500,000 h	128 x 171 x 205	<b>787-854</b>
<b>3-phase; TopBoost + PowerBoost; DC OK contact; output voltage: 48 VDC</b>								
	(2 / 3) x 400 ... 500 VAC	10 A	≥ 93 %	-3 %/K (> +50 °C)	15 ADC (4 s); 12.5 ADC (16 s)	> 500,000 h	77 x 171 x 179	<b>787-845</b>
	(2 / 3) x 400 ... 500 VAC	20 A	≥ 94.4 %	-3 %/K (> +50 °C)	30 ADC (4 s); 25 ADC (16 s)	> 500,000 h	128 x 171 x 205	<b>787-847</b>



### TopBoost

- Provides many times the nominal current for up to 50 ms
- Fast and reliable triggering of the secondary-side fusing via miniature circuit breakers or melting fuses in the event of a short circuit or overload

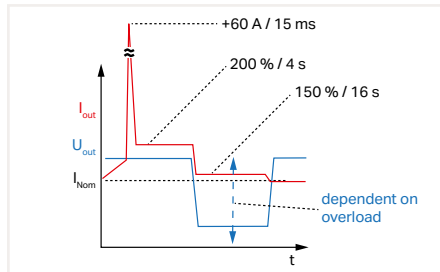

### PowerBoost

- Provides 200 % of output power for four seconds
- Provides 150 % of output power for up to 16 seconds
- Ideal during start-up or switching of capacitive loads, valve clusters, motors etc.
- Power reserve eliminates expensive oversizing

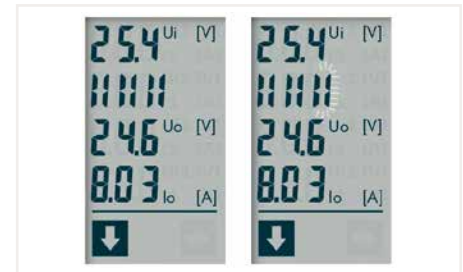

### Innovative Communication

- LineMonitor with display and function keys
- Variable monitoring, e.g., current, voltage, phase position, operating hours and more
- Output voltage and overload behavior can be parameterized
- Integrated fault memory



### RS-232 Serial Interface

- Front-side integrated interface communicates with a PC or PLC
- Free 759-850 Configuration Software and 759-851 Visualization Software can be downloaded at [www.wago.com](http://www.wago.com)
- Free function blocks are available for various PLC systems
- 787-890 Serial Communication Cable is available as an accessory

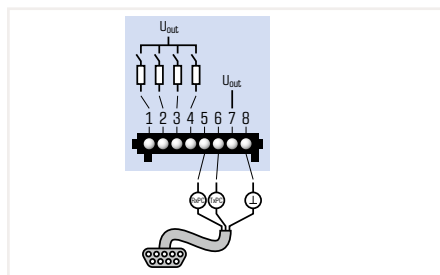

### Active Signal Contacts

- Four active signal outputs for watchdog functions
- Each unit features a separate collective message for warning/fault
- Features two individually configurable signal outputs
- Free configuration software (order no.: 759-850) at [www.wago.com](http://www.wago.com)

# WAGO Classic Power Supplies – 787 Series

Illustration	Nominal Input Voltage	Output Current	Efficiency	Signal	Features	MTBF (per IEC 61709)	Dimensions (W x H x D in mm)	Item No.
<b>2-phase; output voltage: 12 VDC</b>								
	100 ... 240 VAC	2 A	≥ 82 %	DC OK signal	NEC class 2	> 500,000 h	22.5 x 90 x 107.5	787-1601
	100 ... 240 VAC	4 A	≥ 86 %	DC OK signal	NEC class 2	> 500,000 h	45 x 90 x 107.5	787-1611
	100 ... 240 VAC	7 A	≥ 86 %	DC OK signal		> 500,000 h	52 x 90 x 119	787-1621
	100 ... 240 VAC	15 A	≥ 90 %	DC OK contact	TopBoost	> 500,000 h	55 x 27 x 172	787-1631
<b>1-phase; output voltage: 24 VDC</b>								
	100 ... 240 VAC	1 A	≥ 86 %	DC OK signal	NEC class 2	> 500,000 h	22.5 x 90 x 107.5	787-1602
	100 ... 240 VAC	2 A	≥ 89 %	DC OK signal	NEC class 2	> 500,000 h	45 x 90 x 107.5	787-1606
	100 ... 240 VAC	4 A	≥ 89 %	DC OK signal		> 500,000 h	52 x 90 x 119.5	787-1616
	100 ... 240 VAC	3.8 A	≥ 87 %	DC OK signal	NEC class 2	> 500,000 h	52 x 90 x 119	787-1616/000-1000
	100 ... 240 VAC	5 A	≥ 89 %	DC OK contact	TopBoost	> 500,000 h	42 x 127 x 137.5	787-1622
	100 ... 240 VAC	10 A	≥ 91 %	DC OK contact	TopBoost	> 500,000 h	55 x 127 x 172	787-1632
	100 ... 240 VAC	20 A	≥ 92 %	DC OK contact	TopBoost	> 500,000 h	95 x 127 x 170	787-1634
<b>1-phase; output voltage: 48 VDC</b>								
	100 ... 240 VAC	2 A	≥ 86 %	DC OK contact		> 500,000 h	52 x 90 x 119	787-1623
	100 ... 240 VAC	5 A	≥ 92 %	DC OK contact	TopBoost	> 500,000 h	55 x 127 x 172	787-1633
	100 ... 240 VAC	10 A	≥ 93 %	DC OK contact	TopBoost	> 500,000 h	95 x 127 x 170	787-1635
<b>1-phase/2-phase; output voltage: 24 VDC</b>								
	(1 / 2) x 200 ... 500 VAC	5 A	≥ 89 %	DC OK contact	TopBoost	> 500,000 h	42 x 127 x 143.5	787-1628
	(1 / 2) x 200 ... 500 VAC	10 A	≥ 92.5 %	DC OK contact	TopBoost	> 500,000 h	55 x 127 x 146.5	787-1638
<b>3-phase; output voltage: 24 VDC</b>								
	(2 / 3) x 400 ... 500 VAC	10 A	≥ 90 %	DC OK contact	TopBoost	> 500,000 h	55 x 127 x 171	787-1640
	(2 / 3) x 400 ... 500 VAC	20 A	≥ 92 %	DC OK contact	TopBoost	> 500,000 h	80 x 127 x 180	787-1642
	(2 / 3) x 400 ... 500 VAC	40 A	≥ 92 %	DC OK contact	TopBoost	> 500,000 h	126 x 127 x 198	787-1644

7



### Communicative

- Green LED indicates output voltage availability
- Remote monitoring via DC OK signal or potential-free DC OK contact
- Easy commissioning and maintenance
- Quickly provide system information or machine status



### Integrated TopBoost\*

- Multiplies the nominal current
- Fast and reliable triggering of the secondary-side fusing via circuit breakers or melting fuses in the event of a short circuit and overload

\* Only for 787-1622 ... -1628, -1631 ... -1638, -1640 ... -1644



### Device Marking

- Marking field for fast and securely attached device identification
- Supports WAGO's WMB Multi Marking System (5 mm pin spacing)
- Supports WAGO Marking Strips, 11 mm wide

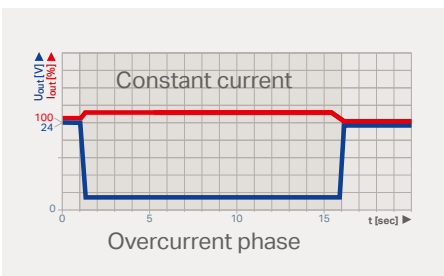

### High Load-Carrying Capacity

- Constant current characteristic under overload conditions
- 110 % of output current with a lowered output voltage – even during a short circuit
- High capacitive loads can be reliably started

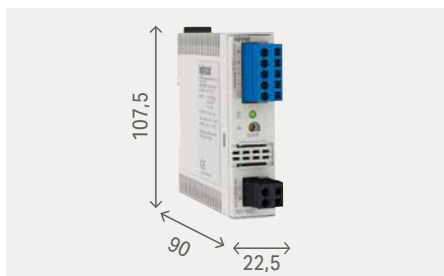





### Slim Design

- Enclosure width has been reduced by up to 45 % compared to previous Classic Power Supplies
- Saves valuable cabinet space



# WAGO Eco 2 Power Supplies – 2687 Series / Eco – 787 Series

Illustration	Nominal Input Voltage	Output Current	Efficiency	Derating	Signal	MTBF (per IEC 61709)	Dimensions (W x H x D in mm)	Item No.
<b>1-phase; output voltage: 24 VDC; Eco 2</b>								
	100 ... 240 VAC	1.25 A	≥ 88 %	-3 %/K (> +50 °C)		> 600,000 h	25 x 90 x 100	2687-2142
	100 ... 240 VAC	5 A	≥ 89 %	-3 %/K (> +50 °C)	DC OK contact	> 600,000 h	38 x 130 x 130	2687-2144
<b>1-phase; output voltage: 12 VDC; several mounting options</b>								
	100 ... 240 VAC	2 A	≥ 86 %	-4 %/K (> +45 °C)		> 300,000 h	30 x 90 x 99	787-1701
	100 ... 240 VAC	4 A	≥ 86 %	-4 %/K (> +45 °C)		> 300,000 h	40 x 90 x 99	787-1711
	100 ... 240 VAC	8 A	≥ 86 %	-3 %/K (> +40 °C)		> 300,000 h	60 x 130 x 99	787-1721
<b>1-phase; output voltage: 24 VDC</b>								
	110 ... 240 VAC	2.5 A	≥ 86 %	-3.3 %/K (> 50 °C)		480,000 h	50 x 92 x 136	787-712
	110 ... 240 VAC	5 A	≥ 86 %	-5.3 %/K (> 45 °C)		480,000 h	75 x 92 x 136	787-722
	110 ... 240 VAC	10 A	≥ 86 %	-2.3 %/K (> 40 °C)		480,000 h	110 x 92 x 136	787-732
	110 ... 240 VAC	20 A	≥ 90 %	-2.7 %/K (> 55 °C)	DC OK signal	> 250,000 h	115 x 136 x 144	787-734
	110 ... 240 VAC	40 A	≥ 90 %	-2.7 %/K (> 55 °C)	DC OK signal	> 250,000 h	170 x 136 x 150	787-736
<b>1-phase; output voltage: 24 VDC; several mounting options</b>								
	100 ... 240 VAC	1.25 A	≥ 87 %	-4 %/K (> +45 °C)		> 300,000 h	30 x 90 x 99	787-1702
	100 ... 240 VAC	2.5 A	≥ 88 %	-4 %/K (> +45 °C)		> 300,000 h	40 x 90 x 99	787-1712
	100 ... 240 VAC	5 A	≥ 88 %	-3 %/K (> +45 °C)		> 300,000 h	60 x 130 x 99	787-1722
	100 ... 240 VAC	10 A	≥ 91 %	-4 %/K (> +45 °C)		> 300,000 h	70 x 165 x 99	787-1732
<b>3-phase; output voltage: 24 VDC</b>								
	(2 / 3) x 400 ... 500 VAC	6.25 A	≥ 87 %	-2.5 %/K (> 50 °C)	DC OK contact	> 250,000 h	50 x 130 x 92	787-738
	(2 / 3) x 400 ... 500 VAC	10 A	≥ 89 %	-1.3 %/K (> 50 °C)	DC OK contact	> 250,000 h	65 x 130 x 130	787-740
	(2 / 3) x 400 ... 480 VAC	20 A	≥ 90.5 %	-2 %/K (> 45 °C)	DC OK contact	> 1,800,000 h	80 x 130 x 170	787-2742
	(2 / 3) x 400 ... 480 VAC	40 A	≥ 91.5 %	-2 %/K (> 45 °C)	DC OK contact	> 1,300,000 h	140 x 130 x 170	787-2744

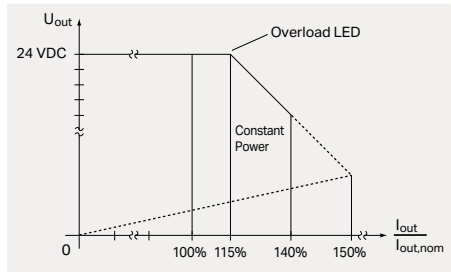

### High Load-Carrying Capacity

- Overload warning from 1.15 times the nominal output current\*
- Overload of up to 1.4 times the nominal current with a lowered output voltage (constant power)\*
- Output shutdown in case of a low-resistance short circuit; also includes automatic restart

\* Except for 787-17xx

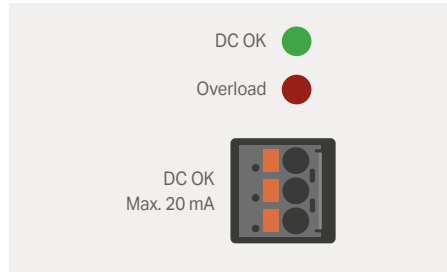

### Status Monitoring

- Potential-isolated make contact signal, via bounce-free optocoupler\* or PhotoMOS\*\*
- Indicates whether an output voltage or an overload is present
- Ideal for remote monitoring

\* Only for 787-734 ... -740

\*\* Only for 787-2742, -2744

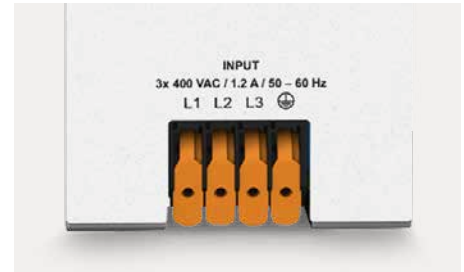

### Fast Wiring

- Convenient, tool-free wiring thanks to lever-actuated terminal strips\*
- Integrated test slot simplifies testing by eliminating conductor removal

\* Only for 787-734 ... -740, -2742, -2744



### Various Mounting Options

- Flexible mounting via DIN-rail adapter\*
- Flexible installation via screw-mount clips\*

\* Only for 787-17xx



### Highly Economical







- Triple the savings thanks to low purchase costs, easy installation and maintenance-free operation
- Budget-friendly for basic applications



### EN 60335-1 Household Appliances Standard

- Power supplies with item numbers with the 787-17xx format meet the requirements of the household appliances standard

# WAGO Compact Power Supplies – 787 Series

Illustration	Nominal Input Voltage	Output Current	Efficiency	Signal	MTBF (per IEC 61709)	Special Mounting Features	Dimensions (W x H x D in mm)	Item No.
<b>1-phase; output voltage: 5 VDC</b>								
	100 ... 240 VAC	5.5 A	≥ 75 %		> 500,000 h	Overhead mounting	72 x 89 x 55	<b>787-1020</b>
<b>2-phase; output voltage: 12 VDC</b>								
	100 ... 240 VAC	2 A	≥ 80 %		> 500,000 h	Overhead mounting	54 x 89 x 55	<b>787-1001</b>
	100 ... 240 VAC	4 A	≥ 85 %		> 500,000 h	Overhead mounting	72 x 89 x 55	<b>787-1011</b>
	100 ... 240 VAC	6 A	≥ 87 %		> 500,000 h	Overhead mounting	90 x 89 x 55	<b>787-1021</b>
<b>1-phase; output voltage: 12 VDC; with <i>picoMAX</i> connection technology (tool-free)</b>								
	100 ... 240 VAC	2.5 A	≥ 88 %		> 500,000 h	Removable front panel	54 x 90 x 52.5	<b>787-1201</b>
	100 ... 240 VAC	5 A	≥ 88.5 %		> 500,000 h	Removable front panel	72 x 90 x 52.5	<b>787-1211</b>
	100 ... 240 VAC	8 A	≥ 91.5 %		> 500,000 h		108 x 90 x 52.5	<b>787-1221</b>
<b>1-phase; output voltage: 18 VDC</b>								
	100 ... 240 VAC	2.4 A	≥ 84 %		> 500,000 h	Overhead mounting	72 x 89 x 55	<b>787-1017</b>
<b>1-phase; output voltage: 24 VDC</b>								
	100 ... 240 VAC	1.3 A	82 %		> 500,000 h	Overhead mounting	54 x 89 x 55	<b>787-1002</b>
	100 ... 240 VAC	2.5 A	88 %		> 500,000 h	Overhead mounting	72 x 89 x 55	<b>787-1012</b>
	100 ... 240 VAC	4 A	88 %		> 500,000 h	Overhead mounting	90 x 89 x 55	<b>787-1022</b>
<b>1-phase; output voltage: 24 VDC; with <i>picoMAX</i> connection technology (tool-free)</b>								
	100 ... 240 VAC	0.5 A	83 %		> 700,000 h		18 x 90 x 52.5	<b>787-1200</b>
	110 ... 240 VAC	1.25 A	88 %		> 500,000 h		36 x 90 x 55	<b>787-2850</b>
	100 ... 240 VAC	1.3 A	82 %	DC OK signal	> 500,000 h		54 x 89 x 55	<b>787-1102</b>
	100 ... 240 VAC	1.3 A	87 %	DC OK signal	> 700,000 h	Removable front panel	54 x 90 x 52.5	<b>787-1202</b>
	100 ... 240 VAC	2.5 A	88 %	DC OK signal	> 500,000 h		72 x 89 x 55	<b>787-1112</b>
	100 ... 240 VAC	2.5 A	89 %	DC OK signal	> 500,000 h	Removable front panel	72 x 90 x 52.5	<b>787-1212</b>
	100 ... 240 VAC	4 A	88 %	DC OK signal	> 500,000 h		90 x 89 x 55	<b>787-1122</b>
	100 ... 240 VAC	4.2 A	90 %	DC OK signal	> 500,000 h	Removable front panel	108 x 90 x 52.5	<b>787-1216</b>
	100 ... 240 VAC	6 A	90 %	DC OK signal	> 500,000 h	Removable front panel	144 x 90 x 52.5	<b>787-1226</b>

7

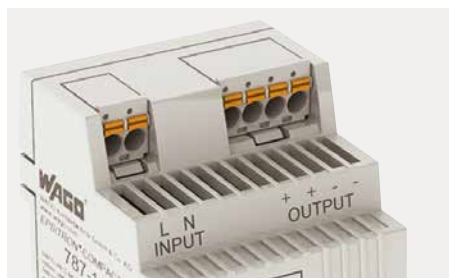

### Easy to Connect

- Vibration-proof, fast and maintenance-free CAGE CLAMP® connections
- Pre-assembly possible via pluggable *picoMAX*® connection technology\*

\* Only for 787-11xx, 787-12xx



### Overhead Mounting

- Any type of mounting position is possible at reduced output power
- Units can even be mounted overhead, e.g., in ceiling-mounted distribution boxes



### DIN-Rail Built-In Format

- Housing design per EN 43880, for installation in small distribution boards or meter panels



### Highly Economical

- Triple the savings thanks to low purchase costs, easy installation and maintenance-free operation
- Budget-friendly for basic applications



### Various Mounting Options

- Easy mounting on DIN-rail
- Flexible installation via screw-mount clips also possible\*

\* Only for 787-12xx



### EN 60335-1 Household Appliances Standard

- Power supplies with item numbers with the 787-12xx format meet the requirements of the household appliances standard

# WAGO DC/DC Converter – 787 / 288 Series

Illustration	Nominal Input Voltage	Nominal Output Voltage	Input Current	Output Current	Efficiency	Dimensions (W x H x D in mm)	Item No.
<b>DC OK contact; in a compact 6 mm housing</b>							
	24 VDC	5 VDC	≤ 0.34 A	0.5 A	≥ 82.5 %	6 x 97.8 x 94	<b>787-2801</b>
	24 VDC	10 VDC	≤ 0.42 A	0.5 A	≥ 89 %	6 x 97.8 x 94	<b>787-2802</b>
	24 VDC	12 VDC	≤ 0.5 A	0.5 A	≥ 90 %	6 x 97.8 x 94	<b>787-2805</b>
	48 VDC	24 VDC	≤ 0.34 A	0.5 A	≥ 91 %	6 x 97.8 x 94	<b>787-2803</b>
	24 VDC	5/10/12 VDC	≤ 0.5 A	0.5 A	≥ 82.5 %	6 x 97.8 x 94	<b>787-2810</b>
<b>Output voltage: 12 VDC</b>							
	24 VDC	12 VDC	≤ 3.39 A	4 A	≥ 84 %	45 x 90 x 107.5	<b>787-1650</b>
	72 VDC	12 VDC	≤ 0.79 A	4 A	≥ 85 %	72 x 89 x 55	<b>787-1015/072-000</b>
<b>Output voltage: 18 VDC</b>							
	24 VDC	18 VDC	≤ 0.37 A	0.4 A	82 %	50 x 25 x 85	<b>288-895</b>
<b>Output voltage: 24 VDC</b>							
	72 VDC	24 VDC	≤ 0.79 A	2 A	≥ 84 %	72 x 89 x 55	<b>787-1014/072-000</b>
	110 VDC	24 VDC	≤ 0.77 A	2 A	≥ 85 %	72 x 89 x 55	<b>787-1014</b>

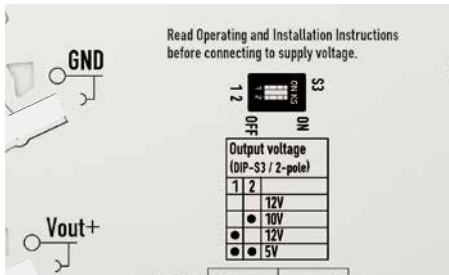

- One device for many applications**
- Output voltage of the DC/DC Converter (787-2810) set via built-in DIP switch

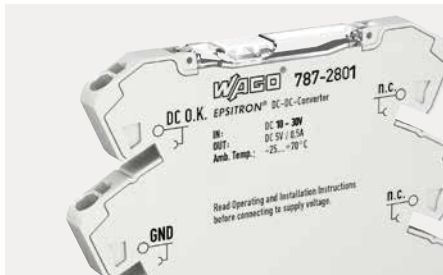

- Communicative**
- Green LED indicates output voltage availability
  - Remote monitoring via DC OK signal
  - Easy commissioning and maintenance

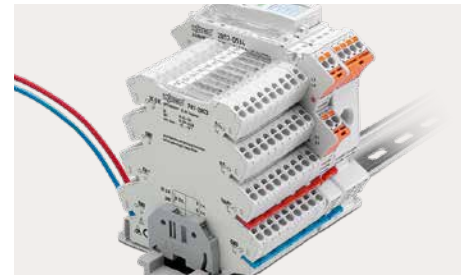

- Can Be Commoned with 857/2857 Series**
- Full commoning of the supply voltage thanks to shared profile between the 787-28xx DC/DC Converters and the 857/2857 Series Relays and Signal Conditioners



- The Industry's Most Compact**
- "True" 6.0 mm (0.23 inch) width maximizes panel space



- Suitable for Railway Applications per EN 50155**
- Wide DC input voltage range
  - Wide temperature range
  - Protective coating

\* Only 787-1014 & 787-101x/0072-0000

# WAGO Electronic Circuit Breakers – 787 Series

Illustration	Output Current	Signaling	Features	Dimensions (W x H x D in mm)	Item No.
<b>1 channel; input voltage: 24 VDC</b>					
	1 x 0.5 A (fixed setting)	1 status LED (green/yellow/red/blue)	Communication capability	6 x 97.8 x 94	787-2861/050-000
	1 x 1 A (fixed setting)	1 status LED (green/yellow/red/blue)	Communication capability	6 x 97.8 x 94	787-2861/100-000
	1 x 2 A (fixed setting)	1 status LED (green/yellow/red/blue)	Communication capability	6 x 97.8 x 94	787-2861/200-000
	1 x 4 A (fixed setting)	1 status LED (green/yellow/red/blue)	Communication capability	6 x 97.8 x 94	787-2861/400-000
	1 x 6 A (fixed setting)	1 status LED (green/yellow/red/blue)	Communication capability	6 x 97.8 x 94	787-2861/600-000
	1 x 8 A (fixed setting)	1 status LED (green/yellow/red/blue)	Communication capability	6 x 97.8 x 94	787-2861/800-000
	1 x 1/2/3/4/5/6/8 A	1 status LED (green/yellow/red/blue)	Communication capability	6 x 97.8 x 94	787-2861/108-020
<b>2 channels; input voltage: 24 VDC</b>					
	2 x 0.5/1/2/3/4/6 A	2 LED statuses (green/red/orange)	Active current limitation; communication capability	45 x 90 x 115.5	787-1662/006-1000
	2 x 3.8 A	2 LED statuses (green/red/orange)	Active current limitation; NEC class 2; communication capability	45 x 90 x 115.5	787-1662/004-1000
	2 x 2/3/4/6/8/10 A	2 LED statuses (green/red/orange)	Communication capability	45 x 90 x 115.5	787-1662
	2 x 1/2/3/4/5/6 A	2 LED statuses (green/red/orange)	Communication capability	45 x 90 x 115.5	787-1662/106-000
	2 x 2/3/4/6/8/10 A	2 LED statuses (green/red/orange)	Signal contact; special configuration	45 x 90 x 115.5	787-1662/000-054
<b>2 channels; input voltage: 48 VDC</b>					
	2 x 2/3/4/6/8/10 A	2 LED statuses (green/red/orange)	Signal contact	45 x 90 x 115.5	787-1662/000-250
<b>4 channels; input voltage: 12 VDC</b>					
	4 x 2/3/4/6/8/10 A	4 LED statuses (green/red/orange)	Communication capability	45 x 90 x 115.5	787-1664/000-100
<b>4 channels; input voltage: 24 VDC</b>					
	4 x 0.5/1/2/3/4/6 A	4 LED statuses (green/red/orange)	Active current limitation; communication capability	45 x 90 x 115.5	787-1664/006-1000
	4 x 3.8 A	4 LED statuses (green/red/orange)	Active current limitation; NEC class 2; communication capability	45 x 90 x 115.5	787-1664/004-1000
	4 x 2/4/6/8/10/12 A	4 LED statuses (green/red/orange)	Active current limitation; communication capability	45 x 90 x 115.5	787-1664/212-1000
	4 x 0.5/1/2/3/4/6 A	4 LED statuses (green/red/orange)	Active current limitation; signal contact; special configuration	45 x 90 x 115.5	787-1664/006-1054
	4 x 1/2/3/4/6/8/10 A	4 LED statuses (green/red/orange)	IO-Link	45 x 90 x 115.5	787-1664/000-080
	4 x 2/3/4/6/8/10 A	4 LED statuses (green/red/orange)	Communication capability	45 x 90 x 115.5	787-1664
	4 x 1/2/3/4/5/6 A	4 LED statuses (green/red/orange)	Communication capability	45 x 90 x 115.5	787-1664/106-000
	4 x 1/2/3/4/5/6 A	4 LED statuses (green/red/orange)	Communication capability; NPN signaling	45 x 90 x 115.5	787-1664/106-011
	4 x 2/3/4/6/8/10 A	4 LED statuses (green/red/orange)	Communication capability; special configuration	45 x 90 x 115.5	787-1664/000-004
	4 x 2/3/4/6/8/10 A	4 LED statuses (green/red/orange)	Signal contact; special configuration	45 x 90 x 115.5	787-1664/000-054
	4 x 2/3/4/6/8/10 A	4 LED statuses (green/red/orange)	Communication capability; NPN signaling	45 x 90 x 115.5	787-1664/000-011
<b>4 channels; input voltage: 48 VDC</b>					
	4 x 2/3/4/6/8/10 A	4 LED statuses (green/red/orange)	Communication capability	45 x 90 x 115.5	787-1664/000-200
	4 x 2/3/4/6/8/10 A	4 LED statuses (green/red/orange)	Signal contact	45 x 90 x 115.5	787-1664/000-250
<b>8 channels; input voltage: 24 VDC</b>					
	8 x 0.5/1/2/3/4/6 A	8 LED statuses (green/red/orange)	Active current limitation; communication capability	42 x 127 x 142.5	787-1668/006-1000
	8 x 0.5/1/2/3/4/6 A	8 LED statuses (green/red/orange)	Active current limitation; signal contact; special configuration	42 x 127 x 142.5	787-1668/006-1054
	8 x 1/2/3/4/5/6 A	8 LED statuses (green/red/orange)	Communication capability	42 x 127 x 142.5	787-1668/106-000
	8 x 2/3/4/6/8/10 A	8 LED statuses (green/red/orange)	Communication capability	42 x 127 x 142.5	787-1668
	8 x 2/3/4/6/8/10 A	8 LED statuses (green/red/orange)	Communication capability; special configuration	42 x 127 x 142.5	787-1668/000-004
	8 x 2/3/4/6/8/10 A	8 LED statuses (green/red/orange)	Signal contact; special configuration	42 x 127 x 142.5	787-1668/000-054
	8 x 1/2/3/4/5/6 A	8 LED statuses (green/red/orange)	Signal contact	42 x 127 x 142.5	787-1668/106-054
	8 x 1/2/3/4/6/8/10 A	8 LED statuses (green/red/orange)	IO-Link	42 x 127 x 142.5	787-1668/000-080
<b>8 channels; input voltage: 48 VDC</b>					
	8 x 2/3/4/6/8/10 A	8 LED statuses (green/red/orange)	Communication capability	42 x 127 x 142.5	787-1668/000-200
	8 x 2/3/4/6/8/10 A	8 LED statuses (green/red/orange)	Signal contact	42 x 127 x 142.5	787-1668/000-250

7

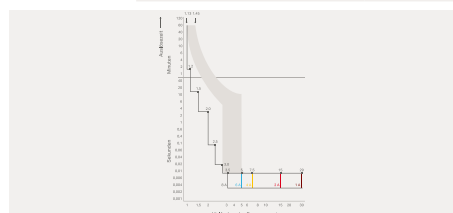

### Trip Characteristics

- Reliable and precise disconnection in case of overcurrent or short circuit
- Nominal currents can be set separately for each channel
- No voltage drop on other current paths thanks to optional active short circuit limitation to 1.5 times the nominal current



### Intuitive Operation

- Each output channel has backlit buttons for switching on/off, as well as status acknowledgement
- Integrated, multi-color LEDs indicate the operating status of each channel
- Transparent cover can be sealed and marked
- Nominal current can be individually adjusted for each channel
- The setting is visible even when no voltage is applied



### Communication

- Remote digital input S1 resets all tripped channels
- Digital output S3 transmits a simple group message indicating whether one of the channels was tripped by an overcurrent
- Optional isolated signal contact as a group signal (instead of S2 and S3 digital outputs), IO-Link or Manchester protocol

# Uninterruptible Power Supply (UPS); Battery Module; Capacitive Buffer Module; Redundancy Module – 787 Series

Illustration	Nominal Input Voltage	Output Current	Efficiency	Buffer Time	Features	Dimensions (W x H x D in mm)	Item No.
--------------	-----------------------	----------------	------------	-------------	----------	------------------------------	----------

**Power Supply with Integrated Charger and Controller; 1-phase; output voltage: 24 VDC**

	100 ... 240 VAC	5 A	≥ 88 %	1 s ... 20 min	Communication capability; charging current ≤ 1 A	60 x 127 x 135.5	787-1675
---	-----------------	-----	--------	----------------	--	------------------	----------

**UPS Charger and Controller; output voltage: 24 VDC**



	24 VDC	10 A	≥ 95 %	10 ... 600 s	LineMonitor; communication capability	40 x 163 x 163	787-870
	24 VDC	20 A	≥ 95 %	10 ... 600 s	LineMonitor; communication capability	57 x 171 x 163	787-875
	24 VDC	40 A	≥ 97 %	Load-dependent	Charging current ≤ 4 A	68 x 181 x 162	787-915

Illustration	Nominal Input Voltage	Output Current	Capacitance	Charging current	Features	Dimensions (W x H x D in mm)	Item No.
--------------	-----------------------	----------------	-------------	------------------	----------	------------------------------	----------

**Pure Lead Battery Module; output voltage 24 VDC**

	24 VDC	20 A	2.5 Ah	≤ 5 A	Battery Control -40 ... +60 °C	36 x 90 x 55	787-878/000-2500
	24 VDC	40 A	13 Ah	≤ 5 A	Battery Control -40 ... +60 °C	217 x 186 x 199.5	787-878/001-3000

**Lead Fleece Battery Module; output voltage: 24 VDC**

	24 VDC	7.5 A	1.2 Ah	≤ 0.3 A	Battery Control -10 ... +40 °C	55 x 153 x 126.6	787-876
	24 VDC	20 A	3.2 Ah	≤ 0.8 A	Battery control	76.2 x 168 x 175.5	787-871
	24 VDC	40 A	7 Ah	≤ 1.8 A	Battery control	86 x 239 x 217.5	787-872
	24 VDC	40 A	12 Ah	≤ 3 A	Battery control	120.5 x 239 x 217.5	787-873
	24 VDC	5 A	0.8 Ah	0.2 A	Battery Control -10 ... +40 °C	72 x 97 x 124	787-1671

Illustration	Nominal Input Voltage	Output Current	Buffer Time	Charging time, typ.	Features	Dimensions (W x H x D in mm)	Item No.
--------------	-----------------------	----------------	-------------	---------------------	----------	------------------------------	----------

**Capacitive Buffer Module; output voltage 24 VDC**

	24 VDC	10 A	0.06 ... 7.2 s	5 min	Communication capability	57 x 163 x 179	787-880
	24 VDC	20 A	0.17 ... 16.5 s	5 min	Communication capability	57 x 181 x 179	787-881
	24 VDC	40 A	0.3 ... 6.6 s	2.5 min		68 x 181 x 162	787-916

Illustration	Nominal Input Voltage	Output Current	Efficiency	Signaling	Features	Dimensions (W x H x D in mm)	Item No.
--------------	-----------------------	----------------	------------	-----------	----------	------------------------------	----------

**Redundancy Module; output voltage: DC 24 V**

	2 x 24 VDC	25 A	≥ 96 %	Diode		50 x 130 x 92	787-783
	2 x 24 VDC	25 A	≥ 96 %	Diode	Ⓢ approval	50 x 130 x 92	787-783/000-040
	2 x 24 VDC	40 A	≥ 99.5 %	MOSFET	Communication capability	42 x 127 x 139.5	787-1685
	2 x 24 VDC	40 A	≥ 97 %	Diode	Communication capability	40 x 181 x 163	787-885
	2 x 24 VDC	76 A	≥ 97 %	Diode		83 x 130 x 153	787-785
	2 x 24 VDC	76 A	≥ 97 %	Diode	Ⓢ approval	83 x 130 x 153	787-785/000-040

**Redundancy Module; output voltage: DC 48 V**

	2 x 48 VDC	40 A	≥ 97 %		Communication capability	40 x 181 x 163	787-886
---	------------	------	--------	--	--------------------------	----------------	---------

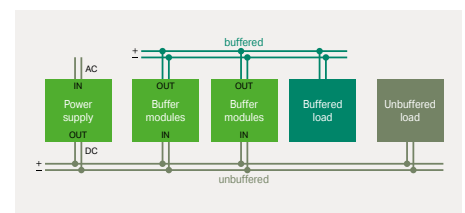
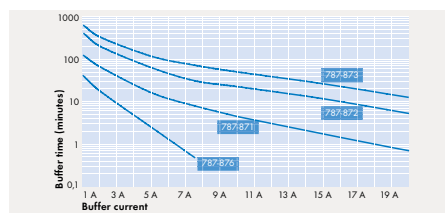
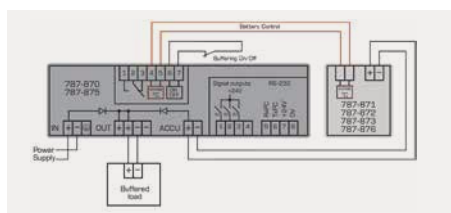

**Battery Control Technology**

- Allows continuous data exchange between intelligent Battery Modules (787-87x) and a UPS Charger/Controller
- Automatically detects a connected Battery Module (787-87x)
- Maximized battery life via temperature-controlled battery management

**Buffer Time vs. Load Current**

Different buffer times/currents can be achieved depending on the battery module selected. The example above shows a 7 A load current provided for approximately 30 seconds. The 787-870 UPS Charger/Controller (10 A) and 787-876 Battery Module are appropriate for this.

**Parallel Connection Possible**

- Multiple buffer modules can be connected in parallel to increase buffer time or load current

# WAGO Signal Conditioners – 857 / 2857 Series

## Selection Guide

	Illustration	Description	Circuit Diagram	Input Signal			Supply Voltage $U_s$
				Current	Voltage	Bipolar Signals (I/U)	
Signal conditioner							
Signal conditioner		Signal Conditioner; configurable; with digital output		0 ... 1 mA 0 ... 10 mA 2 ... 10 mA 0 ... 20 mA 4 ... 20 mA 0 ... 100 mA	0 ... 5 V 1 ... 5 V 0 ... 10 V 2 ... 10 V 0 ... 220 V	$\pm 1$ mA; $\pm 10$ mA; $\pm 20$ mA; $\pm 100$ mA  $\pm 1$ V; $\pm 10$ V; $\pm 30$ V; $\pm 100$ V; $\pm 200$ V	24 VDC
		Signal Conditioner; configurable; with zero/span adjustment		0 ... 10 mA 2 ... 10 mA 0 ... 20 mA 4 ... 20 mA	0 ... 5 V 1 ... 5 V 0 ... 10 V 2 ... 10 V		24 VDC
		Signal Conditioner; configurable; with digital output		0 ... 10 mA 2 ... 10 mA 0 ... 20 mA 4 ... 20 mA	0 ... 5 V 1 ... 5 V 0 ... 10 V 2 ... 10 V	$\pm 20$ mA  $\pm 10$ V	24 VDC
		Signal Conditioner; configurable; with zero/span adjustment		$\pm 0.3$ ... $\pm 100$ mA	$\pm 60$ mV ... $\pm 200$ V	$\pm 0.3$ ... $\pm 100$ mA  $\pm 60$ mV ... $\pm 200$ V	24 VDC
		Bipolar Signal Conditioner		0 ... 10 mA 2 ... 10 mA 0 ... 20 mA 4 ... 20 mA	0 ... 5 V 1 ... 5 V 0 ... 10 V 2 ... 10 V	$\pm 10$ mA $\pm 20$ mA  $\pm 5$ V $\pm 10$ V	24 VDC
		Signal Conditioner; pre-configured		0 (4) ... 20 mA  0 ... 20 mA 4 ... 20 mA	0 (2) ... 10 V 0 ... 10 V 0 ... 10 V		24 VDC
Isolation Amplifier		Isolation Amplifier		0 ... 20 mA 4 ... 20 mA			24 VDC
Signal Splitter		Signal Splitter; with current output		0 ... 20 mA 4 ... 20 mA	0 ... 5 V 1 ... 5 V 0 ... 10 V 2 ... 10 V		24 VDC
		Signal Splitter; with voltage/current output		0 ... 10 mA 2 ... 10 mA 0 ... 20 mA 4 ... 20 mA	0 ... 5 V 1 ... 5 V 0 ... 10 V 2 ... 10 V		24 VDC
Passive Isolator		Loop-Powered Isolator		0 ... 5 mA 0 ... 10 mA 2 ... 10 mA 0 ... 20 mA 4 ... 20 mA	0 ... 1 V 0 ... 5 V 1 ... 5 V 0 ... 10 V 2 ... 10 V	$\pm 5$ mA $\pm 10$ mA $\pm 20$ mA $\pm 1$ V; $\pm 5$ V $\pm 10$ V $\pm 20$ V	Via output circuit
		Passive Isolator; 1-channel		0 (4) ... 20 mA			Via input circuit
		Passive Isolator; 2-channel		2 x 0 (4) ... 20 mA			Via input circuit

For jumpers: see page 234.

Marking: WMB/WMB Inline/Marking strips

For suitable operating tool: see page 279

Output Signal			Configuration	Special Functions	Item No.
Current	Voltage	Bipolar Signals (I/U)			
0 ... 10 mA 2 ... 10 mA 0 ... 20 mA 4 ... 20 mA	0 ... 5 V 1 ... 5 V 0 ... 10 V 2 ... 10 V	±10 mA ±20 mA  ±5 V ±10 V	DIP switch; Interface Configuration software/app/ display	Digital output (DO); clipping; simulation	2857-401
0 ... 20 mA 4 ... 20 mA	0 ... 5 V 1 ... 5 V 0 ... 10 V 2 ... 10 V		DIP switch	Zero/span adjustment	857-400
0 ... 10 mA 2 ... 10 mA 0 ... 20 mA 4 ... 20 mA	0 ... 5 V 1 ... 5 V 0 ... 10 V 2 ... 10 V		DIP switch; Interface Configuration software/app	Digital output (DO); clipping	857-401
0 ... 20 mA 4 ... 20 mA	0 ... 5 V 1 ... 5 V 0 ... 10 V 2 ... 10 V	±10 mA ±20 mA  ±5 V ±10 V	DIP switch; push/slide switch		857-403
0 ... 10 mA 2 ... 10 mA 0 ... 20 mA 4 ... 20 mA	0 ... 5 V 1 ... 5 V 0 ... 10 V 2 ... 10 V	±10 mA ±20 mA  ±5 V ±10 V	DIP switch	Zero/span adjustment	857-409
0 (4) ... 20 mA					857-411
	0 (2) ... 10 V				857-412
0 ... 20 mA					857-413
4 ... 20 mA					857-414
	0 ... 10 V 0 ... 10 V				857-415 857-416
0 ... 20 mA 4 ... 20 mA	0 ... 5 V 1 ... 5 V 0 ... 10 V 2 ... 10 V		DIP switch		857-420
2 x 0 (4) ... 20 mA			DIP switch		857-423
2 x 0 ... 20 mA 4 ... 20 mA	2 x 0 ... 10 V 2 ... 10 V		DIP switch		857-424
4 ... 20 mA			DIP switch	Zero/span adjustment	857-450
0 (4) ... 20 mA					857-451
2 x 0 (4) ... 20 mA					857-452

# WAGO Current and Voltage Signal Conditioners – 857 / 2857 Series

## Selection Guide

Illustration	Description	Circuit Diagram	Input Signal			Supply Voltage $U_s$
			Current	Voltage	Bipolar Signals (I/U)	
<b>Current and Voltage Signal Conditioners</b>						
	Through-Hole Current Signal Conditioner		100 A AC/DC			24 VDC
	Current Signal Conditioner		1 A AC/DC 5 A AC/DC			24 VDC
	Current Signal Conditioner		0 ... 5 A AC/DC (IN 1; block arrangement); 0 ... 6 A AC/DC (IN 1; individual arrangement); 0 ... 1 A AC/DC (IN 2)			24 VDC
	Current Signal Conditioner; for Rogowski Coils		Rogowski Coils 500 AAC 2000 AAC			24 VDC
	Voltage Signal Conditioner		300 VAC/DC			24 VDC
	Power Measurement Module		300 VAC/DC (5 A)			24 VDC
	Millivolt Signal Conditioner			0 ... 200 mV 0 ... 1000 mV	±100 mV	24 VDC
	1-Phase Power Measurement Module		1 A AC/DC 5 A AC/DC 8 A AC/DC	500 VAC/DC 300 VAC/DC 250 VAC/DC 30 VAC/DC		24 VDC
	3-Phase Power Measurement Module		Via current transformer sec. 1 A	400 VAC (ULN); 690 VAC (ULL)		24 VDC
	3-Phase Power Measurement Module		Via current transformer sec. 5 A	400 VAC (ULN); 690 VAC (ULL)		24 VDC
	3-Phase Power Measurement Module		Via RC 70, RC 125 and RC 175 Rogowski coils	400 VAC (ULN); 690 VAC (ULL)		24 VDC



Commoning

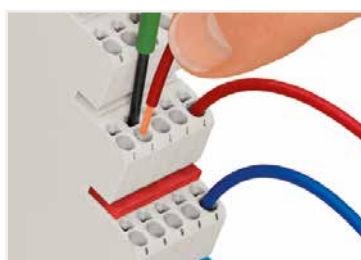

Conductor connection

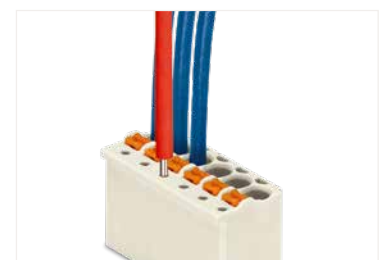

Testing with test pin (735-500)



Output Signal			Configuration	Special Functions	Item No.
Current	Voltage	Bipolar Signals (I/U)			
0 ... 10 mA 2 ... 10 mA 0 ... 20 mA 4 ... 20 mA	0 ... 5 V 1 ... 5 V 0 ... 10 V 2 ... 10 V	±10 mA ±20 mA ±5 V ±10 V	DIP switch; Interface Configuration software/app/display	Digital output (DO); clipping; zero/span adjustment; simulation	2857-550
0 ... 10 mA 2 ... 10 mA 0 ... 20 mA 4 ... 20 mA	0 ... 5 V 1 ... 5 V 0 ... 10 V 2 ... 10 V		DIP switch; Interface Configuration software/app	Digital output (DO); clipping	857-550
0 ... 10 mA; 2 ... 10 mA; 0 ... 20 mA; 4 ... 20 mA (can be inverted, also bipolar)	0 ... 5 V; 1 ... 5 V; 0 ... 10 V; 2 ... 10 V (can be inverted, also bipolar)		DIP switch; Interface Configuration software		857-551
0 ... 10 mA 2 ... 10 mA 0 ... 20 mA 4 ... 20 mA	0 ... 5 V 1 ... 5 V 0 ... 10 V 2 ... 10 V		DIP switch; Interface Configuration software/app	Digital output (DO); clipping	857-552
0 ... 10 mA 2 ... 10 mA 0 ... 20 mA 4 ... 20 mA	0 ... 5 V 1 ... 5 V 0 ... 10 V 2 ... 10 V		DIP switch; Interface Configuration software/app	Digital output (DO); clipping	857-560
0 ... 10 mA 2 ... 10 mA 0 ... 20 mA 4 ... 20 mA	0 ... 5 V 1 ... 5 V 0 ... 10 V 2 ... 10 V		DIP switch; Interface Configuration software/app	Digital output (DO); clipping	857-569
0 ... 10 mA 2 ... 10 mA 0 ... 20 mA 4 ... 20 mA	0 ... 5 V 1 ... 5 V 0 ... 10 V 2 ... 10 V		DIP switch; Interface Configuration software/app	Clipping	857-819
		±12 V ±24 mA	Interface Configuration software/app	Digital output (DO)	2857-569
			Interface Configuration software		2857-570/024-001
			Interface Configuration software		2857-570/024-005
			Interface Configuration software		2857-570/024-000

8



Marking Strips



Micro-WSB Marking System



WMB Marking System

# WAGO Temperature Signal Conditioners – 857 / 2857 Series

## Selection Guide

Illustration	Description	Circuit Diagram	Input Signal	Sensor Connection	Supply Voltage $U_s$
<b>Temperature Signal Conditioner</b>					
	Temperature Signal Conditioner; for Pt and resistance sensors		Pt sensors: Pt100, Pt200, Pt500, Pt1000; resistance sensors: 0 ... 1 k $\Omega$ ; 0 ... 4.5 k $\Omega$	2-, 3-, 4-wire connection	24 VDC
	Temperature Signal Conditioner; for Pt and resistance sensors		Pt sensors: Pt100, Pt200, Pt500, Pt1000; resistance sensors: 0 ... 1 k $\Omega$ ; 0 ... 4.5 k $\Omega$	2-, 3-, 4-wire connection	24 VDC
	Temperature Signal Conditioner; for Pt46 and Cu53 sensors		Pt46; Cu53	2-, 3-, 4-wire connection	24 VDC
	Temperature Signal Conditioner; for thermocouples		Thermocouple: type J, K		24 VDC
	Temperature Signal Conditioner; for thermocouples		Thermocouple: type J, K, E, R, N, S, T, B, S		24 VDC
	Temperature Signal Conditioner; for thermocouples		Thermocouple: Type K, S, B, R		24 VDC
	Loop-Powered RTD Temperature Signal Conditioner		Pt sensors: Pt100, Pt200, Pt500, Pt1000; resistance sensors: 0 ... 1 k $\Omega$ ; 0 ... 4.5 k $\Omega$	2-, 3-, 4-wire connection	Via output circuit
	Temperature Signal Conditioner; for Ni sensors		Ni sensors: Ni100, Ni120, Ni200, Ni500, Ni1000	2-, 3-, 4-wire connection	24 VDC
	Temperature Signal Conditioner; for KTY sensors		KTY sensors	2-wire connection	24 VDC
	RTD/TC Temperature Signal Conditioner; analog		RTD sensors; potentiometers; resistors; thermocouples	2-, 3-, 4-wire connection; differential measurement; potentiometer	9.6 ... 31.2 VDC
	RTD/TC Temperature Signal Conditioner; serial		RTD sensors; potentiometers; resistors; thermocouples	2-, 3-, 4-wire connection; differential measurement; potentiometer	9.6 ... 31.2 VDC



DIP switch



Push/slide switch (857 Series only)



Interface Configuration software, with 750-923 USB Communication Cable

Sensor Temperature Range	Output Signal			Configuration	Special Functions	Item No.
	Current	Voltage	RS-485			
-200 ... +850 °C	0 ... 10 mA 2 ... 10 mA 0 ... 20 mA 4 ... 20 mA	0 ... 5 V 1 ... 5 V 0 ... 10 V 2 ... 10 V		DIP switch	Clipping	857-800
-200 ... +850 °C	0 ... 10 mA 2 ... 10 mA 0 ... 20 mA 4 ... 20 mA	0 ... 5 V 1 ... 5 V 0 ... 10 V 2 ... 10 V		DIP switch; configuration software/app	Clipping	857-801
-200 ... +300 °C (Pt46) 0 ... +180 °C (Cu53)	0 ... 10 mA 2 ... 10 mA 0 ... 20 mA 4 ... 20 mA	0 ... 5 V 1 ... 5 V 0 ... 10 V 2 ... 10 V		DIP switch		857-808
Type J: -150 ... +1200 °C; Type K: -150 ... +1350 °C	0 ... 10 mA 2 ... 10 mA 0 ... 20 mA 4 ... 20 mA	0 ... 5 V 1 ... 5 V 0 ... 10 V 2 ... 10 V		DIP switch	Clipping	857-810
Type J: -150 ... +1200 °C; Type K: -150 ... +1350 °C	0 ... 10 mA 2 ... 10 mA 0 ... 20 mA 4 ... 20 mA	0 ... 5 V 1 ... 5 V 0 ... 10 V 2 ... 10 V		DIP switch; configuration software/app	Clipping	857-811
Type K: -150 ... +1200 °C; Type S: 0 ... +1600 °C; Type B: 600 ... +1800 °C; Type R: 0 ... +1600 °C	0 ... 10 mA 2 ... 10 mA 0 ... 20 mA 4 ... 20 mA	0 ... 5 V 1 ... 5 V 0 ... 10 V 2 ... 10 V		DIP switch		857-812
-200 ... +850 °C	4 ... 20 mA 20 ... 4 mA			DIP switch		857-815
	0 ... 10 mA 2 ... 10 mA 0 ... 20 mA 4 ... 20 mA	0 ... 5 V 1 ... 5 V 0 ... 10 V 2 ... 10 V		DIP switch	Clipping	857-818
	0 ... 10 mA 2 ... 10 mA 0 ... 20 mA 4 ... 20 mA	0 ... 5 V 1 ... 5 V 0 ... 10 V 2 ... 10 V		DIP switch	Digital output DO; clipping	857-820
-200 ... +850 °C; 0 ... 10 kΩ; Type J: -210 ... +1200 °C; Type K: -200 ... +1372 °C	-24 ... +24 mA (load impedance ≤ 600 Ω)	-12 ... +12 V (load impedance ≥ 2 kΩ)		Configuration software/ display	Digital output DO; relay with 1 changeover contact (250 VAC / 6 A); simulation	2857-535
-200 ... +850 °C; 0 ... 10 kΩ; Type J: -210 ... +1200 °C; Type K: -200 ... +1372 °C			Modbus RTU	Configuration software/ display; rotary encoder switch	Relay with 1 changeover contact (250 VAC / 6 A); simulation	2857-535/000-001

8



2857-900 Configuration Display (2857 Series only)

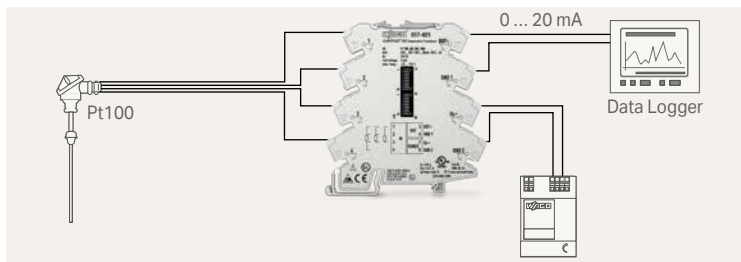









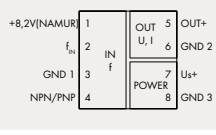

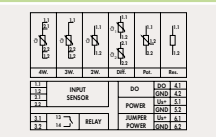

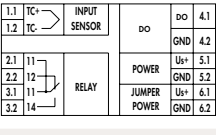

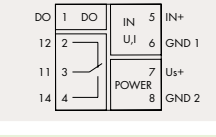
857-801 Temperature Signal Conditioner application example (for more examples, see www.wago.com)

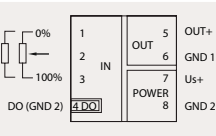
# WAGO Signal Conditioners with Special Functions – 857 Series

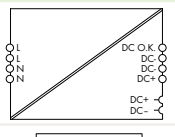
## WAGO Threshold Value Switches – 857 / 2857 Series

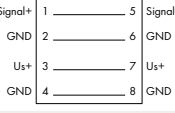
### Selection Guide

Illustration	Description	Circuit Diagrams	Input Signal			
			Frequencies			
<b>Frequency Signal Conditioner</b>						
	Frequency Signal Conditioner	 <p>+8,2V(NAMUR) 1 OUT 5 OUT+ f<sub>max</sub> 2 IN U, 1 6 GND 2 GND 1 3 f 7 Us+ NPN/PNP 4 POWER 8 GND 3</p>	Frequency signals; NAMUR/NPN or PNP sensors 0.1 ... 120 kHz			
<b>Threshold Value Switch</b>						
	RTD Threshold Value Switch					0 ... 100 kΩ; Pt100; Pt200; Pt500; Pt1000; Pt5000; Pt10,000; Pt10 ... 20,000
	Thermocouple Threshold Value Switch					Type J, K, E, N, R, S, T, B, C
	Analog Threshold Value Switch		0 ... 10 mA 2 ... 10 mA 0 ... 20 mA 4 ... 20 mA	0 ... 5 V; 1 ... 5 V; 0 ... 10 V; 2 ... 10 V; 0 ... 15 V; 0 ... 30 V	±10 mA ±20 mA ±5 V ±10 V	
<b>Signal Conditioners with Special Functions</b>						
	Potentiometer Signal Conditioner		0 ... 100 kΩ			10 ... 100 kΩ
<b>Accessories</b>						
	Switched-Mode Power Supply in 2857 Series Housing					Item No. 787-2852 PU 1
	Supply and Through Module					Item No. 857-979 PU 25
	Push-in Type Jumper Bar; insulated; light gray; I <sub>N</sub> : 18 A					Item No. 859-402 PU 25
	○ 2-way					Item No. 859-403 PU 25
	○ 3-way					Item No. 859-410 PU 25
	○ 10-way					Item No. .../000-029 PU
	● Yellow					Item No. .../000-005 PU
	● Red					Item No. .../000-006 PU
	● Blue					Item No. 281-482 PU 25
	Comb-Style Jumper Bar for Clamping Unit; I <sub>N</sub> 32 A; 2-way					Item No. 281-482 PU 25

Marking: WMB/WMB Inline/Marking strips For suitable operating tool: see page 279.

Supply Voltage U <sub>s</sub>	Output Signal		Configuration	Special Functions	Item No.
	Current	Voltage			
24 VDC	0 ... 10 mA 2 ... 10 mA 0 ... 20 mA 4 ... 20 mA	0 ... 5 V 1 ... 5 V 0 ... 10 V 2 ... 10 V	DIP switch; Interface Configuration software/app	Clipping	857-500





  

Supply Voltage U <sub>s</sub>	Output Signal		Configuration	Special Functions	Item No.
	Relay (1 changeover contact)	Relay (1 make contact)			
24 VDC		250 VAC 6 A	DIP switch; Interface Configuration software/app/display	Digital output DO; relay with 1 make contact (250 VAC / 6 A); simulation	2857-533
24 VDC	250 VAC 6 A		DIP switch; Interface Configuration software/app/display	Digital output DO; relay with 1 changeover contact (250 VAC / 6 A); simulation	2857-534
24 VDC	250 VAC 6 A		DIP switch; push/slide switch; Interface Configuration software/app	Digital output DO; relay with 1 changeover contact (250 VAC/6 A)	857-531

Supply Voltage U <sub>s</sub>	Output Signal		Configuration	Special Functions	Item No.
	Current	Voltage			
24 VDC	0 ... 10 mA 2 ... 10 mA 0 ... 20 mA 4 ... 20 mA	0 ... 5 V 1 ... 5 V 0 ... 10 V 2 ... 10 V	DIP switch; push/slide switch; Interface Configuration software/app	Clipping	857-809

**Accessories**

Illustration	Description	Item No.
	Configuration Display	2857-900
	Interface Adapter; with 16-pin ribbon cable connector according to DIN 41651, for use with signal conditioners	857-980
	Ribbon Cable; 16-pole; with free end; length: 2 m	706-100/1602-200
	WAGO USB Communication Cable, connection between PC and coupler/controller/signal conditioner	
	2.5 m	750-923
	5 m	750-923/000-001

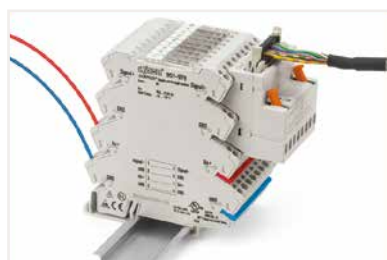

Application example for 857-980 Interface Adapter and 706-100/1602-200 Ribbon Cable



Application example for 281-482 Comb-Style Jumper Bar plugged into conductor entry

# WAGO Relay Modules System Overview and Usage

Relay and Optocoupler Modules,  
857 Series

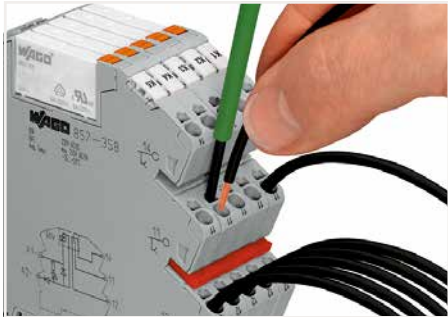

Inserting a conductor

Relay and Optocoupler Modules,  
859 Series

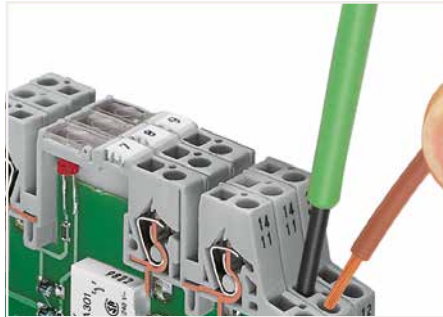

Inserting a conductor

Sockets with Miniature Switching Relay,  
788 Series

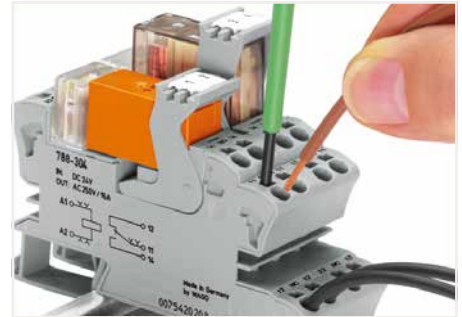

Conductor termination

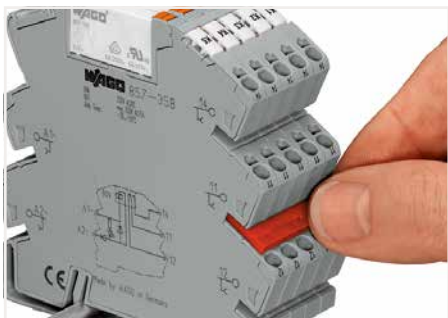

Easy commoning using adjacent jumpers

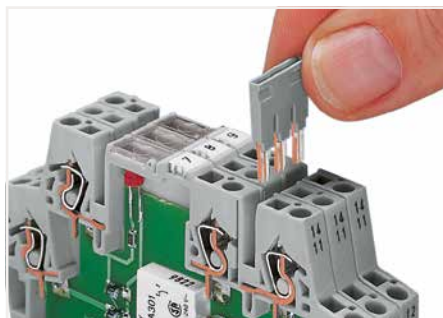

Easy commoning using adjacent jumpers



Easy commoning using adjacent jumpers



Marking option with marking strips



Ability to mark via Mini-WSB Quick Marking System

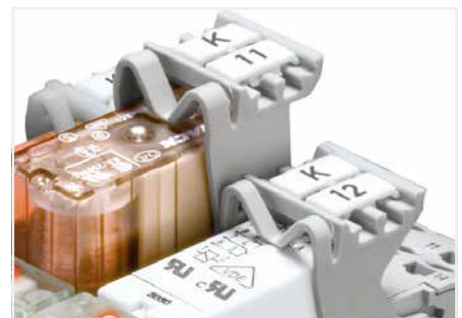

Option of marking using WMB Multi marking system and group marker carriers



Removing a relay via ejector



LED status indication



Relay socket with ejector

8

# WAGO Relay Modules System Overview and Usage

## Sockets with Industrial Relay, 858 Series

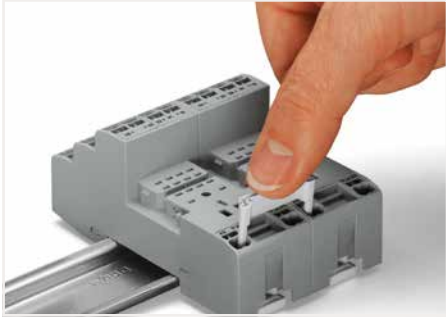

Easy commoning using adjacent jumpers

## Relay Modules in DIN-Rail-Mount Enclosure, 789 Series

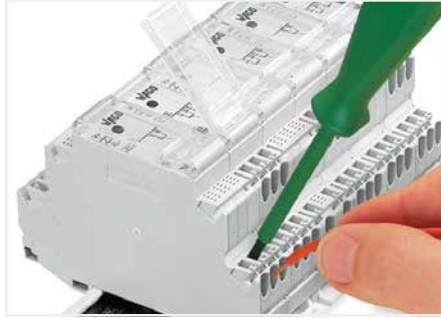

Conductor termination

## Mounting Carriers with Miniature Switching Relay, 288 Series

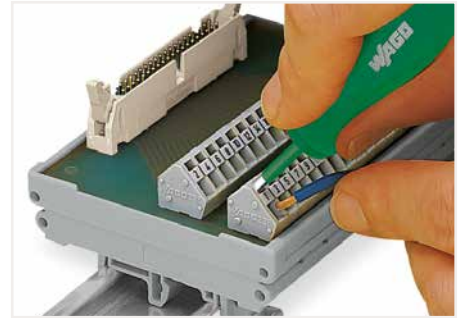

Connecting conductor – front-entry wiring

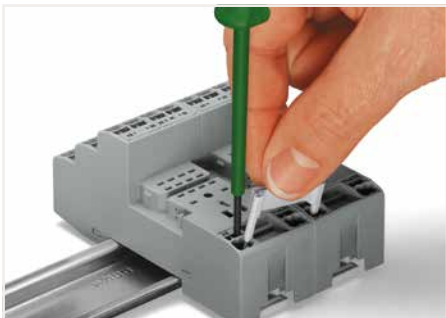

Removing a conductor via screwdriver



Easy commoning via adjacent jumpers

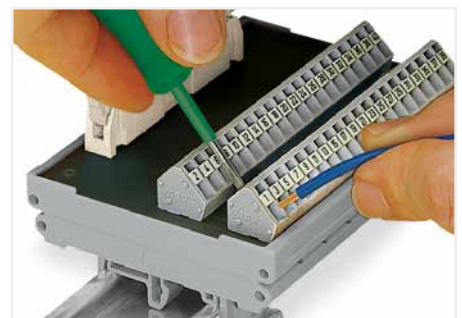

Connecting conductor – side-entry wiring



Option of marking using WMB Multi marking system and group marker carriers



Option of marking via Mini-WSB Quick Marking System

## Pluggable Function Modules for Carrier Terminal Blocks, 2042 Series

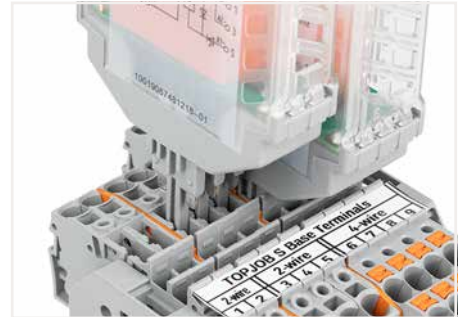

Coding ensures correct polarity

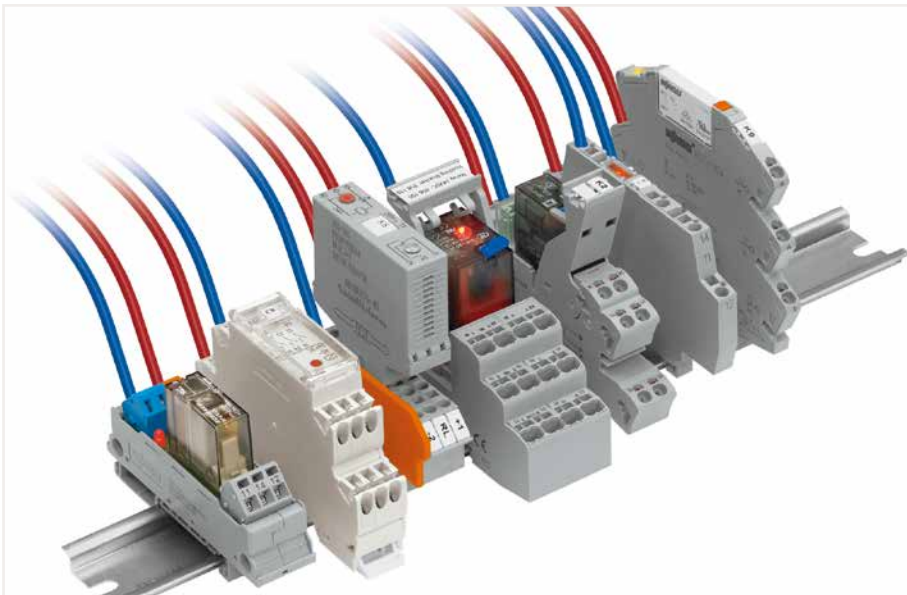

Function testing via touch-proof test slots

# WAGO Relay Modules – 857 Series

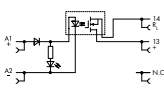

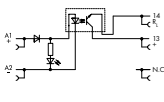

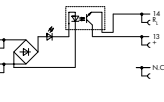



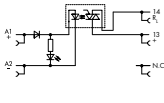

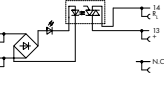



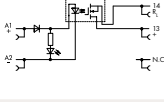

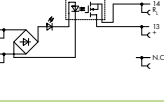



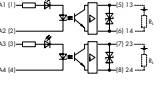

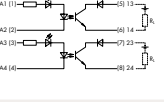

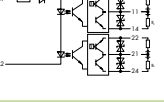

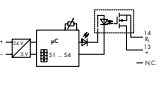

Illustration	Circuit Diagram	Nominal Input Voltage	Approval	Max. Switching Voltage	Limiting Continuous Current	Specialty Function	Item No.
<b>Relay Module; 1 changeover contacts; installation width: 6 mm</b>							
		12 VDC	UL, ☉	250 VAC	6 A		857-303
		24 VDC	GL, UL, ☉	250 VAC	6 A		857-304
		24 VDC	GL, UL, ☉	250 VAC	6 A	With gold contacts	857-314
		24 VAC/DC	UL, ☉	250 VAC	6 A		857-354
		24 VAC/DC	UL, ☉	250 VAC	6 A	With gold contacts	857-364
		115 VAC/DC	UL, ☉	250 VAC	6 A		857-357
		115 VAC/DC	UL, ☉	250 VAC	6 A	With gold contacts	857-367
		230 VAC/VDC	GL, UL, ☉	250 VAC	6 A		857-358
		230 VAC/VDC	GL, UL, ☉	250 VAC	6 A	With gold contacts	857-368
		230 VAC/VDC		250 VAC	6 A	With integrated base load module	857-358/006-000
		230 VAC/VDC		250 VAC	6 A	With integrated base load module	857-358/006-000
		230 VAC/VDC		250 VAC	6 A	With integrated base load module; with gold contacts	857-368/006-000
		24 ... 230 VAC/DC	UL	250 VAC	6 A		857-359
		24 ... 230 VAC/DC	UL	250 VAC	6 A	With gold contacts	857-369
<b>Relay Module; 2-way; 1 make contact; installation width: 6 mm</b>							
		24 VAC/DC	UL, ☉	250 VAC	4 A		857-1330
<b>Timer Relay Module; 1 changeover contact; for railway applications; multifunctional/multi-time; installation width: 6 mm</b>							
		24 VDC	UL	250 VAC	6 A	14 time functions; DIP switch	857-640
		24 VDC	UL	250 VAC	6 A	7 time functions; DIP switch	857-642
		24 VDC	UL	250 VAC	6 A	4 time functions; DIP switch	857-604
<b>Accessories</b>							
Illustration	Circuit Diagram	Description	Nominal Voltage	Current Carrying Capacity per Channel	Limiting Continuous Current	Item No.	Pack. Unit
		8-Way Adapter; with 14-pole pluggable connector; high-side switching input; use on the coil side of the 857 Relay Module	24 VDC	1 A	2.5 A	857-981	1
		8-Way Adapter; with 14-pole pluggable connector; high-side switching output; use on the contact side of the 857 Relay Module	24 VDC	1 A	2.5 A	857-982	1
		8-Way Adapter; with D-sub male header; with 15-pole pluggable connector; high-side switching input; use on the coil side of the 857 Relay Module	24 VDC	1 A	2.5 A	857-986	1
		Push-in Type Jumper Bar; light gray; insulated; I <sub>N</sub> 18 A					
		○ 2-way				859-402	25
		⋮				⋮	
		○ 10-way				859-410	25
		● Yellow				.../000-029	
		● Red				.../000-005	
● Blue				.../000-006			

Marking: WMB/Marking Strips

Operating Tool: 210-720

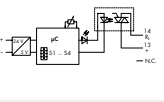

# WAGO Solid-State Relay and Optocoupler Modules – 857 Series

Illustration	Circuit Diagram	Nominal Input Voltage	Approval	Output Voltage Range	Limiting Continuous Current	Specialty Function	Item No.
<b>Solid-State Relay Module; 2-wire connection; installation width: 6 mm</b>							
		24 VDC (SELV)	UL	1 ... 30 VDC	8 A	For railway applications	857-734
		24 VDC	UL, 	0 ... 48 VDC	0.1 A		857-704
		115 VAC/DC	UL, 	0 ... 48 VDC	0.1 A		857-707
		230 VAC/VDC	UL, 	0 ... 48 VDC	0.1 A		857-708
		24 VDC	UL, 	24 ... 240 VAC	2 A	Zero-voltage switching	857-714
		115 VAC/DC	UL, 	24 ... 240 VAC	2 A	Zero-voltage switching	857-717
		230 VAC/VDC	UL, 	24 ... 240 VAC	2 A	Zero-voltage switching	857-718
		24 VDC	GL, UL, 	0 ... 31.2 VDC	3 A		857-724
		115 VAC/DC	UL, 	0 ... 31.2 VDC	3 A		857-727
		230 VAC/VDC	UL, 	0 ... 31.2 VDC	3 A		857-728
<b>Optocoupler Module; 2-way; 2-wire connection; installation width: 6 mm</b>							
		24 VDC	GL, UL, 	3 ... 31.2 VDC	3 A		857-1430
		24 VDC	UL	9 ... 60 VDC	0.1 A		857-1494
		24 VDC	UL	9 ... 60 VDC	0.5 A	2 changeover contacts; high-side switching	857-1432
<b>Solid-State Time Relay Module; 2-wire connection; multi-function/multi-time; installation width: 6 mm</b>							
		24 VDC	UL	0 ... 31.2 VDC	2 A	4 time functions; DIP switch	857-624
		24 VDC	UL	24 ... 240 VAC	1 A	4 time functions; DIP switch	857-634

# WAGO Relay Modules – 859 Series

Illustration	Circuit Diagram	Nominal Input Voltage	Nominal Input Current	Max. Switching Voltage	Limiting Continuous Current	Specialty Function	Item No.
<b>Relay Module; 1 changeover contacts; installation width: 6 mm</b>							
		5 VDC	31 mA	250 VAC	5 A		859-302
		5 VDC	31 mA	250 VAC	5 A	With gold contacts	859-312
		12 VDC	17 mA	250 VAC	5 A		859-303
		24 VDC	10 mA	250 VAC	5 A		859-304
		24 VDC	10 mA	250 VAC	5 A	With gold contacts	859-314
		48 VDC	6.5 mA	250 VAC	5 A		859-305
		110 VDC	3.5 mA	250 VAC	5 A		859-307
		220 VDC	3.2 mA	250 VAC	5 A		859-308
		220 VDC	3.2 mA	250 VAC	5 A	With gold contacts	859-318
		12 VAC/DC	15 mA	250 VAC	5 A		859-353
		24 VAC/DC	8 mA	250 VAC	5 A		859-354
		48 VAC/DC	5.3 mA	250 VAC	5 A		859-355
		115 VAC/DC	3.5 mA	250 VAC	5 A		859-357
		115 VAC/DC	3.5 mA	250 VAC	5 A	With gold contacts	859-360
		230 VAC/VDC	3.5 mA	250 VAC	5 A	With gold contacts	859-359
		24 VDC	12 mA	250 VAC	5 A	For railway applications	859-390
		24 VDC	10 mA	250 VAC	5 A	With gold contacts, for railway applications	859-392
		36 VDC	10.1 mA	250 VAC	5 A	With gold contacts, for railway applications	859-386
		48 VDC	7.9 mA	250 VAC	5 A	With gold contacts, for railway applications	859-384
		110 VDC	2.7 mA	250 VAC	5 A	For railway applications	859-391
		110 VDC	3.1 mA	250 VAC	5 A	With gold contacts, for railway applications	859-317
		24 VDC	14.4 mA	250 VAC	5 A	For railway applications	859-398
		48 VDC	7.9 mA	250 VAC	5 A	For railway applications	859-397
		110 VDC	3.1 mA	250 VAC	5 A	For railway applications	859-399
		115 VAC	4.2 mA	250 VAC	5 A	With specified switch-on threshold	859-367
		230 VAC	4.2 mA	250 VAC	5 A	With specified switch-on threshold	859-368

Accessories			
Illustration	Description	Item No.	PU
	End and Intermediate Plate; 1 mm thick; gray	859-525	25
	Push-in Type Jumper Bar; light gray; insulated; I <sub>N</sub> 18 A		
	○ 2-way	859-402	25
	⋮	⋮	
	○ 10-way	859-410	25
	● Yellow	.../000-029	
	● Red	.../000-005	
	● Blue	.../000-006	

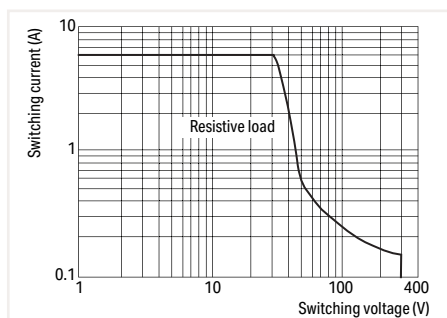

DC load limit curve

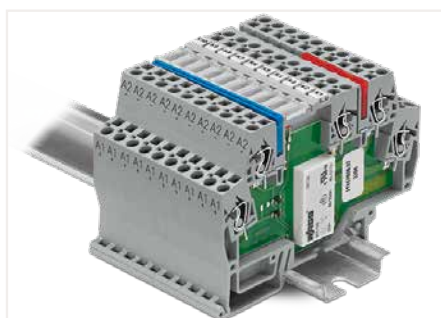

### Contact Type







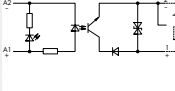
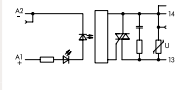

The three most important contact types (also called the contact spring set) are make contact, break contact and changeover contact.

They are abbreviated as follows:

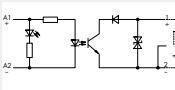
Germany	UK	US
Schließer 1	Make A	SPST-NO (normally open)
Öffner 2	Break B	SPST-NC (normally closed)
Wechsler 21	Changeover	SPDT

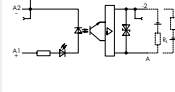
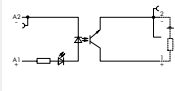
Marking: WMB/Mini-WSB

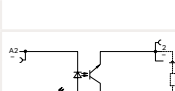
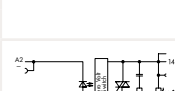
# WAGO Optocoupler Modules – 859 Series

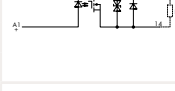
Illustration	Circuit Diagram	Nominal Input Voltage	Nominal Input Current	Output Voltage Range	Limiting Continuous Current	Specialty Function	Item No.
<b>Optocoupler Module; 2-wire connection; installation width: 6 mm</b>							
		5 VDC	7.5 mA	3 ... 60 VDC	0.1 A	For railway applications	859-793
		5 VDC	7.7 mA	24 ... 260 VAC	0.5 A	Zero-voltage switching	859-902
		5 VDC	17 mA	3 ... 30 VDC	0.1 A	For railway applications; frequency: 10 kHz	859-795
		5 VDC	7.2 mA	3 ... 30 VDC	5 A		859-738
		12 VDC	3.2 mA	3 ... 30 VDC	5 A		859-739
		24 VDC	3.5 mA	3 ... 30 VDC	5 A		859-737
		12 VDC	4 mA	9 ... 60 VDC	0.1 A	For railway applications	859-798
		12 VDC	9.2 mA	3 ... 30 VDC	0.5 A		859-797
		12 ... 48 VDC	5 mA	3 ... 53 VDC	4 A		859-744
		24 VDC	4 mA	7 ... 60 VDC	0.1 A	For railway applications	859-791
		24 VDC	4.2 mA	9 ... 60 VDC	0.1 A	For railway applications	859-794
		24 VDC	6 mA	24 ... 260 VAC	0.5 A	Zero-voltage switching	859-734
		24 VDC	7 mA	3 ... 30 VDC	3 A		859-740
		24 VDC	7 mA	3 ... 30 VDC	3 A		859-762
		24 VDC	14 mA	3 ... 30 VDC	3 A		859-730
		24 VDC	14 mA	3 ... 30 VDC	3 A		859-761
		24 VDC	9.2 mA	3 ... 30 VDC	0.1 A	For railway applications; frequency: 10 kHz	859-796

# WAGO Optocoupler Modules – 859 Series

Illustration	Circuit Diagram	Nominal Input Voltage	Nominal Input Current	Output Voltage Range	Limiting Continuous Current	Specialty Function	Item No.
<b>Optocoupler Module; 3-wire connection; installation width: 6 mm</b>							
		5 VDC	8 mA	4 ... 6.25 VDC	0.5 A	High-side switching; frequency: 10 kHz	859-750
		5 VDC	9.6 mA	20 ... 30 VDC	0.5 A	Low-side switching; frequency: 10 kHz	859-702
		5 VDC	10 mA	20 ... 30 VDC	0.5 A	High-side switching; frequency: 10 kHz	859-752
		5 VDC	16.5 mA	20 ... 28.8 VDC	0.1 A	High-side switching; frequency: 100 kHz	859-753
		24 VDC	9 mA	20 ... 28.8 VDC	0.1 A	High-side switching; frequency: 100 kHz	859-759
		24 VDC	4 mA	10 ... 30 VDC	3 A	Low-side switching	859-720
		24 VDC	5.3 mA	3 ... 30 VDC	0.5 A	1 changeover contact	859-732
		24 VDC	7.7 mA	20 ... 30 VDC	0.5 A	Low-side switching; frequency: 10 kHz	859-708
		24 VDC	8 mA	20 ... 30 VDC	0.5 A	High-side switching; frequency: 10 kHz	859-758
		24 VDC	9 mA	4 ... 6 VDC	0.1 A	High-side switching; frequency: 100 kHz	859-755
		24 VDC	11 mA	4 ... 6.25 VDC	0.5 A	High-side switching; frequency: 10 kHz	859-756
		24 VDC	11 mA	4 ... 6.25 VDC	0.5 A	Low-side switching; frequency: 10 kHz	859-706
		230 VAC	0.6 mA	20 ... 30 VDC	0.5 A	Low-side switching	859-712
		230 VAC	0.6 mA	20 ... 30 VDC	0.5 A	High-side switching	859-772

<b>Accessories</b>			
Illustration	Description	Item No.	PU
	End and Intermediate Plate; 1 mm thick; gray	859-525	25
	Push-in Type Jumper Bar; light gray; insulated; I <sub>N</sub> 18 A		
	2-way	859-402	25
	10-way	859-410	25

8

## WAGO Relay Modules – 788 Series

Illustration	Circuit Diagram	Nominal Input Voltage	Nominal Input Current	Max. Switching Voltage	Limiting Continuous Current	Specialty Function	Item No.
<b>Relay Module; 1 changeover contacts; installation width: 15 mm</b>							
		12 VDC	36 mA	250 VAC	16 A		788-303
		24 VDC	19 mA	250 VAC	16 A		788-304
		24 VDC	19 mA	250 VAC	16 A	With gold contacts	788-404
		48 VDC	11 mA	250 VAC	16 A		788-305
		60 VDC	115 mA	250 VAC	16 A		788-306
		110 VDC	6 mA	250 VAC	16 A		788-307
		24 VAC	34 mA	250 VAC	16 A		788-506
		115 VAC	8 mA	250 VAC	16 A		788-507
		115 VAC	8.2 mA	250 VAC	16 A	With gold contacts	788-607
		230 VAC	3.5 mA	250 VAC	16 A		788-508
		230 VAC	5 mA	250 VAC	16 A	With gold contacts	788-608
		12 VDC	35 mA	250 VAC	16 A	For lamp loads	788-353
		24 VDC	19 mA	250 VAC	16 A	For lamp loads	788-354
		24 VDC	16.7 mA	250 VAC	16 A	With manual operation	788-341
		24 VAC	31.6 mA	250 VAC	16 A	With manual operation	788-541
		115 VAC	6.6 mA	250 VAC	16 A	With manual operation	788-543
		230 VAC	3.2 mA	250 VAC	16 A	With manual operation	788-544
<b>Relay Module; 2 changeover contacts; installation width: 15 mm</b>							
		12 VDC	36 mA	250 VAC	8 A		788-311
		24 VDC	19 mA	250 VAC	8 A		788-312
		24 VDC	17 mA	250 VAC	8 A	With gold contacts	788-412
		48 VDC	11 mA	250 VAC	8 A		788-313
		60 VDC	11 mA	250 VAC	8 A		788-314
		110 VDC	6 mA	250 VAC	8 A		788-315
		24 VAC	34 mA	250 VAC	8 A		788-512
		115 VAC	8 mA	250 VAC	8 A		788-515
		115 VAC	8.2 mA	250 VAC	8 A	With gold contacts	788-615
		230 VAC	3.5 mA	250 VAC	8 A		788-516
		230 VAC	5 mA	250 VAC	8 A	With gold contacts	788-616
		24 VDC	31 mA	250 VAC	6 A	With force-guided contacts	788-384
		24 VDC	30 mA	250 VAC	0.3 A	With force-guided contacts; with gold contacts	788-906
		24 VDC	16.7 mA	250 VAC	8 A	With manual operation	788-346
		24 VDC	19.1 mA	250 VAC	8 A	With manual operation; for railway applications	788-390
		24 VAC	31.6 mA	250 VAC	8 A	With manual operation	788-546
		115 VAC	6.6 mA	250 VAC	8 A	With manual operation	788-548
		230 VAC	3.2 mA	250 VAC	8 A	With manual operation	788-549
<b>Relay Module; 1 make contact; installation width: 15 mm</b>							
		24 VDC	19 mA	250 VAC	16 A	For lamp loads	788-356
		24 VDC	17 mA	250 VAC	16 A	For lamp loads; pre-make contact W	788-357

### Accessories

Illustration	Description	Item No.	PU
	Comb-Style Jumper Bar; insulated; I <sub>N</sub> 18 A		
	2-way	788-113	25
	⋮	⋮	
	8-way	788-117	25
	1 to 3	788-118	25

# WAGO Solid-State Relay Modules – 788 Series

Illustration	Circuit Diagram	Nominal Input Voltage	Nominal Input Current	Output Voltage Range	Limiting Continuous Current	Specialty Function	Item No.
<b>Solid-State Relay Module; 2-wire connection; installation width: 15 mm</b>							
		24 VDC	11 mA	0 ... 35 VDC	5 A		788-710
		24 VDC	13 mA	12 ... 275 VAC	3.5 A	Zero-voltage switching	788-730
		24 VDC	7 mA	0 ... 24 VDC	3.5 A		788-700
		24 VDC	7 mA	24 ... 240 VAC	1 A	Zero-voltage switching	788-720
		24 VDC	9.3 mA	0 ... 30 VDC	5 A		788-701
		24 VAC/DC	10 mA	12 ... 275 VAC	4 A	Zero-voltage switching	788-721

<b>Accessories</b>						
Illustration	Description	Nominal Input Voltage	Switching Voltage, Max.	Lim. Continuous Current	Item No.	PU
	Socket for Miniature Switching Relay	Depends on relay; max. 250 VAC	250 V	16 A / 2 x 8 A		
	1 changeover contacts; height: 15 mm				788-100	20
	2 changeover contacts; height: 15 mm				788-102	20
	1 changeover contacts; height: 25 mm				788-101	15
	2 changeover contacts; height: 25 mm				788-103	15
	Status indicators					
	24 VDC (12 ... 24 V)				788-120	50
	48 VDC (48 ... 60 V)				788-121	50
	110 VDC				788-122	50
	24 VAC				788-123	50
	115 VAC				788-124	50
	230 VAC				788-125	50
	Suppressor Module for Socket; max. operating voltage 230 VAC; 50 ... 60 Hz				788-148	50
	Pluggable miniature switching relay (relay height: 15 mm)					
	1 changeover contact	12 VDC	250 VAC	16 A	788-150	20
		24 VDC			788-154	20
		48 VDC			788-158	20
		60 VDC			788-162	20
		110 VDC			788-166	20
		24 VAC			788-170	20
		115 VAC			788-174	20
	2 changeover contacts	230 VAC	250 VAC	2 x 8 A	788-178	20
		12 VDC			788-152	20
		24 VDC			788-156	20
		48 VDC			788-160	20
		60 VDC			788-164	20
		110 VDC			788-168	20
24 VAC		788-172			20	
115 VAC	788-176	20				
230 VAC	788-180	20				
	Push-in Type Jumper Bar; I <sub>max</sub> : 18 A					
	2-way				788-113	25
	8-way				788-117	25

Marking: WMB/Marking Strips

# WAGO Relay Modules – 858 Series

Illustration	Circuit Diagram	Nominal Input Voltage	Nominal Input Current	Max. Switching Voltage	Limiting Continuous Current	Specialty Function	Item No.
<b>Relay Module; 2 changeover contacts; installation width: 31 mm</b>							
		24 VDC	37.5 mA	250 VAC	12 A	With manual operation	858-324
		48 VDC	18.5 mA	250 VAC	12 A	With manual operation	858-325
		110 VDC	8.1 mA	250 VAC	12 A	With manual operation	858-327
		220 VDC	4.1 mA	250 VAC	12 A	With manual operation	858-328
		230 VAC	11 mA	250 VAC	12 A	With manual operation	858-528
<b>Relay Module; 4 changeover contacts; installation width: 31 mm</b>							
		12 VDC	75 mA	250 VAC	5 A	With manual operation	858-303
		24 VDC	36.9 mA	250 VAC	5 A	With manual operation	858-304
		24 VDC	36.9 mA	250 VAC	5 A	Manual operation; with gold contacts	858-314
		24 VDC	42 mA	250 VAC	5 A	With manual operation; for railway applications	858-354
		24 VDC	42 mA	250 VAC	5 A	With manual operation; with gold contacts; for railway applications	858-355
		48 VDC	18.5 mA	250 VAC	5 A	With manual operation	858-305
		110 VDC	10 mA	250 VAC	5 A	With manual operation	858-307
		220 VDC	4.1 mA	250 VAC	5 A	With manual operation	858-308
		24 VAC	50 mA	250 VAC	5 A	With manual operation	858-504
		24 VAC	50 mA	250 VAC	5 A	Manual operation; with gold contacts	858-514
		115 VAC	10 mA	250 VAC	5 A	With manual operation	858-507
		115 VAC	10 mA	250 VAC	5 A	Manual operation; with gold contacts	858-517
		230 VAC	8.3 mA	250 VAC	5 A	With manual operation	858-508
		230 VAC	8.3 mA	250 VAC	5 A	Manual operation; with gold contacts	858-518
		24 VDC	31.5 mA	250 VAC	6 A	With manual operation	858-390
		110 VDC	7.7 mA	250 VAC	6 A	With manual operation	858-392
		220 VDC	4.3 mA	250 VAC	6 A	With manual operation	858-391

<b>Accessories</b>						
Illustration	Description	Nominal Input Voltage	Switching Voltage, Max.	Lim. Continuous Current	Item No.	PU
	Socket for Miniature Switching Relay; 2 and 4 changeover contacts	Depends on relay; max. 250 VAC	250 VAC	4 x 6 A (4 changeover contacts); 2 x 12 A (2 changeover contacts)	858-100	10
	Pluggable Industrial Relay; 4 changeover contacts	24 VDC	250 VAC	5 A	858-150	3
		230 VAC			858-151	3
		24 VAC			858-154	3
	Pluggable Industrial Relay; with gold contacts	24 VDC	250 VAC	5 A	858-152	3
		230 VAC			858-153	3
	Push-in Type Jumper Bar; I <sub>n</sub> 12 A; for commoning one potential on the control and load side				858-402	25
	Holding Bracket for Industrial Relay; height: 33.5 ... 35.5 mm				858-110	10

8

Marking: WMB/Marking Strips      Suitable operating tool: 210-719

# WAGO Relay Modules – 2042 Series

## Pluggable on carrier terminal blocks

Illustration	Circuit Diagram	Nominal Input Voltage	Nominal Input Current	Switching Voltage, Max.	Limiting Continuous Current	Specialty Function	Item No.
<b>Relay Module; 1 make contacts; installation width: 10.3 mm; pluggable for TOPJOB® S carrier terminal block</b>							
		24 VDC	6.6 mA	250 VAC	6 A	For railway applications	2042-3004
		24 ... 230 VAC/DC	26.3 ... 1.7 mA	250 VAC	3 A	For railway applications	2042-3809
<b>Relay Module; 1 break contact; installation width: 10.3 mm; pluggable for TOPJOB® S carrier terminal block</b>							
		24 VDC	6.4 mA	250 VAC	6 A	For railway applications	2042-3054
		24 ... 230 VAC/DC	26.3 ... 1.7 mA	250 VAC	6 A	For railway applications	2042-3859
<b>Relay Module; 1 changeover contacts; installation width: 15.5 mm; pluggable for TOPJOB® S carrier terminal block</b>							
		24 VDC	13.7 mA	250 VAC	10 A	For railway applications	2042-3034
		24 ... 230 VAC/DC	50.2 ... 2.8 mA	250 VAC	4 A	For railway applications	2042-3839
<b>Relay Module; 2 make contacts; installation width: 20.7 mm; pluggable for TOPJOB® S carrier terminal block</b>							
		24 VDC	13.8 mA	250 VAC	8 A	For railway applications	2042-3014
		24 ... 230 VAC/DC	49.1 ... 2.9 mA	250 VAC	5 A	For railway applications	2042-3819
<b>Relay Module; 2 changeover contacts; installation width: 20.7 mm; pluggable for TOPJOB® S carrier terminal block</b>							
		24 VDC	13.8 mA	250 VAC	8 A	For railway applications	2042-3044
		24 ... 230 VAC/DC	49.1 ... 2.9 mA	250 VAC	5 A	For railway applications	2042-3849
<b>Relay Module; 1 break contact and 1 make contact; installation width: 20.7 mm; pluggable for TOPJOB® S carrier terminal block</b>							
		24 VDC	13.8 mA	250 VAC	8 A	For railway applications	2042-3064
		24 ... 230 VAC/DC	49.1 ... 2.9 mA	250 VAC	5 A	For railway applications	2042-3869

8









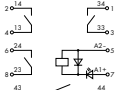

Marking: WMB/Marking Strips

For carrier terminal blocks: see p. 248

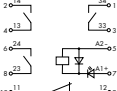

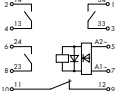
# WAGO Relay Modules – 2042 Series

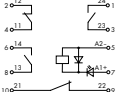
## Pluggable on carrier terminal blocks

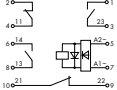
Illustration	Circuit Diagram	Nominal Input Voltage	Nominal Input Current	Switching Voltage, Max.	Limiting Continuous Current	Specialty Function	Item No.
<b>Relay Module; 4 make contacts; installation width: 25.9 mm; pluggable for TOPJOB® S carrier terminal block</b>							
		24 VDC	28.1 mA	250 VAC	5 A	For railway applications	2042-3024
		24 ... 230 VAC/DC	58.4 ... 6 mA	250 VAC	3 A	For railway applications	2042-3829
<b>Relay Module; 3 make contacts and 1 break contact; installation width: 25.9 mm; pluggable for TOPJOB® S carrier terminal block</b>							
		24 VDC	27.4 mA	250 VAC	5 A	For railway applications	2042-3074
		24 ... 230 VAC/DC	58.4 ... 6 mA	250 VAC	3 A	For railway applications	2042-3879
<b>Relay Module; 2 break contact and 2 make contact; installation width: 25.9 mm; pluggable for TOPJOB® S carrier terminal block</b>							
		24 VDC	28.1 mA	250 VAC	5 A	For railway applications	2042-3084
		24 ... 230 VAC/DC	58.4 ... 6 mA	250 VAC	3 A	For railway applications	2042-3889

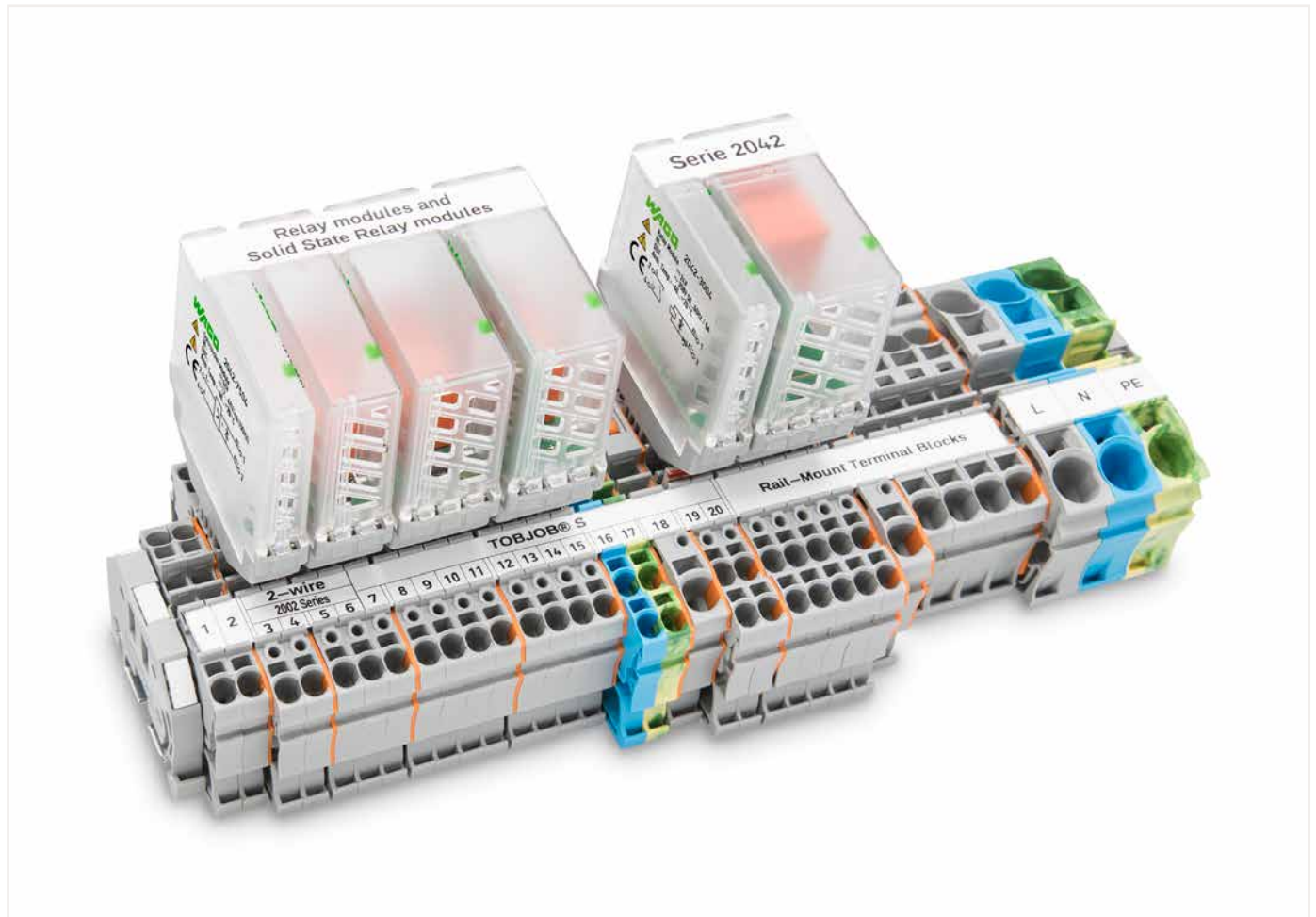

# WAGO Solid-State Relay Modules – 2042 Series

## Carrier Terminal Blocks – 2002 Series

Illustration	Circuit Diagram	Nominal Input Voltage	Nominal Input Current	Output Voltage Range	Limiting Continuous Current	Specialty Function	Item No.
<b>Solid-State Relay Module; 2-wire connection; installation width: 10.3 mm; pluggable for TOPJOB® S carrier terminal block</b>							
		24 VDC (SELV)	7 mA	3 ... 60 VDC	0.1 A	For railway applications	2042-7204
		24 ... 48 VDC (SELV)	3 mA	3 ... 53 VDC	4 A	For railway applications	2042-7504
<b>Solid-State Relay Module; 3-wire connection; installation width: 15.5 mm; pluggable for TOPJOB® S carrier terminal block</b>							
		24 VDC (SELV)	7 mA	20 ... 30 VDC	0.5 A	For railway applications; high-side switching	2042-7304
		24 VDC (SELV)	7 mA	16.8 ... 30 VDC	5 A	For railway applications; high-side switching	2042-7604

<b>Accessories</b>					
Illustration	Description	Color	With Push-Button Item No.	Without Push-Button Item No.	PU
	2-Wire Carrier Terminal Block; for 35 x 15 mm and 35 x 7.5 mm DIN-rails; 2.5 mm <sup>2</sup> ; Push-in CAGE CLAMP®	○ Gray	2202-1661	2002-1661	50
	End and Intermediate Plate; 1 mm thick	● Orange	2002-1692	2002-1692	25
		○ Gray	2002-1691	2002-1691	25
	3-Wire Carrier Terminal Block; for 35 x 15 mm and 35 x 7.5 mm DIN-rails; 2.5 mm <sup>2</sup> ; Push-in CAGE CLAMP®	○ Gray	2202-1761	2002-1761	50
	End and Intermediate Plate; 1 mm thick	● Orange	2002-1792	2002-1792	25
		○ Gray	2002-1791	2002-1791	25
	4-Wire Carrier Terminal Block; for 35 x 15 mm and 35 x 7.5 mm DIN-rails; 2.5 mm <sup>2</sup> ; Push-in CAGE CLAMP®	○ Gray	2202-1861	2002-1861	50
	End and Intermediate Plate; 1 mm thick	● Orange	2002-1892	2002-1892	25
		○ Gray	2002-1891	2002-1891	25
	2-Wire Carrier Terminal Block; with additional commoning with adjacent jumper; for 35 x 15 mm and 35 x 7.5 mm DIN-rails; 2.5 mm <sup>2</sup> ; Push-in CAGE CLAMP®	○ Gray	2202-1961	2002-1961	50
	End and Intermediate Plate; 1 mm thick	● Orange	2002-1992	2002-1992	25
		○ Gray	2002-1991	2002-1991	25

For additional accessories for carrier terminal blocks: see p. 36 ... 38

# WAGO Relay Modules – 789 Series

Illustration	Circuit Diagram	Nominal Input Voltage	Nominal Input Current	Max. Switching Voltage	Limiting Continuous Current	Specialty Function	Item No.
<b>Relay Module; 1 changeover contacts; installation width: 18 mm</b>							
		24 VDC	19 mA	250 VAC	12 A		789-304
		230 VAC	4.2 mA	250 VAC	12 A		789-508
		24 VDC	17 mA	250 VAC	12 A	With manual operation	789-1341
		230 VAC	3.5 mA	250 VAC	12 A	With manual operation	789-1544
		24 VDC	19 mA	250 VAC	12 A	For lamp loads; manual/off/auto switch	789-326
		24 VDC	19 mA	250 VAC	12 A	For lamp loads; manual/off/auto switch	789-329
<b>Relay Module; 1 make contact; installation width: 18 mm</b>							
		24 VAC/DC	32 mA	250 VAC	16 A	For lamp loads	789-520
		24 VDC	19 mA	250 VAC	16 A	For lamp loads; manual/off/auto switch	789-323
		24 VDC	17 mA	250 VAC	16 A	For lamp loads; manual/off/auto switch	789-324
		24 VDC	19 mA	250 VAC	16 A	For lamp loads; manual/off/auto switch	789-325
<b>Relay Module; 2 changeover contacts; installation width: 18 mm</b>							
		24 VDC	21 mA	250 VAC	8 A		789-312
		24 VDC	17 mA	250 VAC	8 A	With manual operation	789-1346
		230 VAC	3.5 mA	250 VAC	8 A	With manual operation	789-1549
<b>Relay Module; 2 make contacts and 2 break contacts; installation width: 18 mm</b>							
		24 VAC/DC	12 mA	250 VAC	4 A		789-536
<b>Relay Module; 4 make contact; installation width: 18 mm</b>							
		24 VAC/DC	12 mA	250 VAC	4 A		789-552

# WAGO Relay Modules – 288 Series

Illustration	Circuit Diagram	Nominal Input Voltage	Nominal Input Current	Max. Switching Voltage	Limiting Continuous Current	Specialty Function	Item No.
<b>Relay Module; 1 make contact; installation width: 13 mm</b>							
		24 VDC	20 mA	250 VAC	5 A		288-364
		24 VAC/DC	20 ma	250 VAC	5 A		288-564
<b>Relay Module; 1 break contact; installation width: 13 mm</b>							
		24 VDC	20 mA	250 VAC	5 A		288-368
<b>Relay Module; 1 changeover contacts; installation width: 21 mm</b>							
		24 VDC	21.8 mA	250 VAC	6 A		288-304
		24 VAC/DC	21.8 mA	250 VAC	6 A		288-504
		24 VDC	41.5 mA	250 VAC	6 A	Bistable	288-380
<b>Relay Module; 2 changeover contacts; installation width: 23 mm</b>							
		24 VDC	21.8 mA	250 VAC	6 A		288-312
		24 VAC/DC	21.8 mA	250 VAC	6 A		288-512
<b>Relay Module; 2 changeover contacts; installation width: 19 mm</b>							
		24 VDC	36 mA	250 VAC	5 A	With force-guided contacts	288-437
<b>Relay Module; 4 make contacts and 4 break contacts; installation width: 64 mm</b>							
		12 VAC/DC	41.6 mA	250 VAC	6 A	With force-guided contacts	288-413
		24 VAC/DC	26 mA	250 VAC	6 A	With force-guided contacts	288-414
		230 VAC/VDC	10 mA	250 VAC	6 A	With force-guided contacts	288-418

8

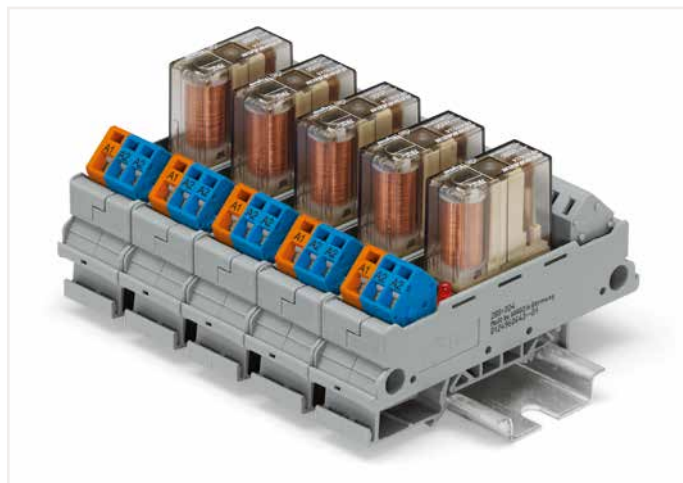

For WAGO relay modules, optocoupler modules and additional 286 Series electronic modules, see [www.wago.com](http://www.wago.com).

# WAGO Relay Modules

## Technical Information

### Contact material

For contact reliability, the contact resistance over the relay's entire operating life should remain relatively low and constant. A variety of contact materials can be selected depending on the load type, switching current, switching voltage and desired number of switching cycles. The accompanying table shows the materials with the typical features and application notes that are used for the WAGO relay modules.

Contact Material	Properties and Applications	Application Range
AgNi 0.15 + Au	Excellent corrosion resistance, low and constant contact resistance values at extremely low switching power; for dry circuits	$\mu\text{V} \dots 30 \text{ V}$ $\mu\text{A} \dots 0.2 \text{ A}$
AgNi 0.15	Good mechanical stability, low welding tendency and low contact resistance, universal use at moderate loads	$\geq 12 \text{ V}$ $5 \text{ mA} \dots 10 \text{ A}$
AgSnO <sub>2</sub>	Low welding tendency, extremely high burn-off resistance at high switching power; suitable for circuits with high switch-on/off loads, DC circuits	$\geq 5 \text{ V} / 100 \text{ mA}$ $\geq 10 \text{ V} / 10 \text{ mA}$ $\geq 24 \text{ V} / 1 \text{ mA}$

### Contact Protective Circuit

When switching off inductive loads, such as contactors and solenoid valves, transients occur with peak voltages up to several thousand volts. These transients often exceed the permissible EMC standard limits and must therefore be limited by external circuits. They also cause an electric arc at the switching contact, which can destroy the contact or significantly diminish the relay's service life and reliability. The following protective circuits, which are outlined in the table, are connected directly to the source in parallel to the load and have proven successful.

### Service Life

A distinction must be made between the mechanical service life, which indicates the number of switching cycles without contact load. The electrical service life at maximum load indicates the number of switching cycles with maximum switching power and resistive load. Reduced power increases the service life compared to the value of the maximum load. The following figure shows the typical curve between relating the switching current and service life of a relay.

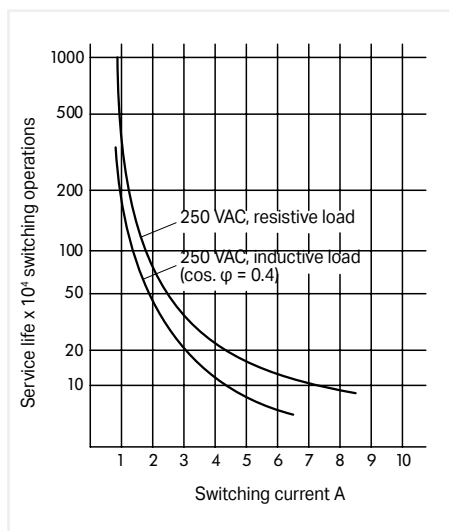



Load Circuit	Additional Fall Delay	Defined Induction Voltage Limitation	Bipolar-Effective Attenuation	Advantages:	Disadvantages:
<b>Diode</b> 	Large	Yes ( $U_D$ )	No	<ul style="list-style-type: none"> <li>Easy implementation</li> <li>Cost-effective, reliable</li> <li>Dimensioning not critical</li> <li>Small induction voltages</li> </ul>	<ul style="list-style-type: none"> <li>Attenuation only via load resistor</li> </ul>
<b>Diode/Zener Diode Series Circuit</b> 	Medium to small	Yes ( $U_{ZD}$ )	No	<ul style="list-style-type: none"> <li>Dimensioning not critical</li> </ul>	<ul style="list-style-type: none"> <li>Attenuation only above <math>U_{ZD}</math></li> </ul>
<b>Suppressor Diode</b> 	Medium to small	Yes ( $U_{ZD}$ )	Yes	<ul style="list-style-type: none"> <li>High energy absorption</li> <li>Dimensioning not critical</li> <li>Suitable for AC voltage</li> </ul>	<ul style="list-style-type: none"> <li>Attenuation only above <math>U_{VDR}</math></li> </ul>
<b>Varistor</b> 	Medium to small	Yes ( $U_{VDR}$ )	Yes	<ul style="list-style-type: none"> <li>High energy absorption</li> <li>Dimensioning not critical</li> <li>Suitable for AC voltage</li> </ul>	<ul style="list-style-type: none"> <li>Attenuation only above <math>U_{VDR}</math></li> </ul>
<b>R/C Combination</b> 	Medium to small	No	Yes	<ul style="list-style-type: none"> <li>RF attenuation via power storage</li> <li>Suitable for AC voltage</li> <li>Level-independent attenuation</li> </ul>	<ul style="list-style-type: none"> <li>Accurate dimensioning required</li> <li>High inrush current</li> </ul>

# WAGO Energy Meters (MID) – 879 Series

## With Push-in CAGE CLAMP® and Levers

Comprehensive energy measurement is necessary for optimizing energy consumption. WAGO energy meters offer numerous advantages. All devices have both an M-Bus and a Modbus® interface for users to select from. In addition, two S0 interfaces are available for both energy directions, with the pulse rate adjustable. Configuration and operation of the new meters are refreshingly straightforward:

A large display facilitates operation using the integrated touch-sensitive controls. A configuration app can also be used that communicates with the device via *Bluetooth*®. With these new energy measurement devices, a wide variety of building and industrial applications can be implemented thanks to the MID declaration of conformity. Applications with consumption billing are also possible.

Item No. 879-3000	Item No. 879-3020	Item No. 879-3040																																																																																																																				
Energy Meter; direct connection (4PU)	Energy Meter; direct connection (4PS)	Energy Meter; transformer connection (2PCT)																																																																																																																				
																																																																																																																						
<table border="1"> <tr><td>9   + (M-bus)</td><td></td></tr> <tr><td>8   B/- (RS485)</td><td></td></tr> <tr><td>7   A (RS485)</td><td></td></tr> <tr><td>6   SO2</td><td></td></tr> <tr><td>5   GND</td><td></td></tr> <tr><td>4   SO1</td><td></td></tr> <tr><td colspan="2"> </td></tr> <tr><td>11   Tariff 230 V~</td><td>L3 OUT</td></tr> <tr><td colspan="2"> </td></tr> <tr><td>10   Tariff 230 V~</td><td>L3 IN</td></tr> <tr><td colspan="2"> </td></tr> <tr><td>N</td><td>L2 OUT</td></tr> <tr><td colspan="2"> </td></tr> <tr><td></td><td>L2 IN</td></tr> <tr><td colspan="2"> </td></tr> <tr><td></td><td>L1 OUT</td></tr> <tr><td colspan="2"> </td></tr> <tr><td></td><td>L1 IN</td></tr> </table>	9   + (M-bus)		8   B/- (RS485)		7   A (RS485)		6   SO2		5   GND		4   SO1				11   Tariff 230 V~	L3 OUT			10   Tariff 230 V~	L3 IN			N	L2 OUT				L2 IN				L1 OUT				L1 IN	<table border="1"> <tr><td>9   + (M-bus)</td><td></td><td>11   Tariff 230 V~</td></tr> <tr><td>8   B/- (RS485)</td><td></td><td></td></tr> <tr><td>7   A (RS485)</td><td></td><td>10   Tariff 230 V~</td></tr> <tr><td>6   SO2</td><td></td><td></td></tr> <tr><td>5   GND</td><td></td><td></td></tr> <tr><td>4   SO1</td><td></td><td></td></tr> <tr><td colspan="3"> </td></tr> <tr><td>L3 OUT</td><td></td><td>L3 IN</td></tr> <tr><td colspan="3"> </td></tr> <tr><td>L2 OUT</td><td></td><td>L2 IN</td></tr> <tr><td colspan="3"> </td></tr> <tr><td>L1 OUT</td><td></td><td>L1 IN</td></tr> </table>	9   + (M-bus)		11   Tariff 230 V~	8   B/- (RS485)			7   A (RS485)		10   Tariff 230 V~	6   SO2			5   GND			4   SO1						L3 OUT		L3 IN				L2 OUT		L2 IN				L1 OUT		L1 IN	<table border="1"> <tr><td>11   Tariff 230 V~</td><td>9   + (M-bus)</td><td></td><td>CT3 OUT</td></tr> <tr><td></td><td></td><td></td><td></td></tr> <tr><td>10   Tariff 230 V~</td><td>8   B/- (RS485)</td><td></td><td>CT3 IN</td></tr> <tr><td></td><td></td><td></td><td></td></tr> <tr><td>N</td><td>7   A (RS485)</td><td></td><td>CT2 OUT</td></tr> <tr><td></td><td></td><td></td><td></td></tr> <tr><td>U3</td><td>6   SO2</td><td></td><td>CT2 IN</td></tr> <tr><td></td><td></td><td></td><td></td></tr> <tr><td>U2</td><td>5   GND</td><td></td><td>CT1 OUT</td></tr> <tr><td></td><td></td><td></td><td></td></tr> <tr><td>U1</td><td>4   SO1</td><td></td><td>CT1 IN</td></tr> </table>	11   Tariff 230 V~	9   + (M-bus)		CT3 OUT					10   Tariff 230 V~	8   B/- (RS485)		CT3 IN					N	7   A (RS485)		CT2 OUT					U3	6   SO2		CT2 IN					U2	5   GND		CT1 OUT					U1	4   SO1		CT1 IN
9   + (M-bus)																																																																																																																						
8   B/- (RS485)																																																																																																																						
7   A (RS485)																																																																																																																						
6   SO2																																																																																																																						
5   GND																																																																																																																						
4   SO1																																																																																																																						
11   Tariff 230 V~	L3 OUT																																																																																																																					
10   Tariff 230 V~	L3 IN																																																																																																																					
N	L2 OUT																																																																																																																					
	L2 IN																																																																																																																					
	L1 OUT																																																																																																																					
	L1 IN																																																																																																																					
9   + (M-bus)		11   Tariff 230 V~																																																																																																																				
8   B/- (RS485)																																																																																																																						
7   A (RS485)		10   Tariff 230 V~																																																																																																																				
6   SO2																																																																																																																						
5   GND																																																																																																																						
4   SO1																																																																																																																						
L3 OUT		L3 IN																																																																																																																				
L2 OUT		L2 IN																																																																																																																				
L1 OUT		L1 IN																																																																																																																				
11   Tariff 230 V~	9   + (M-bus)		CT3 OUT																																																																																																																			
10   Tariff 230 V~	8   B/- (RS485)		CT3 IN																																																																																																																			
N	7   A (RS485)		CT2 OUT																																																																																																																			
U3	6   SO2		CT2 IN																																																																																																																			
U2	5   GND		CT1 OUT																																																																																																																			
U1	4   SO1		CT1 IN																																																																																																																			
Direct measurement up to 65 A		Measurement via current transformer 1 A or 5 A																																																																																																																				
Measurement in two-wire, three-wire and four-wire networks (3 x 230 V/ 400 V)																																																																																																																						
Configuration via touch-sensitive controls on the display and <i>Bluetooth</i> ®																																																																																																																						
Interfaces: Modbus®, M-Bus, S0 pulse output, <i>Bluetooth</i> ®																																																																																																																						
External rate control input (230 V)																																																																																																																						
4-quadrant measurement																																																																																																																						
Illuminated displays: voltage (V), current (A), frequency (Hz), active power (kW), reactive power (kvarh), apparent power (kVA)																																																																																																																						
Connection technology with Push-in CAGE-CLAMP® and lever																																																																																																																						
Width: 72 mm	Width: 72 mm	Width: 35 mm																																																																																																																				

8

### Your Benefits:

- Communication via M-Bus and Modbus® interfaces and S0 pulses with adjustable pulse rate
- Save valuable space in the distribution box/control cabinet
- Convenient, time-saving installation thanks to Push-in CAGE CLAMP® with lever
- Intuitive configuration through touch-sensitive controls and configuration app via *Bluetooth*®
- All energy quality characteristics on an illuminated full-format display

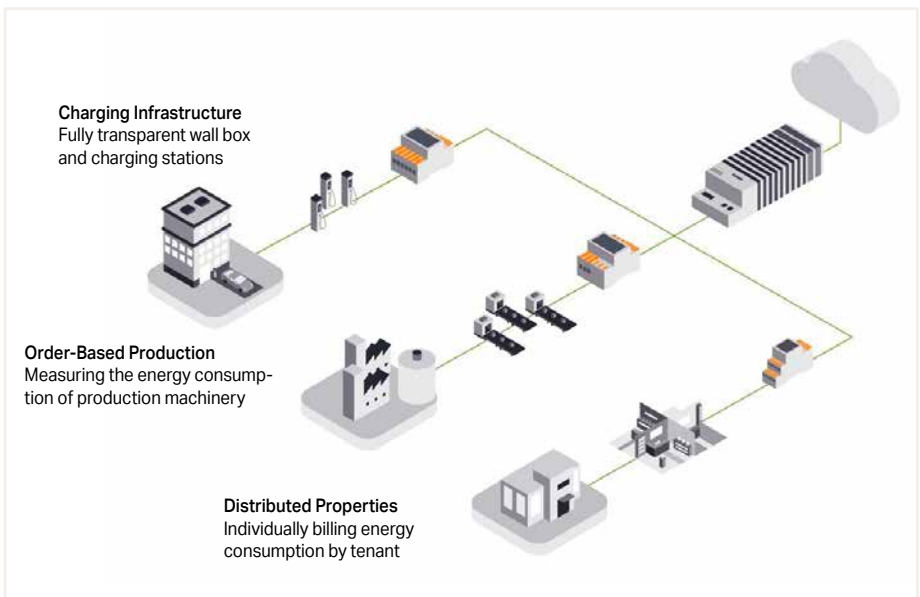

Compatible plug-in current transformer for billing purposes on page 258

# WAGO Ground Resistance Signaling Module – 789 Series



X1.1	Iso OK	⏏	X2.1	
X1.2				
X1.3	+24 V	U <sub>S</sub> +	0 V	X2.2

**Short description:**

This module signals a value falling below a non-adjustable, asymmetric isolation resistance between +24 V or 0 V of the supply voltage and ground with a potential-free (Iso OK) contact and status LED.

**Features:**

- Grounded or ungrounded control circuit mode can be selected via slide switch
- Iso OK is indicated via potential-free optocoupler contact and LEDs
- Response time: max. 10 s

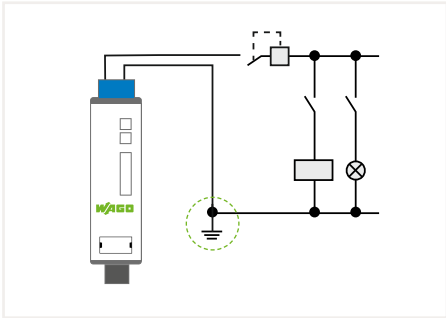

**The IEC 60204-1 standard states:**

Measures must be taken to reduce the probability of malfunctions due to insulation faults/ground faults in a control circuit. This includes initiating potentially dangerous movements unintentionally or purposely stopping the machine.

**Simple wire for grounding 0 V as the usual solution**

- Immediate triggering of the fuse in the event of a low-resistance ground fault
- Instant system shutdown
- No pre-warning

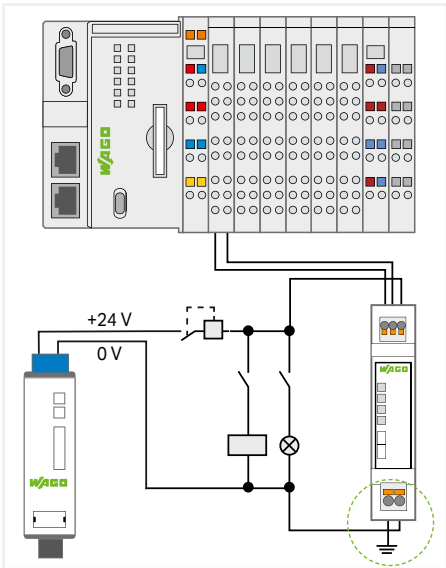

**Ground resistance signaling module – automatic insulation resistance test**

The ground resistance signaling module offers the industry's best cost-benefit ratio and is easy to use. The existing ground conductor disconnect terminal block can easily be replaced. Only two additional wires have to be connected to the PLC to make the potential-free contact ready for evaluation.



Isolation OK

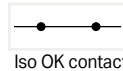

Iso OK contact



Ground fault +24 V

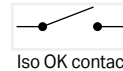

Iso OK contact



Ground fault 0 V

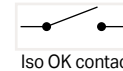

Iso OK contact

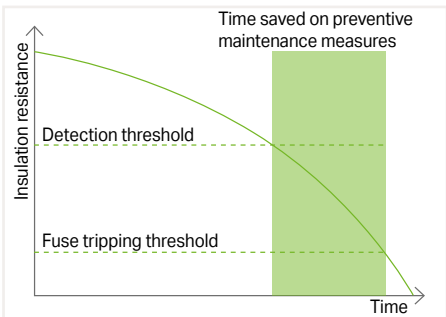

**Note the boundary conditions for using our ground resistance signaling module:**

- Ground fault must be asymmetrical
- Control circuit supply must be switched on
- In "grounded control circuit" mode, the connection between 0 V and ground is broken during the measurement
- Iso OK contact must not be used to trigger safety devices
- The IEC 61557-8 standard for insulation monitors is not met

Description	Item No.
Ground Resistance Signaling Module; Iso OK contact: supply voltage: 24 VDC; installation width: 18 mm	789-665

Technical Data	
Nominal supply voltage U <sub>s</sub>	24 VDC (SELV)
Supply voltage range	-25 ... +30 %
Power consumption at nominal supply voltage	≤ 40 mA
Power loss P <sub>I</sub>	≤ 1.7 W
Switching voltage, max. (Iso OK contact)	48 VDC (SELV)
Continuous current, max. (Iso OK contact)	500 mA (for general use)
Response value for alarm at nominal voltage	4 kΩ (±1 kΩ)
Hysteresis, typ.	1 kΩ
Response time (grounded control circuit)	10 s
Response time (ungrounded control circuit)	1 s
Measurement time window	≤ 500 ms
Width	18 mm
Height from upper edge of DIN-rail	51 mm
Depth	90 mm
Surrounding air temperature (operation)	-40 ... +70 °C
Relative humidity	5 ... 95 % (non-condensing)
Operating altitude, max.	3000 m

# WAGO Overvoltage Protection – 792 Series

Illustration	Circuit Diagram	Nominal Voltage	Nominal Current	Discharge Current, Max.	Protection Level, Cat. C3 at $I_N$	Maximum Continuous Operating Voltage	Item No.
Surge Protection Module for Signal Technology; for 2 signal paths with common surge arrester; for asymmetric interfaces; 2-stage; installation width: 6 mm							
		24 VDC	0.5 A	10 kA	$\leq 90$ V (line/line); $\leq 45$ V (line/protected ground)	23 VAC / 33 VDC	792-800
Surge Protection Module for Signal Technology; for 2 signal paths with common surge arrester; for symmetric interfaces; 2-stage; installation width: 6 mm							
		24 VDC	0.5 A	10 kA	$\leq 45$ V (line/line); $\leq 650$ V (line/protected ground)	23 VAC / 33 VDC	792-801
Surge Protection Module for Signal Technology; for 2 signal paths with common surge arrester; for supply lines; 1-stage; installation width: 6 mm							
		24 VDC	10 A	5 kA	$\leq 45$ V (line/line); $\leq 650$ V (line/protected ground)	23 VAC / 33 VDC	792-802
Surge Protection Module for Signal Technology; for 2 signal paths with common surge arrester; for symmetric interfaces; for protection of intrinsically safe circuits; 2-stage; installation width: 6 mm							
		24 VDC	0.5 A	10 kA	$\leq 45$ V (line/line); $\leq 1.4$ kV (line/protected ground)	23 VAC / 33 VDC	792-803
Surge Protection Module for Signal Technology; for 2 signal paths with common surge arrester; for symmetric interfaces; 2-stage; installation width: 6 mm							
		48 VDC	1.7 A	10 kA	$\leq 79$ V (line/line); $\leq 650$ V (line/protected ground)	38.5 VAC / 55 VDC	792-804
Surge Protection Module for Signal Technology; for 2 signal paths with common surge arrester; for interfaces with high data rates; 2-stage; installation width: 6 mm							
		5 VDC	0.1 A	10 kA	$\leq 14$ V (line/line); $\leq 14$ V (line/protected ground)	4.2 VAC / 6 VDC	792-805



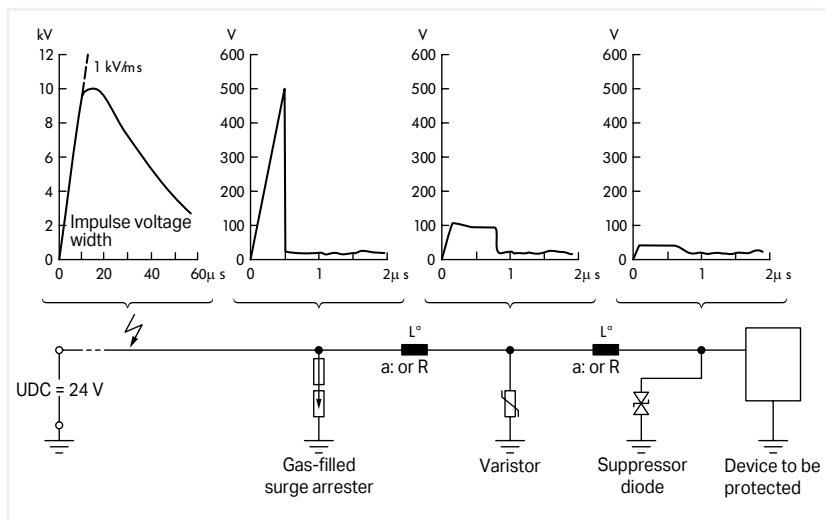





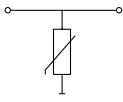

Accessories							
Illustration	Circuit Diagram	Description	Item No.	PU			
		End and Intermediate Plate; 1 mm thick; gray	859-525	25			
		Push-in Type Jumper Bar; light gray; insulated; $I_N$ 18 A					
		2-way	859-402	25			
		⋮	⋮				
		10-way	859-410	25			

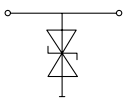

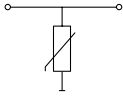
Function diagram of a multi-stage surge protection module

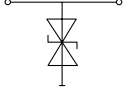
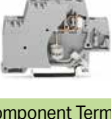
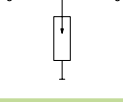
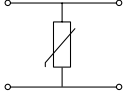

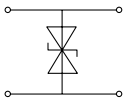











## WAGO Overvoltage Protection – 280 Series

Illustration	Circuit Diagram	Operating Voltage	Nominal Discharge Current	Protection Level (8/20 $\mu$ s)	Maximum Continuous Operating Voltage	Item No.	Pack. Unit
<b>Component Terminal Block with Varistor; with direct connection to DIN-rail; installation width: 5 mm</b>							
		24 VDC	60 A	$\leq 77$ VDC	31 VDC	280-502/281-609	50
		48 VDC	300 A	$\leq 135$ VDC	65 VDC	280-502/281-610	50
		60 VDC	300 A	$\leq 165$ VDC	85 VDC	280-502/281-611	50
		110 VDC	300 A	$\leq 300$ VDC	150 VDC	280-502/281-612	50
		24 VAC	60 A	$\leq 93$ VAC	30 VAC	280-502/281-613	50
		115 VAC	300 A	$\leq 360$ VAC	140 VAC	280-502/281-614	50
<b>Component Terminal Block with Transil Diode; with direct connection to DIN-rail; installation width: 5 mm</b>							
		24 VDC	12 A	$\leq 50$ VDC	30.8 VDC	280-502/281-602	50
		48 VDC	6.5 A	$\leq 92$ VDC	58 VDC	280-502/281-603	50
		60 VDC	4.8 A	$\leq 125$ VDC	77 VDC	280-502/281-604	50
		110 VDC	2.7 A	$\leq 219$ VDC	136 VDC	280-502/281-605	50
		24 VAC	9.3 A	$\leq 65$ VAC	28 VAC	280-502/281-606	50
		115 VAC	1.7 A	$\leq 384$ VAC	133 VAC	280-502/281-607	50
<b>Component Terminal Block with Varistor and end and intermediate plate; with direct connection to DIN-rail; installation width: 10 mm</b>							
		24 VDC	300 A	$\leq 77$ VDC	31 VDC	280-502/281-582	25
		48 VDC	300 A	$\leq 135$ VDC	56 VDC	280-502/281-583	25
		60 VDC	1000 A	$\leq 165$ VDC	85 VDC	280-502/281-584	25
		110 VDC	1000 A	$\leq 300$ VDC	150 VDC	280-502/281-585	25
		24 VAC	1000 A	$\leq 93$ VAC	30 VAC	280-502/281-586	25
		115 VAC	300 A	$\leq 395$ VAC	150 VAC	280-502/281-587	25
<b>Component Terminal Block with Transil Diode and End and Intermediate Plate; with direct connection to DIN-rail; installation width: 10 mm</b>							
		24 VDC	169 A	$\leq 59$ VDC	28 VDC	280-502/281-589	25
		48 VDC	90 A	$\leq 111$ VDC	52 VDC	280-502/281-590	25
		60 VDC	69 A	$\leq 146$ VDC	70 VDC	280-502/281-591	25
		110 VDC	38 A	$\leq 265$ VDC	128 VDC	280-502/281-592	25
		24 VAC	143 A	$\leq 70$ VAC	26 VAC	280-502/281-593	25
		115 VAC	26 A	$\leq 388$ VAC	133 VAC	280-502/281-594	25
<b>Component Terminal Block with Gas-filled Surge Arrester and End and Intermediate Plate; with direct connection to DIN-rail; installation width: 10 mm</b>							
		24 VAC/DC	5000 A	$\leq 600$ VAC	80 VAC / 90 VDC	280-503/281-579	25
		115 VAC/VDC	5000 A	$\leq 650$ VAC	180 VAC / 230 VDC	280-503/281-580	25
		230 VAC/VDC	5000 A	$\leq 1100$ VAC	450 VAC / 600 VDC	280-503/281-581	25
<b>Component Terminal Block with Varistor and End and Intermediate Plate; installation width: 10 mm</b>							
		24 VDC	300 A	$\leq 77$ VDC	31 VDC	280-504/281-582	25
		48 VDC	300 A	$\leq 135$ VDC	56 VDC	280-504/281-583	25
		60 VDC	1000 A	$\leq 165$ VDC	85 VDC	280-504/281-584	25
		110 VDC	1000 A	$\leq 300$ VDC	150 VDC	280-504/281-585	25
		24 VAC	300 A	$\leq 93$ VAC	30 VAC	280-504/281-586	25
		115 VAC	1000 A	$\leq 395$ VAC	150 VAC	280-504/281-587	25
<b>Component Terminal Block with Transil Diode and End and Intermediate Plate; installation width: 10 mm</b>							
		24 VDC	169 A	$\leq 59$ VDC	28 VDC	280-944/281-589	25
		48 VDC	90 A	$\leq 111$ VDC	53 VDC	280-944/281-590	25
		60 VDC	69 A	$\leq 146$ VDC	70 VDC	280-944/281-591	25
		110 VDC	38 A	$\leq 265$ VDC	128 VDC	280-944/281-592	25
		24 VAC	143 A	$\leq 70$ VAC	26 VAC	280-944/281-593	25
		115 VAC	26 A	$\leq 388$ VAC	133 VAC	280-944/281-594	25
<b>Accessories</b>							
	End and Intermediate Plate; 2.5 mm thick						
	● Orange						280-341
○ Gray						280-340	25

# WAGO Current Transformers – 855 Series

## Selection Guide

						
Current Transformers; 855 Series	Split-Core Current Transformers	Plug-In Current Transformers with CAGE CLAMP® Connection Technology	Plug-In Current Transformers with <i>picoMAX</i> ® Connection Technology	Current and Voltage Tap	RC 70 / RC 125 / RC 175 Rogowski Coil	
Application	Retrofitting	New systems	New systems	New systems	Retrofitting	
Coil bobbin	Separable	Closed	Closed	Closed	Bayonet connector, separable	
Connection technology	Connection cable (color coded)	CAGE CLAMP®	<i>picoMAX</i> ®	Push-in CAGE CLAMP®	Connection cable	
Mounting	Round cable (insulated); Copper bar (insulated)	Round cable; copper current bar; DIN-rail; mounting plate	Round cables; DIN-rail; mounting plate	Jumper slot of the 285 Series 2-Conductor Through Terminal Blocks	Round cable; copper current bar	
Compatibility with other WAGO components	750-493; (750-493/000-001); 750-494; (750-494/000-001); 750-495; (750-495/000-001); 857-550; 2857-570/024-001; 2857-570/024-005		750-493; 750-494; 750-495; 857-550; 2857-570/024-001		750-493; 750-494; 750-495; 857-550; 2857-570/024-001	750-495/000-002; 857-552; 2857-570/024-000
Primary Rated Current	60 ... 1000 A	50 ... 2500 A	32 A	35 A / 64 A	150 ... 350 A	Up to 4000 A
Secondary Rated Current	1 A / 5 A	1 A / 5 A	320 mA	1 A	1 A	22.5 mV/kA
Accuracy Class	0.5 / 1 / 3	1 / 3	0,5	1	0,5	0,5
Surrounding air temperature	-10 ... +55 °C	-5 ... +50 °C	-10 ... +55 °C		-25 ... +70 °C	-40 ... +80 °C
Standards	EN 61869-2	EN 61869-2	EN 61869-2		EN 61869-2; EN 60947-7-3; IEC 60068-2-6	IEC 61010-1; EN 61869-2
Approvals	-		-		-	
Connection examples						

9

# WAGO Terminal Block Assemblies for Transformer Circuits; Line Length Calculation for Current Transformers

Suitable for 1 A (750-493), 5 A (750-493/000-001),  
1 A (750-494), 5 A (750-494/000-001)

Pre-assembled terminal block assembly for easily connecting and short-circuiting current transformers; suitable for 3-phase power measurement modules (750-493 and 750-494)

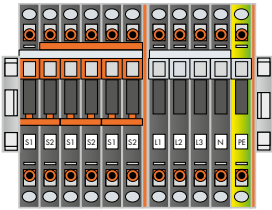

Compact terminal block for current transformer circuit, 2007-8873  
Connection option for current and voltage, including star point jumper

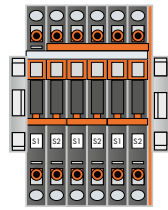

Compact terminal block for current transformer circuit, 2007-8875  
Connection option for current and voltage, including star point jumper

Suitable for 1 A (750-495), 5 A (750-495/000-001),  
1 A (2857-570/024-001), 5 A (2857-570/024-005)

Pre-assembled terminal block assembly for easily connecting and short-circuiting current transformers, suitable for 3-phase power measurement modules (750-495)

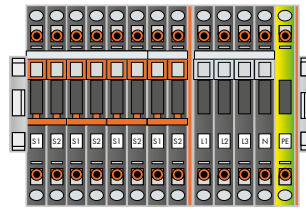

Compact terminal block for current transformer circuit, 2007-8874  
Connection option for current and voltage

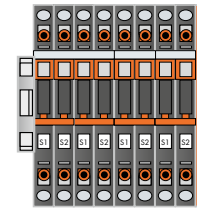

Compact terminal block for current transformer circuit, 2007-8877  
Connection option for current

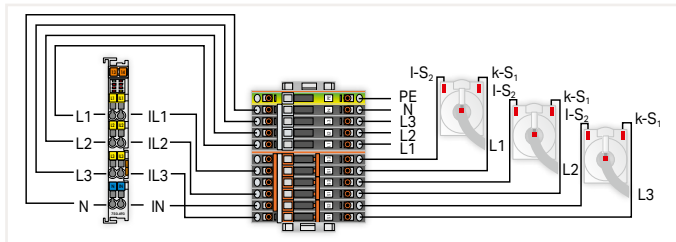

3-Phase Power Measurement Module, 750 Series

Terminal block assembly (2007 series) for current transformers and voltage taps

Current Transformers, 855 Series

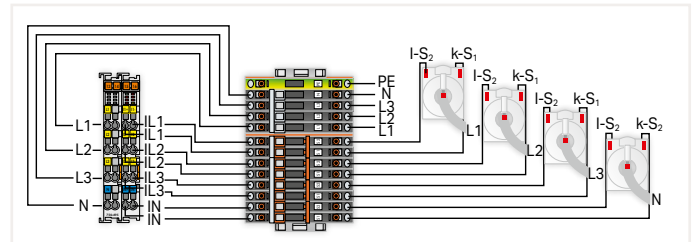

3-Phase Power Measurement Module, 750 Series

Terminal block assembly (2007 series) for current transformers and voltage taps

Current Transformers, 855 Series

## Line length calculation

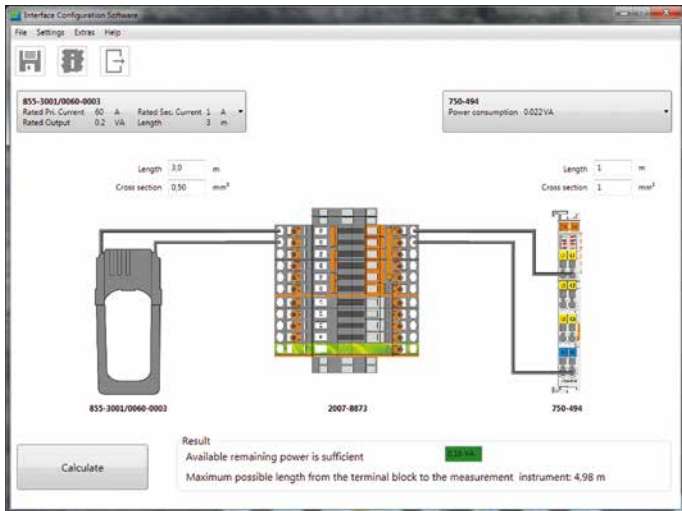

Cable length calculation using the interface configuration software

Power calculation of copper cables between measurement device and current transformer

$$P_V = \frac{I_S^2 \times 2 \times l}{A_{Cu} \times 56} \text{ VA}$$

$I_S$  = secondary rated current strength [A]  
 $l$  = simple cable length in m  
 $A_{Cu}$  = cable cross-section in mm<sup>2</sup>  
 $P_V$  = power loss of connection cables

Note: When a common three-phase return line is used, the values for  $P_V$  are halved!

## Cable length calculator







### Configuration report

Project	WAGO
Project number	1582.23.58877
Company	Wago Kontakttechnik GmbH & Co. KG
Author	Michael Meyer
Date	21.08.2015
Stamp	



<b>Transducer</b>	
Item number	855-3001/0060-0003
Rated Pri. Current	60A
Rated Sec. Current	1A
Rated Output	0,221VA
<b>Measurement instrument</b>	
Item number	750-494
Power consumption	0,022VA
<b>Cable from transducer to terminal block</b>	
Length	3m
Cross section	0.5mm <sup>2</sup>
Power loss	0,021VA
<b>Cable from terminal block to measurement instrument</b>	
Length	1m
Cross section	1mm <sup>2</sup>
Power loss	0,036VA
<b>Result</b>	
Available power	0,221VA
Total power loss	0,057VA
Remaining power	0,164VA
Required power	0,022VA
Result	Available remaining power is sufficient

Easy documentation!

## WAGO Plug-in Current Transformers – 855 Series with CAGE CLAMP® connection

Illustration	Primary Rated Current	Secondary Rated Current	Rated Power	Accuracy Class	Hole for Conductor/Cable	Item No.
<b>Plug-In Current Transformer; with CAGE CLAMP® Connection</b>						
	50 A	1 A	1.25 VA	3	Current bar 1: 30 x 10 mm Current bar 2: 25 x 12 mm Current bar 3: 20 x 20 mm Round cable: 26 mm	855-301/050-103
	50 A	5 A	1.25 VA	3		855-305/050-103
	60 A	1 A	1.25 VA	1		855-301/060-101
	60 A	5 A	1.25 VA	1		855-305/060-101
	75 A	1 A	2.5 VA	1		855-301/075-201
	75 A	5 A	2.5 VA	1		855-305/075-201
	100 A	1 A	2.5 VA	1		855-301/100-201
	100 A	5 A	2.5 VA	1		855-305/100-201
	150 A	1 A	5 VA	1		855-301/150-501
	150 A	5 A	5 VA	1		855-305/150-501
	200 A	1 A	5 VA	1		855-301/200-501
	200 A	5 A	5 VA	1		855-305/200-501
	250 A	1 A	5 VA	1		855-301/250-501
	250 A	5 A	5 VA	1		855-305/250-501
	300 A	5 A	5 VA	1		855-305/300-501
	400 A	1 A	10 VA	1		855-301/400-1001
400 A	5 A	10 VA	1	855-305/400-1001		
600 A	1 A	10 VA	1	855-301/600-1001		
600 A	5 A	10 VA	1	855-305/600-1001		
	250 A	1 A	5 VA	1	Current bar 1: 40 x 10 mm Current bar 2: 30 x 15 mm Round cable: 32 mm	855-401/250-501
	250 A	5 A	5 VA	1		855-405/250-501
	400 A	1 A	5 VA	1		855-401/400-501
	400 A	5 A	5 VA	1		855-405/400-501
	600 A	1 A	5 VA	1		855-401/600-501
	750 A	5 A	5 VA	1		855-405/750-501
	400 A	1 A	10 VA	1	Current bar 1: 50 x 12 mm Current bar 2: 40 x 30 mm Round cable: 44 mm	855-501/400-1001
	400 A	5 A	10 VA	1		855-505/400-1001
	600 A	1 A	10 VA	1		855-501/600-1001
	600 A	5 A	10 VA	1		855-505/600-1001
	800 A	1 A	10 VA	1		855-501/800-1001
	800 A	5 A	10 VA	1		855-505/800-1001
	1000 A	1 A	10 VA	1		855-501/1000-1001
	1000 A	5 A	10 VA	1		855-505/1000-1001
	1500 A	5 A	5 VA	1	Current bar 1: 63 x 10 mm Current bar 2: 50 x 30 mm Round cable: 44 mm	855-605/1500-501
	1500 A	1 A	5 VA	1		855-601/1500-501
	1000 A	1 A	10 VA	1	Current bar 1: 80 x 10 mm Current bar 2: 60 x 30 mm Round cable: 55 mm	855-801/1000-1001
	2000 A	5 A	10 VA	1		855-805/2000-1001
	2000 A	1 A	10 VA	1		855-801/2000-1001
	2500 A	5 A	10 VA	1	Current bar 1: 100 x 10 mm Current bar 2: 80 x 30 mm Round cable: 70 mm	855-1005/2500-1001
	2500 A	1 A	10 VA	1		855-1001/2500-1001

### Plug-In Current Transformer; for Billing Purposes; with CAGE CLAMP® Connection

	100 A	5 A	2.5 VA	0,5	Current bar 1: 30 x 10 mm Current bar 2: 25 x 12 mm Current bar 3: 20 x 20 mm Round cable: 26 mm	855-305/100-209
	150 A	5 A	2.5 VA	0,5		855-305/150-209
	200 A	5 A	5 VA	0,5		855-305/200-509
	250 A	5 A	5 VA	0,5		855-305/250-509
	300 A	5 A	5 VA	0,5		855-305/300-509
	400 A	5 A	5 VA	0,5		855-305/400-509
	500 A	5 A	5 VA	0,5		855-305/500-509
	600 A	5 A	5 VA	0,5		855-305/600-509
	750 A	5 A	5 VA	0,5	Current bar 1: 40 x 10 mm Current bar 2: 30 x 15 mm Round cable: 32 mm	855-305/750-509
	200 A	5 A	2.5 VA	0,5		855-405/200-209
	250 A	5 A	2.5 VA	0,5		855-405/250-209
	300 A	5 A	5 VA	0,5		855-405/300-509
	400 A	5 A	5 VA	0,5		855-405/400-509
	500 A	5 A	5 VA	0,5		855-405/500-509
	600 A	5 A	5 VA	0,5		855-405/600-509
750 A	5 A	5 VA	0,5	855-405/750-509		

### Accessories

Illustration	Description	Item No.
	DIN-Rail Adapter for Plug-in Current Transformers (855-3xx/xxxx-xxxx and 855-4xx/xxxx-xxxx)	855-9900
	Quick-Mount Kit for Plug-in Current Transformers with CAGE CLAMP® Connections	855-9910

## WAGO Split-Core Current Transformers – 855 Series

Illustration	Primary Rated Current	Secondary Rated Current	Rated Power	Accuracy Class	Cable Length	Conductor Cross-Section	Feedthrough for Measurement Conductor	Item No.
<b>Split-Core Current Transformers</b>								
	60 A	1 A	0.2 VA	3	3 m	0.5 mm <sup>2</sup>	Ø 18 mm	855-3001/060-003
	75 A	1 A	0.2 VA	3	3 m	0.5 mm <sup>2</sup>		855-3001/075-003
	100 A	1 A	0.2 VA	3	3 m	0.5 mm <sup>2</sup>		855-3001/100-003
	125 A	1 A	0.2 VA	3	3 m	0.5 mm <sup>2</sup>		855-3001/125-003
	150 A	1 A	0.2 VA	3	3 m	0.5 mm <sup>2</sup>		855-3001/150-003
	200 A	1 A	0.2 VA	1	3 m	0.5 mm <sup>2</sup>		855-3001/200-001
	250 A	1 A	0.2 VA	1	3 m	0.5 mm <sup>2</sup>		855-3001/250-001
	100 A	1 A	0.2 VA	1	3 m	0.5 mm <sup>2</sup>	Ø 18 mm	855-4001/100-001
	125 A	1 A	0.2 VA	1	3 m	0.5 mm <sup>2</sup>		855-4001/125-001
	150 A	1 A	0.2 VA	1	3 m	0.5 mm <sup>2</sup>		855-4001/150-001
	150 A	5 A	1 VA	1	0.5 m	1.5 mm <sup>2</sup>		855-4005/150-101
	200 A	1 A	0.2 VA	0.5	3 m	0.5 mm <sup>2</sup>		855-4001/200-001
	200 A	5 A	1 VA	1	0.5 m	1.5 mm <sup>2</sup>		855-4005/200-101
	250 A	1 A	0.2 VA	0.5	3 m	0.5 mm <sup>2</sup>		855-4001/250-000
	250 A	5 A	1 VA	0.5	0.5 m	1.5 mm <sup>2</sup>		855-4005/250-100
		200 A	1 A	0.2 VA	1	3 m		0.5 mm <sup>2</sup>
250 A		1 A	0.2 VA	1	3 m	0.5 mm <sup>2</sup>	855-4101/250-001	
250 A		5 A	1 VA	1	0.5 m	1.5 mm <sup>2</sup>	855-4105/250-101	
300 A		1 A	0.2 VA	1	3 m	0.5 mm <sup>2</sup>	855-4101/300-101	
300 A		5 A	1 VA	1	0.5 m	1.5 mm <sup>2</sup>	855-4105/300-101	
400 A		1 A	0.2 VA	1	3 m	0.5 mm <sup>2</sup>	855-4101/400-001	
400 A		5 A	1 VA	1	0.5 m	1.5 mm <sup>2</sup>	855-4105/400-101	
500 A		1 A	0.2 VA	0.5	3 m	0.5 mm <sup>2</sup>	855-4101/500-000	
500 A		5 A	1 VA	1	0.5 m	1.5 mm <sup>2</sup>	855-4105/500-101	
		250 A	1 A	0.5 VA	1	5 m	0.5 mm <sup>2</sup>	Ø 42 mm
	300 A	1 A	0.5 VA	1	5 m	0.5 mm <sup>2</sup>	855-5001/300-001	
	300 A	5 A	0.5 VA	1	3 m	1.5 mm <sup>2</sup>	855-5005/300-001	
	400 A	1 A	0.5 VA	0.5	5 m	0.5 mm <sup>2</sup>	855-5001/400-000	
	400 A	5 A	0.5 VA	1	3 m	1.5 mm <sup>2</sup>	855-5005/400-001	
	500 A	1 A	0.5 VA	0.5	5 m	0.5 mm <sup>2</sup>	855-5001/500-000	
	500 A	5 A	0.5 VA	1	3 m	1.5 mm <sup>2</sup>	855-5005/500-001	
	600 A	1 A	0.5 VA	0.5	5 m	0.5 mm <sup>2</sup>	855-5001/600-000	
	600 A	5 A	0.5 VA	0.5	3 m	1.5 mm <sup>2</sup>	855-5005/600-000	
	750 A	1 A	0.5 VA	0.5	5 m	0.5 mm <sup>2</sup>	855-5001/750-000	
	750 A	5 A	0.5 VA	0.5	3 m	1.5 mm <sup>2</sup>	855-5005/750-000	
	800 A	1 A	0.5 VA	0.5	5 m	0.5 mm <sup>2</sup>	855-5001/800-000	
	800 A	5 A	0.5 VA	0.5	3 m	1.5 mm <sup>2</sup>	855-5005/800-000	
	1000 A	1 A	0.5 VA	0.5	5 m	0.5 mm <sup>2</sup>	855-5001/1000-000	
	1000 A	5 A	0.5 VA	0.5	3 m	1.5 mm <sup>2</sup>	855-5005/1000-000	
		250 A	1 A	0.5 VA	1	5 m	0.5 mm <sup>2</sup>	
300 A		1 A	0.5 VA	1	5 m	0.5 mm <sup>2</sup>	855-5101/300-001	
300 A		5 A	0.5 VA	1	3 m	1.5 mm <sup>2</sup>	855-5105/300-001	
400 A		1 A	0.5 VA	0.5	5 m	0.5 mm <sup>2</sup>	855-5101/400-000	
400 A		5 A	0.5 VA	1	3 m	1.5 mm <sup>2</sup>	855-5105/400-001	
500 A		1 A	0.5 VA	0.5	5 m	0.5 mm <sup>2</sup>	855-5101/500-000	
500 A		5 A	0.5 VA	1	3 m	1.5 mm <sup>2</sup>	855-5105/500-001	
600 A		1 A	0.5 VA	0.5	5 m	0.5 mm <sup>2</sup>	855-5101/600-000	
600 A		5 A	0.5 VA	0.5	3 m	1.5 mm <sup>2</sup>	855-5105/600-000	
750 A		1 A	0.5 VA	0.5	5 m	0.5 mm <sup>2</sup>	855-5101/750-000	
750 A		5 A	0.5 VA	0.5	3 m	1.5 mm <sup>2</sup>	855-5105/750-000	
800 A		1 A	0.5 VA	0.5	5 m	0.5 mm <sup>2</sup>	855-5101/800-000	
800 A		5 A	0.5 VA	0.5	3 m	1.5 mm <sup>2</sup>	855-5105/800-000	
1000 A		1 A	0.5 VA	0.5	5 m	0.5 mm <sup>2</sup>	855-5101/1000-000	
1000 A	5 A	0.5 VA	0.5	3 m	1.5 mm <sup>2</sup>	855-5105/1000-000		

9



# WAGO Plug-In Current Transformers with *picoMAX*® Pluggable Connector; WAGO Rogowski Coils – 855 Series

Illustration	Primary Rated Current	Secondary Rated Current	Rated Power	Accuracy Class	Hole for Conductor/Cable	Item No.
<b>Plug-In Current Transformer; with <i>picoMAX</i>® Pluggable Connector</b>						
	35 A	1 A	0.2 VA	1	Ø max. 7.5 mm	855-2701/035-001
	64 A	1 A	0.2 VA	1	Ø max. 7.5 mm	855-2701/064-001

Accessories		
Illustration	Description	Item No.
	DIN-rail adapter for plug-in current transformer	855-9927



Snap the current transformer onto the DIN-rail with the help of the DIN-rail adapter



Alternatively, insert the current transformer directly above the circuit breaker to save space



Push-in termination of solid conductors and fine-stranded conductors with ferrules



Universal connection for fine-stranded conductors



Illustration	Primary Rated Current	Secondary Rated Current	Rated Power	Accuracy Class	Hole for Conductor/Cable	Item No.
<b>Plug-In Current Transformer; with <i>picoMAX</i>® Pluggable Connector</b>						
	32 A	0.32 A	0.01 VA	0,5	Ø max. 5 mm	855-1700/032-000



Mount current transformers in a row



Insert the current transformer directly above the circuit breaker to save space





Push-in termination of solid conductors and fine-stranded conductors with ferrules



Universal connection for fine-stranded conductors

## 9

Illustration	Primary Rated Current	Output Signal	Accuracy Class	Feedthrough for Measurement Conductor	Mutual Inductance M	Cable Length	Item No.
<b>Rogowski Coils</b>							
	4000 A	22.5 mV/kA	0,5	Ø 70 mm	71.98 mH	1.5 m	855-9150/2000-701
	4000 A	22.5 mV/kA	0,5	Ø 70 mm	71.98 mH	4.5 m	855-9450/2000-701
	4000 A	22.5 mV/kA	0,5	Ø 125 mm	72.14 mH	1.5 m	855-9150/2000-1251
	4000 A	22.5 mV/kA	0,5	Ø 125 mm	72.14 mH	4.5 m	855-9450/2000-1251
	4000 A	22.5 mV/kA	0,5	Ø 175 mm	72.31 mH	1.5 m	855-9150/2000-1751
	4000 A	22.5 mV/kA	0,5	Ø 175 mm	72.31 mH	4.5 m	855-9450/2000-1751



Bayonet connector  
Robust and durable



Screw-mount clips  
Quick and easy mounting with cable ties



Lock-out seal  
Greater security via sealable bayonet lock



# WAGO Voltage Taps; WAGO Current and Voltage Taps – 855 Series

Illustration	Color	Feedthrough for Measurement Conductor	Fuse (Voltage Path)	Mounting Type	Item No.
<b>Voltage Tap</b>					
	Black	Ø 3 ... 5 mm	2 A; 450 V; F, 70 kA, 5 x 25 mm	Insulation displacement connection (IDC)	855-8001
	Blue	Ø 3 ... 5 mm	-	Insulation displacement connection (IDC)	855-8002
	Black	Ø 5 ... 7 mm	2 A; 450 V; F, 70 kA, 5 x 25 mm	Insulation displacement connection (IDC)	855-8003
	Blue	Ø 5 ... 7 mm	-	Insulation displacement connection (IDC)	855-8004



Installation on an insulated conductor with IDC connection



Integrated SIBA fuse to protect equipment and conductor

Illustration	Color	Busbar	Fuse (Voltage Path)	Mounting Type	Item No.
<b>Voltage Tap</b>					
	Black		2 A; 450 V; F, 70 kA, 5 x 25 mm	M6 mount	855-8006
	Black		2 A; 450 V; F, 70 kA, 5 x 25 mm	M8 mount	855-8008
	Black	4 ... 15 mm	2 A; 450 V; F, 70 kA, 5 x 25 mm	Clamp mount	855-8015



Installation on busbar; fastening with Allen wrench





Integrated SIBA fuse (overload and short circuit protection)



Push-in CAGE CLAMP® connection technology



Various marking options for clear identification

Illustration	Primary Rated Current	Secondary Rated Current	Rated Power	Accuracy Class	Fuse (Voltage Path)	Item No.
<b>Current and Voltage Tap</b>						
	150 A	1 A	0.2 VA	0.5	2 A; 450 V; F, 70 kA; 5 x 25 mm	855-501/150-000
	250 A	1 A	0.2 VA	0.5	2 A; 450 V; F, 70 kA; 5 x 25 mm	855-951/250-000
	350 A	1 A	0.2 VA	0.5	2 A; 450 V; F, 70 kA; 5 x 25 mm	855-1851/350-00



Feedthrough for primary conductors



Integrated fuse



Installation via jumper slot



Marking with marking strips

# WAGO System Wiring – 706 Series

## Compatible with: Siemens; GE

Siemens S7-1500 PLC							
PLC		WAGO Interface Cable		WAGO Interface Modules			
PLC I/O Assembly		Item No.	Qty.	Type	Qty.		
CPU	16 DI	706-2500/305-XXXX	1	T16ES	1		
	16 DO			T16S	1		
	5 AI/2 AO			A8TSX	1		
	32 DI			T16ES	2		
	32 DO			T16S	2		
6ES7 512-1CK00-0AB0	5 AI/2 AO	706-2500/600-XXXX	1	A8TSX	1		
DI	16 DI	706-2500/300-XXXX	1	T16ES	1		
	16 DI	706-2500/304-XXXX	1	T16ES	1		
	16 DI	706-2500/300-XXXX	1	704-2224	1		
	32 DI	706-2500/301-XXXX	1	T16ES	2		
	32 DI	706-2500/303-XXXX	1	T16ES	2		
	16 DI	706-2500/102-XXXX	1	T16ESHT	1		
	16 DI	706-2500/302-XXXX	1	T16ESHT	1		
	DO	8 DO	706-2500/201-XXXX	1	T8(E)S	1	
		16 DO	706-2500/300-XXXX	1	T16(E)S	1	
		16 DO	706-2500/300-XXXX	1	T16(E)S	1	
16 DO		706-2500/304-XXXX	1	T16(E)S	1		
32 DO		706-2500/301-XXXX	1	T16(E)S	2		
32 DO		706-2500/303-XXXX	1	T16(E)S	2		
16 DO		706-2500/302-XXXX	1	T16ESHT	1		
8 DO		706-2500/204-XXXX	1	T16ESHT	1		
16 DO		706-2500/202-XXXX	1	T16ESHT	1		
8 DO		706-2500/204-XXXX	1	T16ESHT	1		
16 DO		706-2500/202-XXXX	1	T16ESHT	1		
DI/DO		16 DI	706-2500/303-XXXX	1	T16ES	1	
		16 DO			T16S	1	
AI		8 AI	706-2500/400-XXXX	1	A8ES	1	
		8 AI	706-2500/401-XXXX	1	A8ES	1	
	8 AI	706-2500/400-XXXX	1	A8ES	1		
	8 AI	706-2500/401-XXXX	1	A8ES	1		
	8 AI	706-2500/400-XXXX	1	A8ES	1		
	8 AI	706-2500/401-XXXX	1	A8ES	1		
	8 AI	706-2500/405-XXXX	1	A8ES	1		
	4 AI	706-2500/402-XXXX	1	A4ES	1		
	4 AI	706-2500/403-XXXX	1	A4ES	1		
	AO	4 AO	706-2500/500-XXXX	1	A4ES	1	
4 AO		706-2500/501-XXXX	1	A4ES	1		
8 AO		706-2500/502-XXXX	1	A8ES	1		
8 AO		706-2500/503-XXXX	1	A8ES	1		
4 AO		706-2500/500-XXXX	1	A4ES	1		
4 AO		706-2500/501-XXXX	1	A4ES	1		
AI/AO	4 AI + 2 AO	706-2500/601-XXXX	1	A8ES	1		
	4 AI + 2 AO	706-2500/602-XXXX	1	A8ES	1		
	4 AI + 2 AO	706-2500/603-XXXX	1	A8ES	1		
SAFETY	16 DI	706-2500/103-XXXX	1	T16ES	1		
	8 DO	706-2500/205-XXXX	1	T16ES	1		

Siemens S7-400 PLC						
PLC		WAGO Interface Cable		WAGO Interface Modules		
PLC I/O Assembly		Item No.	Qty.	Type	Qty.	
DI	32 DI	706-2400/300-XXXX	1	T16ES	2	
	16 DI	706-2400/100-XXXX	1	T16ES	2	
DO	32 DO	706-2400/300-XXXX	1	T16(E)S	2	
	8 DO	706-2400/201-XXXX	1	T8ESHT	1	
	16 DO	706-2400/202-XXXX	1	T16ESHT	2	
	32 DO	706-2400/300-XXXX	1	T16ES	2	
	AI	8 AI	706-2400/404-XXXX	1	A8ES	1
8 AI		706-2400/405-XXXX	1	A8ES	1	
8 AI		706-2400/401-XXXX	1	A8ES	1	
8 AI		706-2400/401-XXXX	1	A8ES	1	
8 AI		706-2400/402-XXXX	1	A8ES	1	
8 AI		706-2400/403-XXXX	1	A8ES	1	
8 AI		706-2400/500-XXXX	1	A8ES	1	
AO	8 AO	706-2400/501-XXXX	1	A8ES	1	
	8 AO	706-2400/501-XXXX	1	A8ES	1	

GE Fanuc 90-30/ALSPA 80-35 PLC						
PLC		WAGO Interface Cable		WAGO Interface Modules		
PLC I/O Assembly		Item No.	Qty.	Type	Qty.	
DI	8 DI	706-5030/301-XXXX	1	T8ESHT	2	
	8 DI	706-5030/301-XXXX	1	T8ESHT	2	
	16 DI	706-5030/100-XXXX	1	T16ESHT	1	
	16 DI	706-5030/101-XXXX	1	T16ES	1	
	8 DI	706-5030/302-XXXX	1	T8ESHT	1	
	8 DI	706-5030/303-XXXX	1	T8ES	1	
	16 DI	706-5030/101-XXXX	1	T16ES	1	
	16 DI	706-5030/101-XXXX	1	T16ES	1	
	16 DI	706-5030/101-XXXX	1	T16ES	1	
	32 DI	706-5030/300-XXXX	2	T16ES	2	
DO	12 DO	706-5030/200-XXXX	1	T16ESHT	1	
	8 DO	706-5030/302-XXXX	1	T8ESHT	1	
	16 DO	706-5030/200-XXXX	1	T16ESHT	1	
	5 DO	706-5030/203-XXXX	1	T16ESHT	1	
	8 DO	706-5030/201-XXXX	1	T8(E)S	1	
	8 DO	706-5030/303-XXXX	1	T8(E)S	1	
	6 DO	706-5030/204-XXXX	1	T16ESHT	1	
	16 DO	706-5030/202-XXXX	1	T16(E)S	1	
	16 DO	706-5030/202-XXXX	1	T16(E)S	1	
	32 DO	706-5030/300-XXXX	2	T16(E)S	2	
DI/DO	8 DI	706-5030/301-XXXX	1	T8ESHT	1	
	8 DO			T8ESHT	1	
	8 DO			T8ESHT	1	
AI	4 AI	706-5030/400-XXXX	1	A4ES	1	
	4 AI	706-5030/400-XXXX	1	A4ES	1	
	16 AI	706-5030/402-XXXX	1	A8ES	2	
	16 AI	706-5030/402-XXXX	1	A8ES	2	
	8 AO	706-5030/500-XXXX	1	A8ES	1	
	8 AO	706-5030/501-XXXX	1	A8ES	1	

GE Fanuc RX3i PLC						
PLC		WAGO Interface Cable		WAGO Interface Modules		
PLC I/O Assembly		Item No.	Qty.	Type	Qty.	
DI	32 DI	706-5030/300-XXXX	2	T16ES	2	
	32 DO	706-5030/300-XXXX	2	T16(E)S	2	
AI	8 AI	706-5030/402-XXXX	1	A8ES	2	
	8 AO	706-5030/500-XXXX	1	A8ES	1	
AO	8 AO	706-5030/501-XXXX	1	A8ES	1	
	8 AO	706-5030/501-XXXX	1	A8ES	1	

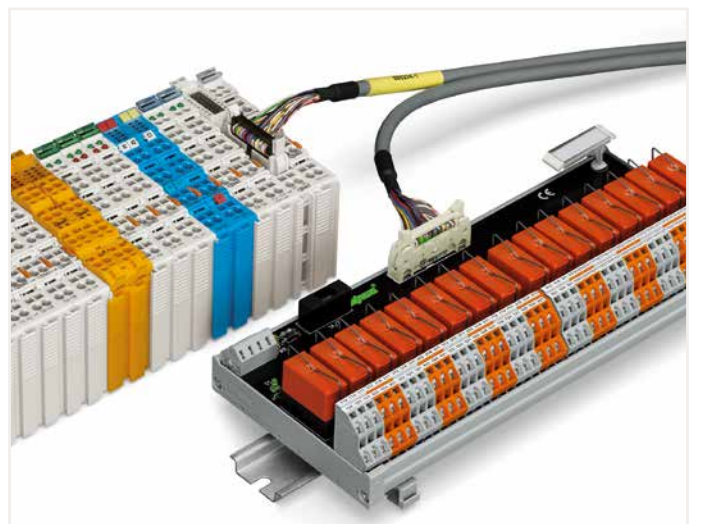

System cables for Siemens S7-300, Schneider Twido and Schneider TSX 37 upon request

10



## WAGO System Wiring – 706 Series

### Compatible with: Schneider

Schneider Modicon M221/M241/M251 (TM3) PLC						
PLC			WAGO Interface Cable		WAGO Interface Modules	
PLC I/O Assembly			Item No.	Qty.	Type	Qty.
DI	TM3 DI8A	8 DI	706-3033/102-XXXX	1	T8ESHT	1
	TM3 DI8(G)	8 DI	706-3033/103-XXXX	1	T8ES	1
	TM3 DI16(G)	16 DI	706-3033/104-XXXX	1	T16ES	1
	TM3 DI16K	16 DI	706-3033/100-XXXX	1	T16ES	1
	TM3 DI32K	32 DI	706-3033/100-XXXX	2	T16ES	2
DO	TM3 DQ8T(G)	8 DO	706-3033/202-XXXX	1	T8(E)S	1
	TM3 DQ16T(G)	16 DO	706-3033/203-XXXX	1	T16(E)S	1
	TM3 DQ16TK	16 DO	706-3033/200-XXXX	1	T16(E)S	1
AI	TM3 DQ32TK	32 DO	706-3033/200-XXXX	2	T16(E)S	2
	TM3 AI2H(G)	2 AI	706-3033/400-XXXX	1	A4ES	1
	TM3 AI4(G)	4 AI	706-3033/401-XXXX	1	A4ES	1
	TM3 AI4(G)	4 AI	706-3033/401-XXXX	1	A4ES	1
AO	TM3 AI8(G)	8 AI	706-3033/402-XXXX	1	A8ES	1
	TM3 AI8T(G)	8 AI	706-3033/402-XXXX	1	A8ES	1
	TM3 AO2(G)	2 AO	706-3033/500-XXXX	1	A4ES	1
AI/AO	TM3 AQ4(G)	4 AO	706-3033/501-XXXX	1	A4ES	1
	TM3 AM6(G)	4 AI / 2 AO	706-3033/600-XXXX	1	A8ES	1
	TM3 TM3(G)	2 AI / 1 AO	706-3033/601-XXXX	1	A4ES	1

Schneider TSX 57 (Premium) PLC						
PLC			WAGO Interface Cable		WAGO Interface Modules	
PLC I/O Assembly			Item No.	Qty.	Type	Qty.
DI	TSX DEY 08D2	8 DI	706-3057/301-XXXX	1	T8ES	1
	TSX DEY 16A2	16 DI	706-3057/100-XXXX	1	T16ESHT	1
	TSX DEY 16A3	16 DI	706-3057/100-XXXX	1	T16ESHT	1
	TSX DEY 16A4	16 DI	706-3057/100-XXXX	1	T16ESHT	1
	TSX DEY 16A5	16 DI	706-3057/100-XXXX	1	T16ESHT	1
	TSX DEY 16D2	16 DI	706-3057/302-XXXX	1	T16ES	1
	TSX DEY 16D3	16 DI	706-3057/100-XXXX	1	T16ESHT	1
	TSX DEY 16FK	16 DI	706-3057/300-XXXX	1	T16ES	1
	TSX DEY 32D2K	32 DI	706-3057/300-XXXX	2	T16ES	2
	TSX DEY 64D2K	64 DI	706-3057/300-XXXX	4	T16ES	4
DO	TSX DSY 08R4	8 DO	706-3057/204-XXXX	1	T16ESHT	1
	TSX DSY 08R5	8 DO	706-3057/201-XXXX	1	T16ESHT	1
	TSX DSY 08R5A	8 DO	706-3057/204-XXXX	1	T16ESHT	1
	TSX DSY 08S5	8 DO	706-3057/202-XXXX	1	T8ESHT	1
	TSX DSY 08T2	8 DO	706-3057/301-XXXX	1	T8(E)S	1
	TSX DSY 08T22	8 DO	706-3057/203-XXXX	1	T8ESHT	1
	TSX DSY 08T31	8 DO	706-3057/203-XXXX	1	T8ESHT	1
	TSX DSY 16R5	16 DO	706-3057/201-XXXX	1	T16ESHT	1
	TSX DSY 16S4	16 DO	706-3057/201-XXXX	1	T16ESHT	1
	TSX DSY 16S5	16 DO	706-3057/201-XXXX	1	T16ESHT	1
	TSX DSY 16T2	16 DO	706-3057/302-XXXX	1	T16(E)S	1
	TSX DSY 32T2K	32 DO	706-3057/300-XXXX	2	T16(E)S	2
	TSX DSY 64T2K	64 DO	706-3057/300-XXXX	4	T16(E)S	4
DI/DO	TSX DMY 28FK	16 DI	706-3057/300-XXXX	1	T16ES	1
	TSX DMY 28RFK	12 DO	706-3057/200-XXXX	1	T16(E)S	1
AI	TSX AEY 414	16 DI	706-3057/300-XXXX	1	T16ES	1
	TSX AEY 414	12 DO	706-3057/200-XXXX	1	T16(E)S	1
	TSX AEY 420	4 AI	706-3057/601-XXXX	1	A4ES	1
	TSX AEY 800	4 AI	706-3057/400-XXXX	1	A8ES	1
	TSX AEY 810	4 AI	706-3057/600-XXXX	1	A8TSX	1
	TSX AEY 1600	8 AI	706-3057/600-XXXX	2	A8TSX	2
AO	TSX ASY 410	16 AI	706-3057/600-XXXX	2	A8TSX	2
	TSX ASY 410	4 AO	706-3057/601-XXXX	1	A4ES	1
	TSX ASY 800	4 AO	706-3057/500-XXXX	1	A4ES	1

Schneider Quantum PLC							
PLC			WAGO Interface Cable		WAGO Interface Modules		
PLC I/O Assembly			Item No.	Qty.	Type	Qty.	
DI	140 DAI 340 00	16 DI	706-3140/300-XXXX	1	T16ESHT	2	
	140 DAI 353 00	32 DI	706-3140/300-XXXX	1	T16ESHT	2	
	140 DAI 440 00	16 DI	706-3140/300-XXXX	1	T16ESHT	2	
	140 DAI 453 00	32 DI	706-3140/300-XXXX	1	T16ESHT	2	
	140 DAI 540 00	16 DI	706-3140/300-XXXX	1	T16ESHT	2	
	140 DAI 543 00	16 DI	706-3140/300-XXXX	1	T16ESHT	2	
	140 DAI 553 00	32 DI	706-3140/300-XXXX	1	T16ESHT	2	
	140 DAI 740 00	16 DI	706-3140/300-XXXX	1	T16ESHT	2	
	140 DAI 753 00	32 DI	706-3140/300-XXXX	1	T16ESHT	2	
	140 DDI 353 00	32 DI	706-3140/301-XXXX	1	T16ES	2	
	140 DDI 364 00	96 DI	706-3057/300-XXXX	6	T16ES	6	
	140 DSI 353 00	32 DI	706-3140/301-XXXX	1	T16ES	2	
	140 DAO 840 00	16 DO	706-3140/300-XXXX	1	T16ESHT	2	
	140 DAO 840 10	16 DO	706-3140/300-XXXX	1	T16ESHT	2	
DO	140 DDO 353 00	32 DO	706-3140/301-XXXX	1	T16(E)S	2	
	140 DDO 353 01	32 DO	706-3140/301-XXXX	1	T16(E)S	2	
	140 DDO 364 00	96 DO	706-3057/300-XXXX	6	T16(E)S	6	
	140 DRA 840 00	16 DO	706-3140/300-XXXX	1	T16ESHT	2	
	140 DVO 853 00	32 DO	706-3140/301-XXXX	1	T16(E)S	2	
	DI/DO	140 DDM 390 00	16 DI	706-3140/302-XXXX	1	T16ES	1
			8 DO			T8(E)S	1
	AI	140 ACI 030 00	8 AI	706-3140/400-XXXX	1	A8ES	1
		140 ACI 030 00	8 AI	706-3140/401-XXXX	1	A8ES	1
		140 ACI 040 00	16 AI	706-3140/402-XXXX	1	A8ES	2
140 ARI 030 10		8 AI	706-3140/402-XXXX	1	A8ES	2	
140 AVI 030 00		8 AI	706-3140/400-XXXX	1	A8ES	1	
140 AVI 030 00		8 AI	706-3140/401-XXXX	1	A8ES	1	
AO	140 ACO 020 00	4 AO	706-3140/500-XXXX	1	A4ES	1	
	140 ACO 130 00	8 AO	706-3140/501-XXXX	1	A8ES	1	

Schneider M340/M580 PLC							
PLC			WAGO Interface Cable		WAGO Interface Modules		
PLC I/O Assembly			Item No.	Qty.	Type	Qty.	
DI	BMX DAI 1602	16 DI	706-3340/300-XXXX	1	T16ESHT	1	
	BMX DAI 1603	16 DI	706-3340/300-XXXX	1	T16ESHT	1	
	BMX DAI 1604	16 DI	706-3340/300-XXXX	1	T16ESHT	1	
	BMX DDI 1602	16 DI	706-3340/301-XXXX	1	T16ES	1	
	BMX DDI 1603	16 DI	706-3340/300-XXXX	1	T16ESHT	1	
	BMX DDI 3202K	32 DI	706-3340/302-XXXX	1	T16ES	2	
	BMX DDI 6402K	64 DI	706-3340/302-XXXX	2	T16ES	4	
	BMX DAO 1605	16 DO	706-3340/200-XXXX	1	T16ESHT	1	
	BMX DDO 1602	16 DO	706-3340/301-XXXX	1	T16(E)S	1	
	BMX DDO 3202K	32 DO	706-3340/302-XXXX	1	T16(E)S	2	
DO	BMX DDO 6402K	64 DO	706-3340/302-XXXX	2	T16(E)S	4	
	BMX DRA 0805	8 DO	706-3340/300-XXXX	1	T16ESHT	1	
	BMX DRA 1605	16 DO	706-3340/201-XXXX	1	T16ESHT	1	
	DI/DO	BMX DDM 16022	8 DI	706-3340/303-XXXX	1	T8ES	1
			8 DO			T8S	1
	AI	BMX DDM 16025	8 DI	706-3340/304-XXXX	1	T8ES	1
			8 DO			T8ESHT	1
	AO	BMX DDM 3202K	16 DI	706-3340/302-XXXX	1	T16ES	1
			16 DO			T16S	1
		BMX AMI 0410	4 AI	706-3340/400-XXXX	1	A4ES	1
BMX AMI 0410		4 AI	706-3340/401-XXXX	1	A4ES	1	
BMX ART 0414		4 AI	706-3340/402-XXXX	1	A8ES	1	
BMX ART 0814		8 AI	706-3340/402-XXXX	2	A8ES	2	
BMX AMI 0800		8 AI	706-3340/403-XXXX	1	A8ES	1	
BMX AMI 0800		8 AI	706-3340/404-XXXX	1	A8ES	1	
BMX AMI 0810		8 AI	706-3340/403-XXXX	1	A8ES	1	
BMX AMI 0810		8 AI	706-3340/404-XXXX	1	A8ES	1	
AO	BMX AMM 0600	4 AI+2 AO	706-3340/500-XXXX	1	A8ES	1	
	BMX AMM 0600	4 AI+2 AO	706-3340/501-XXXX	1	A8ES	1	
	BMX AMO 0210	2 AO	706-3340/502-XXXX	1	A4ES	1	
	BMX AMO 0410	4 AO	706-3340/401-XXXX	1	A4ES	1	
	BMX AMO 0802	8 AO	706-3340/504-XXXX	1	A8ES	1	

# WAGO System Wiring – 706 Series

## Compatible with: WAGO; Omron; Rockwell

WAGO I/O System 753 PLC						
PLC			WAGO Interface Cable		WAGO Interface Modules	
PLC I/O Assembly			Item No.	Qty.	Type	Qty.
DI	753-430 (x1)	8 DI	706-7753/300-XXXX	1	T8ES	1
	753-430 (x2)	16 DI	706-7753/301-XXXX	1	T16ES	1
	753-431 (x1)	8 DI	706-7753/300-XXXX	1	T8ES	1
	753-431 (x2)	16 DI	706-7753/301-XXXX	1	T16ES	1
DO	753-530 (x1)	8 DO	706-7753/300-XXXX	1	T8(E)S	1
	753-530 (x2)	16 DO	706-7753/301-XXXX	1	T16(E)S	1
AI	753-453 (x1)	4 AI	706-7753/602-XXXX	1	A4ES	1
	753-453 (x2)	8 AI	706-7753/601-XXXX	1	A8ES	1
	753-455 (x1)	4 AI	706-7753/602-XXXX	1	A4ES	1
	753-455 (x2)	8 AI	706-7753/601-XXXX	1	A8ES	1
	753-457 (x1)	4 AI	706-7753/602-XXXX	1	A4ES	1
	753-457 (x2)	8 AI	706-7753/601-XXXX	1	A8ES	1
	753-459 (x1)	4 AI	706-7753/602-XXXX	1	A4ES	1
	753-459 (x2)	8 AI	706-7753/601-XXXX	1	A8ES	1
AO	753-553 (x1)	4 AO	706-7753/602-XXXX	1	A4ES	1
	753-553 (x2)	8 AO	706-7753/601-XXXX	1	A8ES	1
	753-555 (x1)	4 AO	706-7753/602-XXXX	1	A4ES	1
	753-555 (x2)	8 AO	706-7753/601-XXXX	1	A8ES	1
	753-557 (x1)	4 AO	706-7753/602-XXXX	1	A4ES	1
	753-557 (x2)	8 AO	706-7753/601-XXXX	1	A8ES	1
	753-559 (x1)	4 AO	706-7753/602-XXXX	1	A4ES	1
	753-559 (x2)	8 AO	706-7753/601-XXXX	1	A8ES	1

WAGO I/O System 750 PLC						
PLC			WAGO Interface Cable		WAGO Interface Modules	
PLC I/O Assembly			Item No.	Qty.	Type	Qty.
DI	750-1400	16 DI	706-3057/300-XXXX	1	T16ES	1
	750-1500	16 DO	706-3057/300-XXXX	1	T16(E)S	1
DO	750-1502	8 DI	706-7753/302-XXXX	1	T8ES	1
	750-1502	8 DO	706-7753/302-XXXX	1	T8(E)S	1
DI/DO	750-1502	8 DI	706-3057/300-XXXX	1	T16ES	1
	750-1502	8 DO	706-3057/300-XXXX	1	T16ES	1

Omron C.J1 PLC							
PLC			WAGO Interface Cable		WAGO Interface Modules		
PLC I/O Assembly			Item No.	Qty.	Type	Qty.	
DI	CJ1W-ID201	8 DI	706-100/310-XXXX	1	T8ES	1	
	CJ1W-ID211	16 DI	706-100/320-XXXX	1	T16ES	1	
	CJ1W-ID231	32 DI	706-6001/100-XXXX	1	T16ES	2	
	CJ1W-ID232	32 DI	706-6001/300-XXXX	1	T16ES	2	
	CJ1W-ID261	64 DI	706-6001/100-XXXX	2	T16ES	4	
	CJ1W-ID262	64 DI	706-6001/300-XXXX	2	T16ES	4	
	CJ1W-IDP01	16 DI	706-100/320-XXXX	1	T16ES	1	
	CJ1W-INT01	16 DI	706-100/320-XXXX	1	T16ES	1	
	DO	CJ1W-OD204	8 DO	706-100/310-XXXX	1	T8(E)S	1
		CJ1W-OD212	16 DO	706-100/320-XXXX	1	T16(E)S	1
CJ1W-OD232		32 DO	706-6001/300-XXXX	1	T16(E)S	2	
CJ1W-OD262		64 DO	706-6001/300-XXXX	2	T16(E)S	4	
DI/DO	CJ1W-MD232	16 DI	706-6001/301-XXXX	1	T16ES	1	
	CJ1W-MD232	16 DO	706-6001/301-XXXX	1	T16ES	1	

Rockwell Compact Logix (1769) PLC						
PLC			WAGO Interface Cable		WAGO Interface Modules	
PLC I/O Assembly			Item No.	Qty.	Type	Qty.
DI	1769-IA16	16 DI	706-4769/300-XXXX	1	T16ESHT	1
	1769-IM12	12 DI	706-4769/300-XXXX	1	T16ESHT	1
	1769-IQ16	16 DI	706-4769/100-XXXX	1	T16ES	1
	1769-IQ16F	16 DI	706-4769/100-XXXX	1	T16ES	1
	1769-IQ32	32 DI	706-4769/102-XXXX	1	T16ES	2
	1769-IQ32T	32 DI	706-4769/101-XXXX	1	T16ES	2
DO	1769-OA8	8 DO	706-4769/201-XXXX	1	T8ESHT	1
	1769-OA16	16 DO	706-4769/200-XXXX	1	T16ESHT	1
	1769-OB8	8 DO	706-4769/202-XXXX	1	T8(E)S	1
	1769-OB16	16 DO	706-4769/203-XXXX	1	T16(E)S	1
	1769-OB16P	16 DO	706-4769/203-XXXX	1	T16(E)S	1
	1769-OB32	32 DO	706-4769/204-XXXX	1	T16(E)S	2
	1769-OB32T	32 DO	706-4769/301-XXXX	1	T16(E)S	2
	1769-OW8	8 DO	706-4769/201-XXXX	1	T8ESHT	1
	1769-OW8I	8 DO	706-4769/300-XXXX	1	T16ESHT	1
	1769-OW16	16 DO	706-4769/200-XXXX	1	T16ESHT	1
DI/DO	1769-IQ6XOW4	6 DI	706-4769/0302-XXXX	1	T16ESHT	1
	1769-IQ6XOW4	4 DO	706-4769/0302-XXXX	1	T16ESHT	1
AI	1769-IF4	4 AI	706-4769/400-XXXX	1	A4ES	1
	1769-IF4	4 AI	706-4769/401-XXXX	1	A4ES	1
	1769-IF4I	4 AI	706-4769/402-XXXX	1	A4ES	1
	1769-IF4I	4 AI	706-4769/403-XXXX	1	A4ES	1
	1769-IF8	8 AI	706-4769/405-XXXX	1	A4ES	2
	1769-IF8	8 AI	706-4769/406-XXXX	1	A4ES	2
	1769-IR6	6 AI	706-4769/404-XXXX	1	A8ES	2
	1769-IF4XOF2 (F)	4 AI+ 2 AO	706-4769/600-XXXX	1	A8ES	1
	1769-IF4XOF2 (F)	4 AI+ 2 AO	706-4769/601-XXXX	1	A8ES	1
	1769-IF16C	16 AI	706-4769/408-XXXX	1	A8ES	2
	1769-OF2	2 AO	706-4769/500-XXXX	1	A4ES	1
	1769-OF4	4 AO	706-4769/503-XXXX	1	A4ES	1
	1769-OF4	4 AO	706-4769/504-XXXX	1	A4ES	1
	1769-OF4CI	4 AO	706-4769/501-XXXX	1	A4ES	1
	1769-OF4VI	4 AO	706-4769/501-XXXX	1	A4ES	1
	1769-OF8V	8 AO	706-4769/502-XXXX	1	A8ES	1
1769-OF8C	8 AO	706-4769/502-XXXX	1	A8ES	1	

Rockwell Control Logix (1756) PLC						
PLC			WAGO Interface Cable		WAGO Interface Modules	
PLC I/O Assembly			Item No.	Qty.	Type	Qty.
DI	1756-IA16I	16 DI	706-4756/302-XXXX	1	T16ESHT	2
	1756-IB16I	16 DI	706-4756/301-XXXX	1	T16ES	2
	1756-IB16ISOE	16 DI	706-4756/301-XXXX	1	T16ES	2
	1756-IB32	32 DI	706-4756/102-XXXX	1	T16ES	2
	1756-IH16I	16 DI	706-4756/302-XXXX	1	T16ESHT	2
	1756-IH16ISOE	16 DI	706-4756/302-XXXX	1	T16ESHT	2
	1756-IM16I	16 DI	706-4756/302-XXXX	1	T16ESHT	2
	1756-OA16I	16 DO	706-4756/302-XXXX	1	T16ESHT	2
	1756-OB16E	16 DO	706-4756/203-XXXX	1	T16(E)S	1
	1756-OB16I	16 DO	706-4756/301-XXXX	1	T16ES	2
DO	1756-OB16IS	16 DO	706-4756/301-XXXX	1	T16ES	2
	1756-OB32	32 DO	706-4756/207-XXXX	1	T16(E)S	2
	1756-OC8	8 DO	706-4756/202-XXXX	1	T8ESHT	1
	1756-OH8I	8 DO	706-4756/302-XXXX	1	T16ESHT	2
	1756-OW16I	16 DO	706-4756/302-XXXX	1	T16ESHT	2
	1756-OX8I	8 DO	706-4756/302-XXXX	1	T16ESHT	2
	1756-IF6CIS	6 AI	706-4756/411-XXXX	1	A8ES	1
	1756-IF6CIS	6 AI	706-4756/412-XXXX	1	A8ES	1
	1756-IF6I	6 AI	706-4756/408-XXXX	1	A8ES	1
	1756-IF6I	6 AI	706-4756/409-XXXX	1	A8ES	1
AI	1756-IF8	8 AI	706-4756/402-XXXX	1	A8ES	1
	1756-IF8	8 AI	706-4756/403-XXXX	1	A8ES	1
	1756-IF8H	8 AI	706-4756/404-XXXX	1	A8ES	1
	1756-IF8H	8 AI	706-4756/405-XXXX	1	A8ES	1
	1756-IF16	16 AI	706-4756/406-XXXX	1	A8ES	2
	1756-IF16	16 AI	706-4756/407-XXXX	1	A8ES	2
	1756-IR6I	16 AI	706-4756/410-XXXX	1	A8ES	2
	1756-OF4	4 AO	706-4756/500-XXXX	1	A4ES	1
AO	1756-OF4	4 AO	706-4756/501-XXXX	1	A4ES	1
	1756-OF6CI	6 AO	706-4756/502-XXXX	1	A8ES	1
	1756-OF6VI	6 AO	706-4756/502-XXXX	1	A8ES	1
	1756-OF8	8 AO	706-4756/503-XXXX	1	A8ES	1
	1756-OF8	8 AO	706-4756/504-XXXX	1	A8ES	1
	1756-OF8H	8 AO	706-4756/503-XXXX	1	A8ES	1
	1756-OF8H	8 AO	706-4756/504-XXXX	1	A8ES	1
	1756-OF8H	8 AO	706-4756/504-XXXX	1	A8ES	1

# WAGO System Wiring – 289 / 704 / 706 Series Interface Modules

WAGO Interface Modules			
Type	Description	Dimensions in mm (W x H x D)	Item No.
D/DO	T8ES	10-pole; without supply	35 x 48 x 85
		10-pole; with LED; 3-wire	56 x 63 x 85
	T8ESHT	12-pole (MCS); without LED; 2 conductors; up to 250 V	
	T8S	10-pole; with LED; electrical isolation: 5 A relay	70 x 65 x 105
		10-pole; with LED; electrical isolation: 5 A relay; manual operation	75 x 65 x 105
	T16ES	20-pole; without supply	47 x 62 x 85
		20-pole; with LED; 1-wire	55 x 50 x 85
		20-pole; with LED; 1-wire; channel isolation	
		20-pole; with LED; 2-wire	85 x 50 x 85
		20-pole; with LED; 2-wire; channel fuse	
		20-pole; with LED; 2-wire; channel isolation	99 x 50 x 85
		20-pole; with LED; 3-wire	85 x 63 x 85
		20-pole; with LED; 3-wire; channel isolation	
		20-pole; with LED; 2-wire; 0 V/channel isolation	
		20-pole; without LED; 2-wire	
	T16ESHT	2 x 10-pole (MCS); without LED; 2-wire; up to 250 V	
20-pole; with LED; electrical isolation: 5 A relay		180 x 50 x 105	
T16S	20-pole; with LED; electrical isolation: 5 A relay	111 x 65 x 105	
	20-pole; with LED; electrical isolation: 5 A relay; channel fuse	247 x 55 x 105	
	20-pole; with LED; electrical isolation: 5 A relay; manual operation	121 x 65 x 105	
	20-pole; with LED; electrical isolation: 5 A relay; 0 V isolation; channel fuse	240 x 55 x 105	
	20-pole; with LED; electrical isolation: 5 A relay (2 u)	247 x 50 x 105	
	20-pole; with LED; electrical isolation: 5 A relay (1 a); 0 V/channel isolation; channel fuse	240 x 55 x 105	
A/AO	A4ES	15-pole sub-D; 2- and 4-wire	
		15-pole sub-D; 2- and 4-wire; isolation	66 x 50 x 105
	A8ES	25-pole sub-D; 2- and 4-wire	
		25-pole sub-D; 2- and 4-wire; isolation	92 x 50 x 105
A8TSX	25-pole sub-D; current and voltage signal		

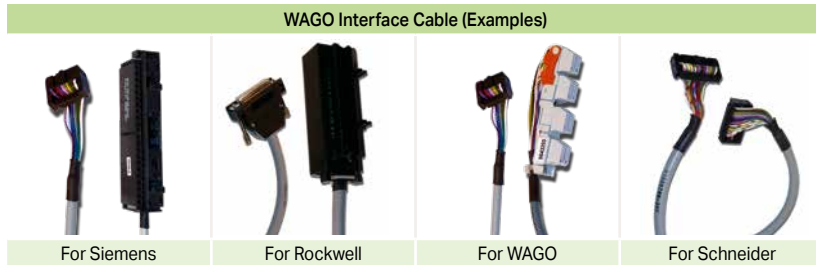

Cable Length Overview			
Item No.	-XXXX	Length	Example
706-2300/201-XXXX	-100	1 m	706-2300/201-100
	-200	2 m	706-2300/201-200
	-300	3 m	706-2300/201-300
Additional cable lengths upon request			

Accessories		
Illustration	Description	Item No.
	Simulation set; for 8 / 16 digital PLC inputs/outputs; channel indicator with LED (green); 20-pole; 24 VDC (includes cable for simulation of digital outputs)	704-9027

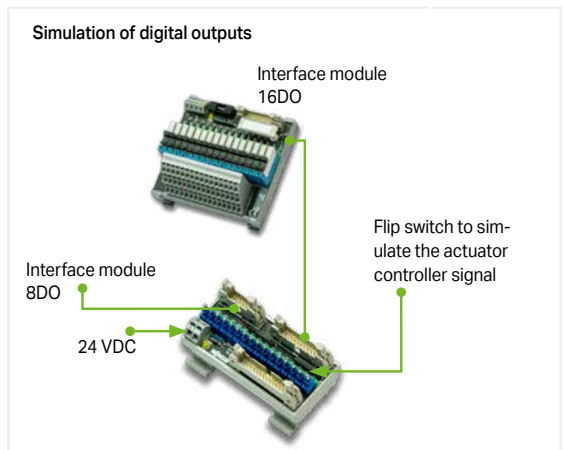
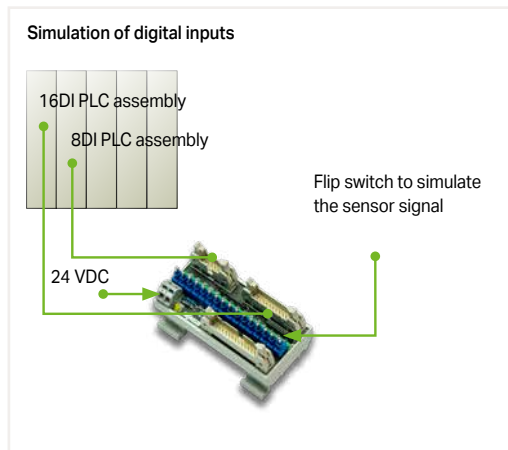









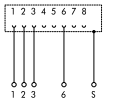

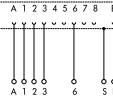

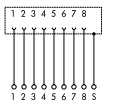

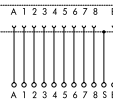

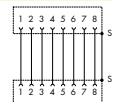

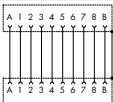

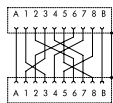
# WAGO Interface Modules, Sub-Min-D/HD-Sub-D/Connectors per DIN 41651 – 289 Series

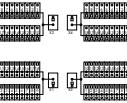
Illustration	Circuit Diagram	Pole Number	Operating Voltage	Nominal Current	Dimensions in mm (W x H x D)	Item No.
<b>Interface Module; sub-min-D; male header; mating connector with solder contact</b>						
		9	125 VAC/DC	2 A	38 x 34 x 85	289-545
		15			53.5 x 34 x 85	289-546
		25			79 x 34 x 85	289-547
		37			120 x 34 x 85	289-548
		50			157 x 34 x 85	289-549
<b>Interface Module; sub-min-D; male header; mating connector with Insulation Displacement Connection (IDC)</b>						
		9	125 VAC/DC	2 A	38 x 34 x 85	289-540
		15			46 x 34 x 85	289-541
		25			72 x 34 x 85	289-542
		37			102 x 34 x 85	289-543
		50			94 x 34 x 85	289-544
<b>Interface Module; sub-min-D; socket; mating connector with solder contact</b>						
		9	125 VAC/DC	2 A	38 x 34 x 85	289-555
		15			46 x 34 x 85	289-556
		25			72 x 34 x 85	289-557
		37			102 x 34 x 85	289-558
		50			94 x 34 x 85	289-559
<b>Interface Module; sub-min-D; male header; mating connector with Insulation Displacement Connection (IDC)</b>						
		9	125 VAC/DC	2 A	38 x 34 x 85	289-550
		15			46 x 34 x 85	289-551
		25			72 x 34 x 85	289-552
		37			102 x 34 x 85	289-553
		50			94 x 34 x 85	289-554
<b>Interface Module; sub-min-D; male header; mating connector with solder contact; with solder terminal</b>						
		9	≤ 30 VAC; ≤ 50 VDC	2 A	33.5 x 48 x 85	289-720
		15			43.5 x 48 x 85	289-721
<b>Interface Module; sub-min-D; socket; mating connector with solder contact; with solder terminal</b>						
		9	≤ 30 VAC; ≤ 50 VDC	2 A	33.5 x 48 x 85	289-725
		15			43.5 x 48 x 85	289-726
<b>Interface Module; HD-sub-D; male header</b>						
		15	125 VAC/DC	1 A	35 x 62 x 85	289-714
		62			108 x 62 x 85	289-710
<b>Interface Module; HD-sub-D; socket</b>						
		15	125 VAC/DC	1 A	35 x 62 x 85	289-713
		44			79 x 62 x 85	289-707
		62			108 x 62 x 85	289-708
<b>Interface Module; DIN 41651 connector; male header; 2-row PCB terminal blocks</b>						
		10	125 VAC/DC	1 A	38 x 36 x 85	289-501
		14			43 x 36 x 85	289-502
		16			46 x 36 x 85	289-503
		20			53.5 x 36 x 85	289-504
		26			71 x 36 x 85	289-505
		34			94 x 36 x 85	289-506
		40			114 x 36 x 85	289-507
		50			132 x 36 x 85	289-508
64	170 x 36 x 85	289-509				
<b>Interface Module; DIN 41651 connector; male header; multi-level PCB terminal blocks</b>						
		10	125 VAC/DC	1 A	35 x 45 x 85	289-611
		14			40 x 45 x 85	289-612
		16			45 x 45 x 85	289-613
		20	125 VAC/DC	1 A	47 x 62 x 85	289-614
		26			55 x 62 x 85	289-615
		34			65 x 62 x 85	289-616
		40			74 x 62 x 85	289-617
		50			88 x 62 x 85	289-618
		64			114 x 62 x 85	289-619

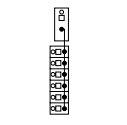
10

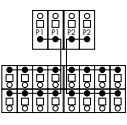
## WAGO RJ-45 Interface Modules; Potential Distribution Modules – 289 Series

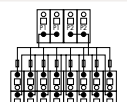
Illustration	Circuit Diagram	Pole Number	Nominal Current	Connection Cable	Specialty Function	Dimensions in mm (W x H x D)	Item No.	
<b>Interface Module; RJ-45; PCB terminal blocks; with shield connection</b>								
		4	1.5 A	Min. cat. 5	With shield clamping saddle	24 x 40 x 85	289-174 289-174/790-108	
		6	2.1 A	Min. cat. 5	With shield clamping saddle; with power jumper contacts	30 x 67 x 85	289-178	
<b>Interface Module; RJ-45; 2-row PCB terminal blocks; with shield connection</b>								
		8	1.5 A	Min. cat. 5	With shield clamping saddle	24 x 40 x 85	289-175 289-175/790-108	
		10	2.1 A	Min. cat. 5	With shield clamping saddle; with power jumper contacts	30 x 67 x 85	289-179	
<b>Interface Module; RJ-45; RJ-45</b>								
		8	1.5 A	Min. cat. 5		20.5 x 51 x 85	289-172	
		10	2.1 A	Min. cat. 5	With power jumper contacts	30 x 51 x 85	289-176	
		10	2.1 A	Min. cat. 5	With power jumper contacts; crossover	30 x 51 x 85	289-177	
<b>Interface Module; RJ-45; IDC; with shield connection</b>								
		8	1.5 A	Min. cat. 6	With shield connection	26.8 x 64.4 x 81.4	289-195	
<b>Potential distribution module</b>								
		Gray	4	1+18	12 A	32 A	≤ 250 VAC/DC	288-837
		<input type="radio"/> Gray <input checked="" type="radio"/> Blue <input type="radio"/> Gray <input type="radio"/> Gray <input checked="" type="radio"/> Blue <input type="radio"/> Gray	1	1+6	65 A	12 A	≤ 250 VAC/DC	830-800/000-302
			1	1+6	65 A	12 A	≤ 250 VAC/DC	830-800/000-302/000-006
			1	1+9	65 A	10 A	≤ 250 VAC/DC	830-800/000-303
			1	1+6	65 A	12 A	≤ 250 VAC/DC	With levers 830-800/000-312
			1	1+6	65 A	12 A	≤ 250 VAC/DC	With levers 830-800/000-312/000-006
			1	1+9	65 A	10 A	≤ 250 VAC/DC	With levers 830-800/000-313
		<input type="radio"/> Gray	2	2+8	30 A	10 A	≤ 250 VAC/DC	830-800/000-305
		<input type="radio"/> Gray	2	2+12	30 A	10 A	≤ 250 VAC/DC	830-800/000-306
		<input type="radio"/> Gray	2	2+16	30 A	10 A	≤ 250 VAC/DC	830-800/000-307
		<input type="radio"/> Gray	2	2+24	30 A	10 A	≤ 250 VAC/DC	830-800/000-308
		<input type="radio"/> Gray	2	2+8	30 A	10 A	≤ 250 VAC/DC	With levers 830-800/000-315
		<input type="radio"/> Gray	2	2+12	30 A	10 A	≤ 250 VAC/DC	With levers 830-800/000-316
		<input type="radio"/> Gray	2	2+16	30 A	10 A	≤ 250 VAC/DC	With levers 830-800/000-317
		<input type="radio"/> Gray	2	2+24	30 A	10 A	≤ 250 VAC/DC	With levers 830-800/000-318
		<input type="radio"/> Gray	2	2+8	30 A	6.3 A	≤ 250 VAC/DC	With lever/fuse 830-800/000-319

# WAGO Mounting Carrier – 288 Series

## For rail mounting PCBs

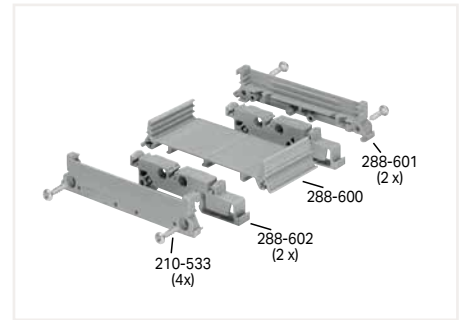
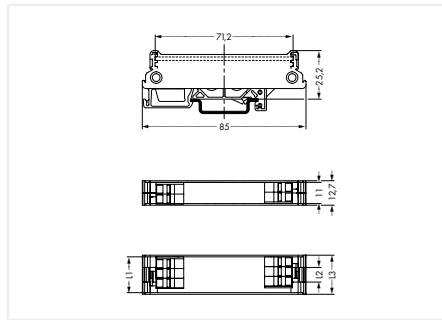

Mounting Carrier, size 1

Length calculation for a complete mounting carrier:

PCB length: L1

Base length: L2 = L1 - 11 mm

Mounting carrier length: L3 = L1 + 2 mm

With size 1 lateral cover, 6.35 mm thick

Free space between base and PCB when using upper PCB groove: 5 mm

PCB tolerances: 1.5 mm ± 0.2 mm (thickness), ± 0.2 mm (length/width), -0.1/+0.3 for milling contours

### Mounting Carrier; size 1

Description	Item No.	Pack. Unit
Lateral Cover; size 1; small; 6.35 mm thick	288-601	1
Foot for DIN-35 Rail	288-602	1
Carrier Base; size 1; 1 m long	288-600	1

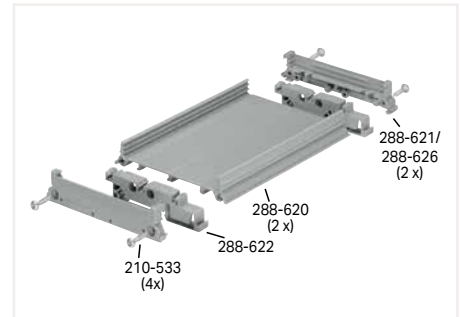
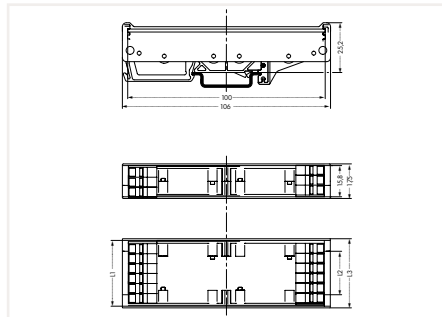

Mounting Carrier, size 2

Length calculation for a complete mounting carrier:

PCB length: L1

Base length: L2 = L1 - 15.8 mm

Mounting carrier length: L3 = L1 + 2 mm

Cover length: L4 = L1

With size 2 lateral cover, 8.75 mm thick

Free space between base and PCB when using upper PCB groove: 5 mm

PCB tolerances: 1.5 mm ± 0.2 mm (thickness), ± 0.2 mm (length/width), -0.1/+0.3 for milling contours

### Mounting Carrier; size 2

Description	Item No.	Pack. Unit
Lateral cover; size 2; 25.2 mm high; 8.75 mm thick	288-621	1
Foot for DIN-35 Rail	288-622	1
Carrier Base; size 2; 1 m long	288-620	1
Lateral cover; size 2; 70 mm high; 8.75 mm thick	288-626	1
Cover; size 2; 1 mm long	288-627	1

10



### Accessories; for All Mounting Carriers

#### Marking Strips



Description	Item No.	Pack. Unit
Phillips Screw, 2.9 x 13	210-533	25
Marking Strip, 7.5 x 0.5 mm; 1 m long; translucent	709-196	1

# WAGO Empty Component Plug Housing; Carrier Terminal Blocks – 2042 / 2002 Series

Illustration	Description	Number of Carrier Terminal Blocks	Item No.	Pack. Unit
<b>Empty component plug for carrier terminal blocks</b>				
	2-pole; 5.2 mm/0.205 inch wide; type 1	1	2002-800	100
	2-pole; 10.4 mm/0.409 inch wide; type 2	1	2002-810	50
	4-pole; 10.4 mm/0.409 inch wide; type 3	2	2002-820	50
	4-pole; transparent housing; with fiber optics; 10.3 mm / 0.406 inch wide	2	2042-321	5
	6-pole; transparent housing; with fiber optics; 15.5 mm / 0.61 inch wide	3	2042-331	5
	8-pole; transparent housing; with fiber optics; 20.7 mm / 0.815 inch wide	4	2042-341	5
	10-pole; transparent housing; with fiber optics; 25.9 mm / 1.02 inch wide	5	2042-351	5

<b>Accessories; item-specific</b>				
Illustration	Description		Item No.	Pack. Unit
	2-Wire Carrier Terminal Block; 2.5 mm <sup>2</sup>		2002-1661	50
	3-Wire Carrier Terminal Block; 2.5 mm <sup>2</sup>		2002-1761	50
	4-Wire Carrier Terminal Block; 2.5 mm <sup>2</sup>		2002-1861	50
	2-Wire Carrier through Terminal Block; with isolation; gray; 2.5 mm <sup>2</sup>		2002-1549	50
	2-Conductor Carrier through Terminal Block; with carrier with grounding foot to the DIN-rail; white; 2.5 mm <sup>2</sup>		2002-1568	50
	End and Intermediate Plate, 1 mm thick; protruding; orange		2002-1594	25

Illustration	Description		Item No.	Pack. Unit
<b>Empty component plug for through terminal blocks</b>				
	2-pole; 10.4 mm/ 0.409 inch wide; type 4	2	2002-880	50

<b>Accessories; item-specific</b>				
Illustration	Description		Item No.	Pack. Unit
	2-Wire Through Terminal Block; 2.5 mm <sup>2</sup>		2002-1201	100
	3-Wire Through Terminal Block; 2.5 mm <sup>2</sup>		2002-1301	100
	4-Wire Through Terminal Block; 2.5 mm <sup>2</sup>		2002-1401	100



Opening cover with operating tool (2.5 mm blade)



Opening cover via multi-purpose operating tool for component plugs



Size comparison



Cutting component to the proper length



Pressing component into plug contact via operating tool

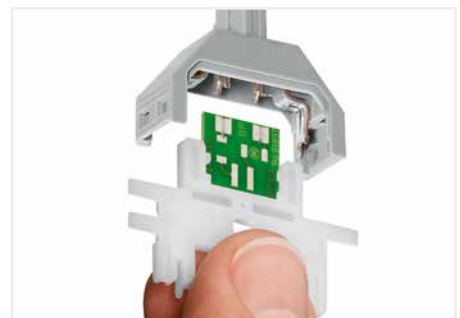

Pushing PCB into plug contact via operating tool

For additional accessories for carrier terminal blocks: see pages 36 ... 38.

Marking: WMB/Marking Strips

# WAGO Smart Data Configuration and Marking Software

**CAD**  
WAGO offers a large number of CAD formats for configuring your design. Use your usual CAD tool to import your configuration from the WAGO Smart Designer configurator.

**Documentation**  
Save time and avoid errors when creating control cabinet documentation – automatically from the WAGO Smart Designer configurator. You benefit from having all the relevant product and process data necessary for standards-compliant documentation.

**Marking**  
Marking control cabinets is easy with the WAGO Smart Printer. Depending on how you work, you have the option of printing markings from different systems.

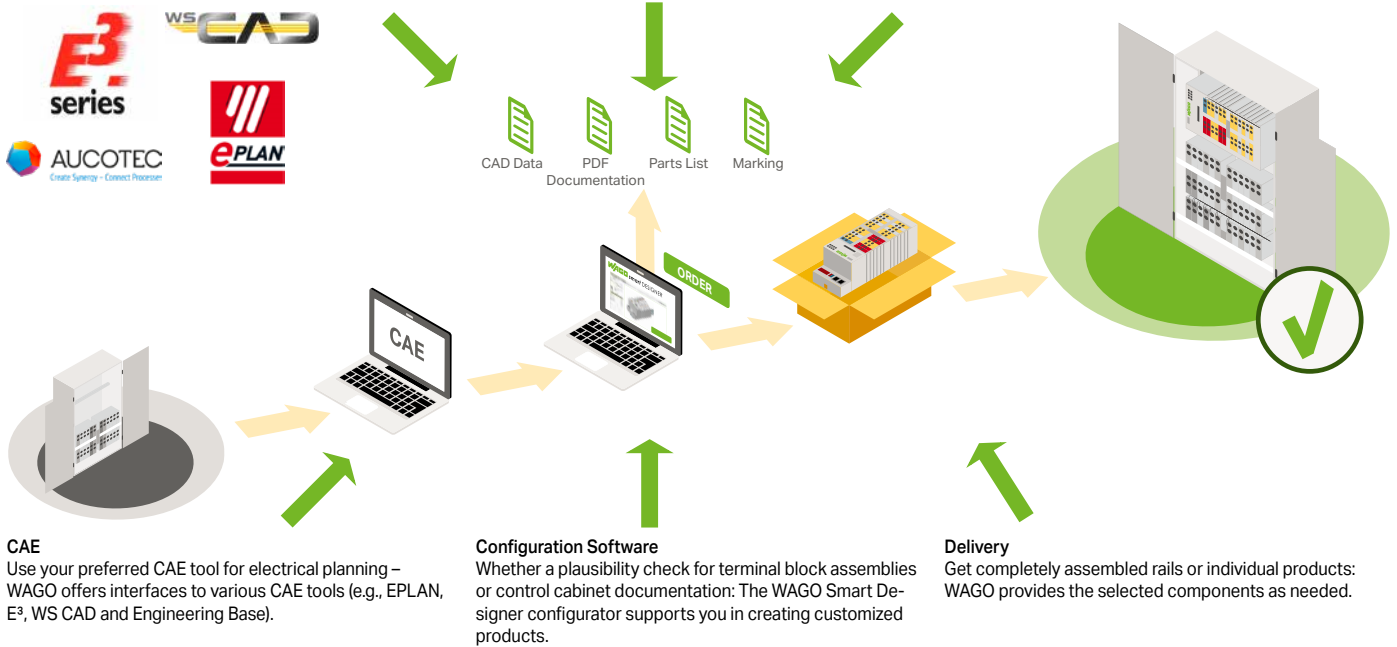

**CAE**  
Use your preferred CAE tool for electrical planning – WAGO offers interfaces to various CAE tools (e.g., EPLAN, E<sup>3</sup>, WS CAD and Engineering Base).

**Configuration Software**  
Whether a plausibility check for terminal block assemblies or control cabinet documentation: The WAGO Smart Designer configurator supports you in creating customized products.

**Delivery**  
Get completely assembled rails or individual products: WAGO provides the selected components as needed.



**WAGO Smart Script Marking Software**  
Smart Script is the software for WAGO's compact thermal transfer Smart Printer. The self-explanatory and intuitive software is perfectly tailored to all control cabinet marking requirements.

Combining superior usability with a modern design, Smart Script helps the user complete the task quickly and easily with just a few clicks. For example, Smart Script can be used to easily customize type labels, as well as to specify and print barcodes and graphic elements.

**Your Benefits:**

- Modern design:  
Appealing and intuitive workflow
- All applications in one software:  
Fast and easy to use, printer driver and all settings integrated
- For all marking tasks in the control cabinet:  
Professional marking of terminal blocks, labels, type plates and conductor markers



**WAGO Smart Designer Configurator**

The software offers a modern and intuitive user interface for maximum usability. In addition, there is better support for mobile devices, expanding the scope of applications and allowing the software to be used at any time and from anywhere. With this future-ready Web application standard, WAGO offers a tool that perfectly supports the engineering process.

The updated tool allows projects from different CAE planning tools to be imported via an interface and a plausibility check to be performed, for example. Based on WAGO's expertise, a check is performed of whether the configured structure is possible and, for rail-mount terminal blocks, the correct jumpers are placed according to the planning. Alternatively, a combination of rail-mount terminal blocks or a custom connector can be created directly in the software, and an offer can be requested with one click.

**Your Benefits:**

- Future-ready Web application standard
- Modern, intuitive user interface
- Print terminal block markings directly with the WAGO Smart Printer



# WAGO Thermal Transfer Smart Printer Usage



Printer – open



Accessories for unwinding material



Open the printer.



Insert the ink ribbon.



Printing 2009-110 Marking Strips on TOPJOB® S Rail-Mount Terminal Blocks with Smart Printer



Prepare the marking material.



Insert and secure the appropriate roller in the printer.



Printer has several interfaces:  
USB, ETHERNET, serial COM port



Fast, cost-effective and easy to use –  
printing WMB Inline markers with Smart Printer

# WAGO Thermal Transfer Smart Printer



- Smart Printer includes:
- Power supply and cable
  - USB cable
  - 1 marking strip reel (2009-110)
  - 1 WMB Inline marker reel (2009-115)
  - 2 rollers (258-5006 + -5007)
  - 1 reel holder
  - 1 ink ribbon (258-5005)

Smart Printer; for WMB Inline markers, marking strips, conductor markers and labels; resolution: 300 dpi

Item No.	Pack. Unit
258-5000	1



### Technical Data

Printing method	Thermal transfer
Print head	Glass layer; spring-mounted
Print speed, max.	127 mm/s (recommended: 50.8 mm/s)
Print width (max.)	46 mm
Print length, max.	762 mm
Print resolution	300 dpi (12 pixels/mm)
See-through/reflective sensor	Yes; centrally mounted
Operating display	Color TFT LCD with navigation button
Memory	8 MB flash; 16 MB SDRAM
Interfaces	USB; RS-232; ETHERNET 10/100 Mbps; USB host
Operating voltage	100 ... 240 VAC, 50 ... 60 Hz (automatic adjustment)
Dimensions (mm) W x H x D	135 x 175 x 245
Weight	2000 g (without printing material)
Operating temperature	5 ... 40 °C (41 ... 104 °F)
Storage temperature	-20 ... 50 °C (-4 ... 122 °F)
Safety approvals	CE (EMC)
Ink ribbon	External reel diameter: 40 mm; internal core diameter: 12.7 mm; max. length: 110 m; max. width: 58 mm

### Accessories

Illustration	Color	Description	Item No.
		Cutter for Smart Printer; not suitable for WMB Inline markers	258-5030
	Gray	Presentation and carrying case for Smart Printer; with foam padding for printer; dimensions (W x H x D): 50 x 26 x 23 cm	258-5015
		Thermal Transfer Ink Ribbon for Smart Printer	
	Black	Suitable for all WAGO marking accessories; width: 50 mm; length: 74 mm	258-5005
	Red	Suitable for all WAGO marking accessories; width: 50 mm; length: 74 mm	258-5005/000-005
	Black	Can only be used for 211-855/-856/-857; 50 mm wide, 74 m long	258-5014
	Black	Roller for marking strips, labels and conductor markers	258-5006
	Green	Roller; for WMB Inline	258-5007
	Blue	Roller; for Mini-WSB Inline	258-5008
	White	Roller; for WMB Inline; for Phoenix Contact rail-mount terminal blocks	258-5009
	Red	Roller; for WMB Inline; for Weidmüller rail-mount terminal blocks	258-5010
	Orange	Roller; for Micro WSB Inline	258-5011

11

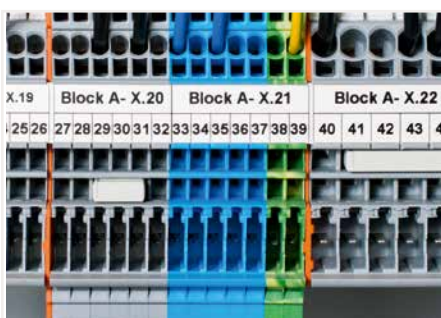

Marking Strips for Rail-Mount Terminal Blocks



Conductor identification



Type Plate

## WMB Inline; Mini-WSB Inline; Micro-WSB Inline; marking strips

For terminal block width: 3.5 mm, 4 ... 4.2 mm and from 5 mm; printing with Smart Printer







Markers; on reel; printing with Smart Printer					
Illustration	Color	WMB Inline; for WAGO rail-mount terminal blocks			Mini-WSB Inline; for WAGO X-COM®-SYSTEM and WAGO I/O System
		2300 markers/reel	2000 markers/reel	1500 markers/reel	1700 markers/reel
		3.5 mm Item No.	4 ... 4.2 mm Item No.	5 ... 5.2 mm Item No.	5 ... 5.2 mm Item No.
	White	2009-113	2009-114	2009-115	2009-145
	Yellow	2009-113/000-002	2009-114/000-002	2009-115/000-002	2009-145/000-002
	Red	2009-113/000-005	2009-114/000-005	2009-115/000-005	2009-145/000-005
	Blue	2009-113/000-006	2009-114/000-006	2009-115/000-006	2009-145/000-006
	Gray	2009-113/000-007	2009-114/000-007	2009-115/000-007	2009-145/000-007
	Orange	2009-113/000-012	2009-114/000-012	2009-115/000-012	2009-145/000-012
	Light green	2009-113/000-017	-	2009-115/000-017	-
	Green	2009-113/000-023	2009-114/000-023	2009-115/000-023	2009-145/000-023
	Violet	2009-113/000-024	2009-114/000-024	2009-115/000-024	2009-145/000-024

Illustration	Color	Description	Item No.
	White	WMB Inline; for Phoenix Contact rail-mount terminal blocks; replaces UC-TM5 and ZB5 markers; 900 markers/reel; 5 ... 5.2 mm	2009-515
	White	WMB Inline for Weidmüller rail-mount terminal blocks, replaces WS 10/5 marker; 1200 markers/reel; 5 ... 5.2 mm	2009-615
	White	Micro-WSB Inline; for 2857, 763 Series; 2000 markers/reel; 4 mm	2009-141

Marking strip; on reel; printing with Smart Printer			
Illustration	Color	Description	Item No.
	White	Marking strip; plain; 11 mm wide; 50 m/reel; for WAGO TOPJOB® S and 285 Series Rail-Mount Terminal Blocks	2009-110
	Translucent	Marking strip; plain; 7.5 mm wide; 50 m/reel; for 270, 862, 869, 870 Series	709-177
	White		709-178
	White	Marking strip; plain; 10 mm wide; 50 m/reel; for 757 Series	757-901/000-050

Marking strip; permanent adhesive; plain; printing with Smart Printer			
Illustration	Color	Description	Item No.
	White	10 mm wide; 20 m/reel	210-870
	Silver		210-871
	White	12.7 mm wide; 20 m/reel; for Siemens ET200	210-880
	Yellow		210-880/000-002
	White	15 mm wide; 50 m/reel	210-702
	White		210-872
	Silver	20 mm wide; 20 m/reel	210-873
	White		210-882
	Yellow	22.6 mm wide; 20 m/reel; for Siemens S7	210-882/000-002
	White		210-874
	Yellow	30 mm wide; 20 m/reel	210-874/000-002
	Silver		210-875
	White	46 mm wide; 20 m/reel	210-876
	Yellow		210-876/000-002
Silver	210-877		

Self-laminating label; printing with Smart Printer			
Illustration	Color	Description	Item No.
	White	Write-on surface: 9 x 18; 1000 per reel	211-855
	White	Write-on surface: 15 x 22; 1000 per reel	211-856
	White	Write-on surface: 18 x 44; 500 per reel	211-857

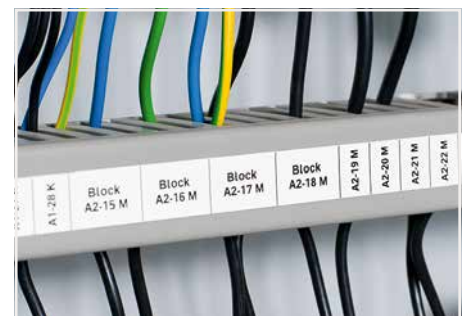

Marking Strips on Cable Duct

# Label; wire markers; shrink tube; type plate

## Printing with Smart Printer

Illustration	Color	Description	Item No.
	<input type="radio"/> White	Wire marker for thread-on mounting; For conductor cross-sections 0.75 ... 1.5 mm <sup>2</sup> ; 1000 per reel	211-861
	<input type="radio"/> White	For conductor cross-sections 2.5 ... 6 mm <sup>2</sup> ; 1000 per reel	211-862
	<input type="radio"/> White	For conductor cross-sections 6 ... 16 mm <sup>2</sup> ; 1000 per reel	211-863
	<input type="radio"/> White	Cable tie marker; 25 x 20 mm; marking area: 25 x 10 mm; 500 per reel	211-835
	<input type="radio"/> White	Cable tie marker; inner wrap (marking area on the inner side); dimensions: 117.5 x 15 mm;	211-836
	<input checked="" type="radio"/> Yellow	marking area: 100 x 15 mm; 800 markers per reel	211-836/000-002
	<input type="radio"/> White	Cable tie marker; marking area: 100 x 15 mm; 500 per reel	211-837
	<input checked="" type="radio"/> Yellow		211-837/000-002
		Shrink tube for conductor marking; 2:1 shrink ratio	
	<input type="radio"/> White	Ø 2.4 mm; for conductor cross-sections 0.25 ... 0.75 mm <sup>2</sup> ; 20 m/reel	211-500
	<input checked="" type="radio"/> Yellow		211-500/000-002
	<input type="radio"/> White	Ø 3.2 mm; for conductor cross-sections 0.75 ... 1 mm <sup>2</sup> ; 20 m/reel	211-501
	<input checked="" type="radio"/> Yellow		211-501/000-002
	<input type="radio"/> White	Ø 4.8 mm; for conductor cross-sections 1 ... 2.5 mm <sup>2</sup> ; 20 m/reel	211-502
	<input checked="" type="radio"/> Yellow		211-502/000-002
	<input type="radio"/> White	Ø 6.4 mm; for conductor cross-sections 4 ... 6 mm <sup>2</sup> ; 20 m/reel	211-503
	<input checked="" type="radio"/> Yellow		211-503/000-002
	<input type="radio"/> White	Ø 9.5 mm; for conductor cross-sections 10 ... 16 mm <sup>2</sup> ; 15 m/reel	211-504
	<input checked="" type="radio"/> Yellow		211-504/000-002
	<input type="radio"/> White	Ø 12.7 mm; for conductor cross-sections 25 ... 35 mm <sup>2</sup> ; 15 m/reel	211-505
<input checked="" type="radio"/> Yellow		211-505/000-002	
<input type="radio"/> White	Ø 19 mm; for conductor cross-sections 35 ... 50 mm <sup>2</sup> ; 15 m/reel	211-506	
<input checked="" type="radio"/> Yellow		211-506/000-002	
		Label roll; self-adhesive; plain;	
	<input type="radio"/> White	15 x 6 mm; 3000 labels/reel	210-805
	<input checked="" type="radio"/> Yellow		210-805/000-002
	<input type="radio"/> White	15 x 9 mm; 3000 labels/reel	210-806
	<input checked="" type="radio"/> Yellow		210-806/000-002
	<input type="radio"/> White	20 x 8 mm; 3000 labels/reel	210-807
	<input checked="" type="radio"/> Yellow		210-807/000-002
	<input type="radio"/> White	9.5 x 25 mm; 1500 labels/reel; 3 lines	210-808
	<input type="radio"/> White	5 x 35 mm; 1500 labels/reel; 1 lines	210-810
	<input type="radio"/> White	Fabric; 20 x 7 mm; 3000 labels/reel	210-811
	<input checked="" type="radio"/> Yellow		210-811/000-002
	<input type="radio"/> White	Continuous label; self-adhesive; plain; 9 lines of 25 m each; 2.3 mm wide	210-831
	<input type="radio"/> White	9 lines of 25 m each; 3 mm wide	210-832
	<input type="radio"/> White	5 lines of 25 m each; 5 mm wide	210-834
	<input checked="" type="radio"/> Yellow	5 lines of 25 m each; 6 mm wide	210-833
	<input type="radio"/> White	Circuit marking label; self-adhesive; plain; divided into two fields; 750 labels/reel; 1 line	210-813
	<input type="radio"/> White	divided into three fields; 750 labels/reel; 1 line	210-814
	<input type="radio"/> White	Void label; 99 x 44 mm; plain; 500 labels/reel	210-824
		Type plate;	
	<input type="radio"/> White	70 x 33 mm; 500 markers/reel	210-801
	<input type="radio"/> Silver		210-802
	<input type="radio"/> White	44 x 99 mm; 500 markers/reel	210-803
	<input type="radio"/> Silver		210-804
<input type="radio"/> Silver	25 x 50 mm; 500 markers/reel	210-812	

11



Self-laminating label



Wire marker for thread-on mounting



Self-adhesive device label

## Sleeve; marker; push-button label Printing with Smart Printer

Illustration	Color	Description	Item No.	PU
	<input type="radio"/> Transparent	Sleeve; 12 mm long; For conductor diameters 1.4 ... 5 mm; halogen-free	211-812	500
	<input type="radio"/> Transparent	For conductor diameters 5 ... 11 mm; halogen-free	211-813	500
	<input type="radio"/> White	Markers; 12 x 4 mm; 2500 markers/reel	211-811	1
		Sleeve; 23 mm long		
	<input type="radio"/> Transparent	For conductor diameters 1.4 ... 5 mm; halogen-free	211-823	500
	<input type="radio"/> Transparent	For conductor diameters 5 ... 11 mm; halogen-free	211-824	200
	<input type="radio"/> Transparent	For wire diameter 1.5 ... 2.5 mm	211-922	1000
	<input type="radio"/> Transparent	For wire diameter 2 ... 4 mm	211-923	500
	<input type="radio"/> Transparent	For wire diameter 4 ... 7 mm	211-924	500
	<input type="radio"/> Transparent	For wire diameter 6 ... 10 mm	211-925	200
	<input type="radio"/> Transparent	For wire diameter 10 ... 14 mm	211-926	200
	<input type="radio"/> Transparent	For wire diameter 14 ... 22 mm	211-927	100
	<input type="radio"/> White	Markers; 23 x 4 mm; 2500 markers/reel	211-821	1
	<input type="radio"/> Transparent	Sleeve; 23 mm long; mounting with cable ties; halogen-free	211-829	500
	<input type="radio"/> White	Markers; 23 x 4 mm; 2500 markers/reel	211-821	1
		Cable tie; 2.5 x 100 mm	807-090/101-100	1
		Push-button label;		
	<input type="radio"/> Silver	27 x 12.5 mm; 350 markers/reel; for Siemens frame; for snap-on or adhesive attachment	210-842	1
	<input type="radio"/> Silver	27 x 17.5 mm; 350 markers/reel; for Siemens frame; for snap-on or adhesive attachment	210-836	1
	<input type="radio"/> Silver	27 x 27 mm; 250 markers/reel; for Siemens frame; for snap-on or adhesive attachment	210-840	1
	<input type="radio"/> Silver	26.5 x 18 mm; 1000 markers/reel; for Eaton	210-850	1
	<input type="radio"/> Silver	27 x 19 mm; 350 markers/reel	210-852	1
	<input type="radio"/> Silver	27 x 18 mm; 350 markers/reel	210-855	1
	<input type="radio"/> Silver	22 x 22 mm; 300 markers/reel	210-847	1
	<input type="radio"/> Silver	27 x 27 mm; 250 markers/reel	210-848	1
	<input type="radio"/> Silver	28 x 28 mm; 500 markers/reel	210-854	1
		Cover;		
	<input type="radio"/> Transparent	27 x 12.5 mm; optional for 210-842 Push-Button Label; for Siemens frame; for snap-on attachment	210-843	100
	<input type="radio"/> Transparent	27 x 17.5 mm; optional for 210-836 Push-Button Label; for Siemens frame; for snap-on attachment	210-837	100
	<input type="radio"/> Transparent	27 x 27 mm; optional for 210-840 Push-Button Label; for Siemens frame; for snap-on attachment	210-841	100
<input type="radio"/> Transparent	26.5 x 18 mm; for mounting the 210-858 Push-Button Label	210-851	100	
	<input checked="" type="radio"/> Black	Universal push-button frame; 27 x 19 mm; for attaching the 210-852 Push-Button Label	210-853	100



Remove the printed marker from the roll.



Slide the marker into the marking sleeve receptacle. Replacing the marker is also possible after the conductor has been terminated.



Push-Button Labels for Various Manufacturers



Compress the sleeve and slide it onto the conductor to be marked.



Universal push-button frame (210-853) for attaching the 210-852 Push-Button Label

# WAGO Multi Marking System (WMB); WAGO Mini Quick Marking System (Mini-WSB) With printing

WMB marker; 10 strips with 10 markers each; for single-deck terminal blocks									
Color	Marking	Horizontal marking				Vertical marking			Pack. Unit
		3.5 mm Item No.	4 ... 4.2 mm Item No.	5 ... 5.2 mm Item No.	5 mm Item No.	4 ... 4.2 mm Item No.	5 ... 5.2 mm Item No.	5 mm Item No.	
○ White	1 ... 10 (10 x)	793-3502	793-4502	793-5502	793-502	793-4602	793-5602	793-602	5
○ White	11 ... 20 (10 x)	793-3503	793-4503	793-5503	793-503	793-4603	793-5603	793-603	5
○ White	21 ... 30 (10 x)	793-3504	793-4504	793-5504	793-504	793-4604	793-5604	793-604	5
○ White	31 ... 40 (10 x)	793-3505	793-4505	793-5505	793-505	793-4605	793-5605	793-605	5
○ White	41 ... 50 (10 x)	793-3506	793-4506	793-5506	793-506	793-4606	793-5606	793-606	5
○ White	1 ... 50 (2 x)	793-3566	793-4566	793-5566	793-566	793-4666	793-5666	793-666	5
○ White	51 ... 100 (2 x)	793-3507	793-4507	793-5507	793-507	793-4607	793-5607	793-607	5
○ White	101 ... 150 (2 x)	793-3508	793-4508	793-5508	793-508	793-4608	793-5608	793-608	5
○ White	1 ... 9 (10 x)	793-3565	793-4565	793-5565	793-565				5
○ White	A, B, P, N, GND, PEN, L1, L2, L3, ground (symbol) (10 x)	793-3545	793-4545	793-5545	793-545	793-4645	793-5645	793-645	5
○ White	R, S, T, U, V, W, X, Y, Z, Mp (10 x)	793-3544	793-4544	793-5544	793-544	793-4644	793-5644	793-644	5
○ White	L1, L2, L3, N, GND, L1, L2, L3, N, GND (10 x)		793-4472	793-5472	793-472	794-4672	794-5672	794-672	5

WMB marker; 10 strips with 10 markers each; for double-deck terminal blocks									
Color	Marking	Horizontal marking				Vertical marking			Pack. Unit
		3.5 mm Item No.	4 ... 4.2 mm Item No.	5 ... 5.2 mm Item No.	5 mm Item No.	4 ... 4.2 mm Item No.	5 ... 5.2 mm Item No.	5 mm Item No.	
○ White	1, 3, 5, ..., 99 and 2, 4, 6, ..., 100 (1 x)	793-3599	793-4599	793-5599	793-599	793-4699	793-5699	793-699	5
○ White	101, 103, 105, ..., 149 and 102, 104, 106, ..., 150 (2 x)					793-4900	793-5900	793-900	5

WMB marker; 10 strips with 10 markers each; for triple-deck terminal blocks									
Color	Marking	Horizontal marking				Vertical marking			Pack. Unit
		3.5 mm Item No.	4 ... 4.2 mm Item No.	5 ... 5.2 mm Item No.	5 mm Item No.	4 ... 4.2 mm Item No.	5 ... 5.2 mm Item No.	5 mm Item No.	
○ White	1, 4, 7, ..., 88 and 2, 5, 8, ..., 89 and 3, 6, 9, ..., 90 and 91, 94, 97, 92, 95, 98, 93, 96, 99, ; (1 x)			794-5557	794-557		794-5657	794-657	5
○ White	100, 103, 106, ..., 187 and 101, 104, 107, ..., 188 and 102, 105, 108, ..., 189 and 190, 193, 196, 191, 194, 197, 192, 195, 198, ; (1 x)			794-5558	794-558		794-5658	794-658	5

Mini-WSB marker; 10 strips with 10 markers each; marker width: 5 mm; horizontal marking							
Color	Marking	Item No.	Pack. Unit	Color	Marking	Item No.	Pack. Unit
○ White	1 ... 10 (10 x)	248-502	5	○ White	1, ,2, ,3, ,4, ,5, ; to 46, ,47, ,48, ,49, ,50, ; (1 x)	264-900	5
○ White	11 ... 20 (10 x)	248-503	5	○ White	L1, L2, L3, N, GND, L1, L2, L3, N, GND (10 x)	248-472	5
○ White	21 ... 30 (10 x)	248-504	5	○ White	U, V, W, N, GND, U, V, W, N, GND (10 x)	248-474	5
○ White	31 ... 40 (10 x)	248-505	5	○ White	- (100 x)	247-507	5
○ White	41 ... 50 (10 x)	248-506	5	○ White	+ (100 x)	247-509	5
○ White	1 ... 50 (2 x)	248-566	5	○ White	GND (100 x)	248-578	5



WMB marker card with 10 strips with 10 markers each and horizontal marking



Snapping a WMB marking strip into the marker slot

Item no. suffixes For color markers	
Color	Item No.
● Yellow	.../000-002
● Red	.../000-005
● Blue	.../000-006
● Gray	.../000-007
● Orange	.../000-012
● Light green	.../000-017
● Green	.../000-023
● Violet	.../000-024







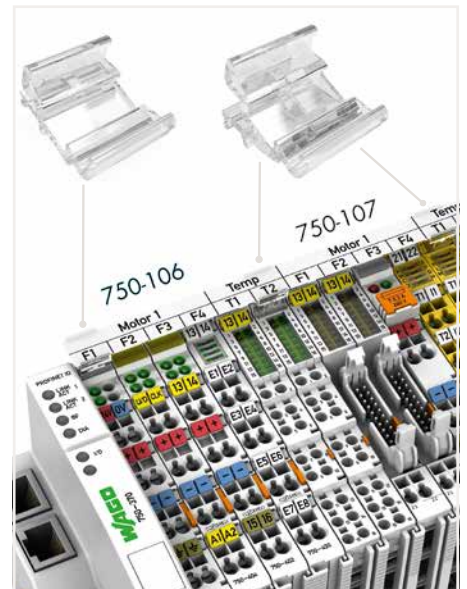







11

## Maker adapter/carrier; group marker carrier

Illustration	Description	Item No.	Pack. Unit
	Group marker carrier; for WAGO TOPJOB® S Rail-Mount Terminal Blocks; snaps into the jumper slot; gray		
	Width: 5 mm; for WMB markers or marking strips	2009-191	50
	Width: 10 mm; for WMB markers or marking strips	2009-192	50
	Width: 10 mm; for marking strips	2009-196	50
	Width: 15 mm; for WMB markers or marking strips	2009-193	50
	Marker carrier; for WAGO TOPJOB® S Rail-Mount Terminal Blocks; for lateral marker slots; gray; width: 5 mm	2009-198	200
	Marker carrier; for WAGO TOPJOB® S Rail-Mount Terminal Blocks; gray		
	For 2002 Series jumper slots	2002-161	100
	For jumper slots of 2002 Series Double-Deck, Double-Disconnect Terminal Blocks	2002-160	50
	Double-deck marker carrier; pivoting; for 2000 Series Double-Deck Terminal Blocks without marker carrier	2000-121	50
	Double-deck marker carrier; pivoting; for 2002 Series Double-Deck Terminal Blocks without marker carrier	2002-121	50
	Triple-deck marker carrier; pivoting; for 2002 Series Triple-Deck Terminal Blocks without marking adapter	2002-131	50
	Group marker carrier; for insertion into the jumper slot of rail-mount terminal blocks		
	For terminal block width 4 ... 6 mm; for up to 3 WMB markers; width: 15 mm	209-140	50
	For up to 2 WMB markers; width: 10 mm	209-141	50
	For up to 1 WMB marker; width: 5 mm	209-142	50
	Group marker carrier; for WMB/Mini-WSB marker slots; 10 mm; white	209-145	100
	Group marker carrier; snaps into end stops (249-116 and 249-117); gray		
	Adjustable height: 43.5 ... 59.5; for 1 marker or self-adhesive label; width: 10 mm	249-119	50
	Adjust height: 43.5 ... 59.5; for 2 WMB markers; width: 10 mm	249-118	100
	Adjustable height: 42.2 ... 58.2; with marking surface; width: 6 mm	249-120	50
	Adjustable height: 45 ... 61; for 9 WMB markers or 1 TOPJOB® S marking strip; width: 12.2 mm	2009-163	50
	Marker carrier for 750/753 Series; folding	750-103	50
	Marker carrier; for 750/753 Series; for use in the upper Mini WSB slot; transparent		
	For I/O module housing with up to 4 LEDs and for the 48 mm I/O module housing	750-106	50
	For I/O module housing with up to 8 or 16 LEDs	750-107	50
	Marker carrier; for 35/50/95 mm² (2, 2/0, 4/0 AWG) POWER CAGE CLAMP; for 2009-110 Marking Strips	285-442	25



## DIN-rail; end stop; collective carrier for jumpers; control cabinet socket/drawer; cover

Illustration	Description	Item No.	Pack. Unit
	Steel DIN-rail; I <sub>N</sub> 57 A (based on 1 m length); slotted; 15 x 5.5 mm; 1 mm thick; 2 m long; per EN 60715	210-111	10
	Steel DIN-rail; I <sub>N</sub> 76 A (based on 1 m length); 35 x 7.5 mm; 1 mm thick; 2 m long; per EN 60715		
	Unslotted	210-113	10
	Slotted; hole width: 25 mm; hole spacing: 36 mm	210-112	10
	Slotted; hole width: 18 mm; hole spacing: 25 mm	210-115	1
	Aluminum DIN-rail; unslotted; I <sub>N</sub> 76 A (based on 1 m length); unslotted; 35 x 8.2 mm; 1.6 mm thick; 2 m long similar to EN 60715	210-196	20
	Stainless steel DIN-rail; I <sub>N</sub> 41 A; max. 6 mm <sup>2</sup> ground conductor terminal block; slotted; 35 x 7.5 mm; 1 mm thick; 2 m long; per EN 60715	210-522	1
	Steel DIN-rail; I <sub>N</sub> 125 A (based on 1 m length); 35 x 15 mm; 2 m long; per EN 60715		
	Slotted; 1 mm thick	210-114	10
	Unslotted; 1 mm thick	210-197	10
	Unslotted; 2.3 mm thick	210-118	10
	Copper DIN-rail; I <sub>N</sub> 309 A (based on 1 m length); unslotted; 35 x 15 mm; 2.3 mm thick; 2 m long; per EN 60715	210-198	10
	Plastic DIN-rail; unslotted; 35 x 15 mm; 2 m long; light gray	210-509	10
	Not suited for use with ground conductor terminal blocks!		
	Screwless end stop		
	For DIN-15 rail; width: 6 mm	249-101	25
	For DIN-35 rail; width: 6 mm	249-116	25
	For DIN-35 rail; width: 10 mm	249-117	25
	For DIN-35 rail; width: 14 mm	249-197	10
	Rail end cap; for 210-113/-112/-115	209-109	25
	Collective carrier for adjacent jumpers; suitable for 279-284 Series Adjacent Jumpers and 215 Series Banana Plugs	209-100	50
	Collective carrier for jumpers; suitable for 282-432 ... -440 Series jumpers	282-369	25
	Collective carrier for jumpers; suitable for TOPJOB® S jumpers	2009-180	50
	Control cabinet outlet; for DIN-35 rail and screw mounting; for plug type F, CEE 7/4 (SCHUKO®)		
	○ Light gray	709-581	1
	● Signal yellow	709-582	1
	● Red	709-583	1
	Switchgear cabinet drawer; DIN-35 snap-on rail-mount drawer	709-591	1
	Cover; type 1; 1 m long; transparent	709-153	10
	Cover carrier; type 1; incl. mounting/securing screws and knurled nut; suitable for 279 to 282 and 880 Series Rail-Mount Terminal Blocks; suitable for 264 Series Mini Rail-Mount Terminal Blocks; suitable for 270 Series Sensor and Actuator Blocks	709-167	10
	Cover; type 2; 1 m long; transparent	709-154	10
	Cover carrier; type 2; incl. mounting/securing screws and knurled nut; suitable for 283 to 285 Series Rail Mount Terminal Blocks; suitable for 279 to 281 Series Double- and Triple-Deck Terminal Blocks; suitable for TOPJOB® 780 to 785 and 775 Series Rail-Mount Terminal Blocks; suitable for 280 Series Sensor/Actuator Terminal Blocks; suitable for 282 Series Disconnect/Test Terminal Blocks for transformer circuits	709-168	10
	Cover; type 3; 1 m long; transparent	709-156	10
	Cover carrier; type 3; for 2000 to 2016 Series, 2102 to 2116 Series and 2200 to 2216 Series Rail-Mount Terminal Blocks; for 2007 Series Transformer Terminal Blocks	709-169	10
	Marking strips; for cover; for laser printers; 6 strips on DIN A4 carrier card	709-183	1



## Operating tools

Illustration	Description	Item No.
	Operating tool with a partially insulated shaft; type 1; (2.5 x 0.4) mm blade	210-719
	Operating tool with a partially insulated shaft; type 2; (3.5 x 0.5) mm blade	210-720
	Operating tool with a partially insulated shaft; type 3; (5.5 x 0.8) mm blade	210-721
	Operating tool set (one of each: 210-719 / 210-720 / 210-721)	210-722
	Operating tool; blades: 3.5 mm and 2.5 mm; for TOPJOB® S Installation Terminal Blocks	2009-309
	Operating tool; blades: 3.5 mm and 5.5 mm; for TOPJOB® S Installation Terminal Blocks	2009-310
	Operating tool with a partially insulated shaft; (2.5 x 0.4) mm blade; short	210-647
	Operating tool with a partially insulated shaft; (2.5 x 0.4) mm blade; angled	210-648
	Operating tool with a partially insulated shaft; (3.5 x 0.5) mm blade; short	210-657
	Operating tool with a partially insulated shaft; (3.5 x 0.5) mm blade; angled	210-658
	Operating tool; insulated; for 279 Series	
	1-way	209-129
	2-way	279-432
	3-way	279-433
	10-way	279-440
	Operating tool; insulated; for 264 Series (1- and 2-way only), 280, 281 Series (up to 3-way only)	
	1-way	209-130
	2-way	280-432
	3-way	280-433
	10-way	280-440
	Operating tool; insulated; 5-way; for 281 Series	281-440
	T-wrench with a partially insulated shaft; for 285 Series	285-172
	T-wrench with a partially insulated shaft and with anti-reverse mating protection; 285 Series	285-173
	Operating pliers; for 279, 280 Series (side-entry wiring)	210-143
	Operating pliers; for 281, 282, 283, 284 Series (side-entry wiring)	210-141



Application example:  
Here with type 1 cover, with safety warning on marking strip (709-183)



Commoning front-entry disconnect terminal blocks via comb-style jumper bar using a 10-pole operating tool

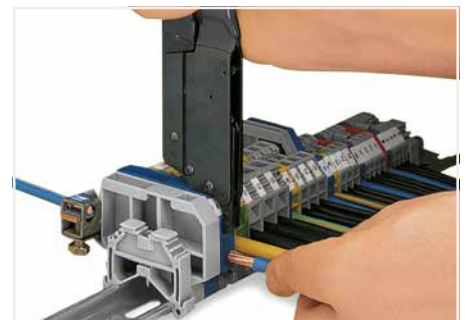

Insert the fixed peg into the upper operating slot, then hook the movable clamp into the lateral operating slot. The contact is fully opened by pressing the handles together until they engage.

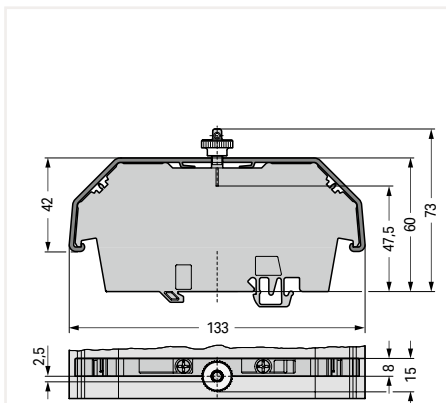

Cover, type 1 (dimensions in mm)

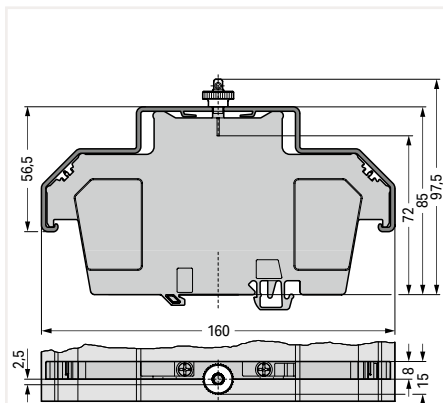

Cover, type 2 (dimensions in mm)

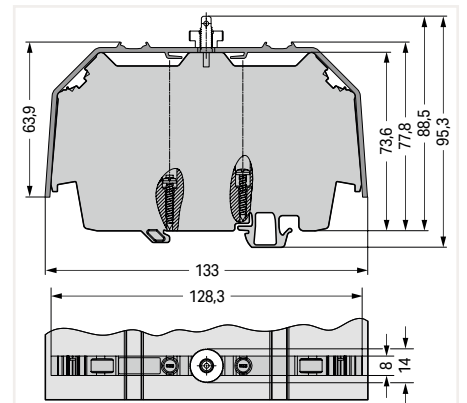

Cover, type 3 (dimensions in mm)

# Cable cutter; wire stripper; cable knife; crimping tool; ferrules







Illustration	Description	Item No.
	Cable cutter; for copper and aluminum cables up to 35 mm <sup>2</sup> (2 AWG)	206-118
	Quickstrip Vario Wire stripper; 0.03 ... 16 mm <sup>2</sup> / 34 ... 6 AWG; with wire cutter	206-1125
	Stripping pliers; for sensor cables; for Ø 3.2 ... 4.4 mm / 0.13 ... 0.17 inch	206-1481
	Stripping pliers; for control cables; for Ø 4.4 ... 7 mm / 0.17 ... 0.27 inch	206-1482
	Cable knife; for Ø 8 ... 28 mm / 0.31 ... 1.1 inch; with a unique changeable cable bracket system; including cable bracket	206-1403
	Cable knife set; for Ø 4 ... 70 mm / 0.16 ... 2.75 inch; including all cable brackets in a Sortimo® Box	206-1400
	Universal cable stripper; for Ø 8 ... 13 mm / 5/16 ... 1/2 inch	206-1442
	In-socket cable stripper; for Ø 8 ... 13 mm / 5/16 ... 1/2 inch	206-1441
	Data cable stripper; for Ø 4.5 ... 10 mm (3/16 ... 3/8 in.)	206-1451
	Variocrimp 4 crimping tool; crimping range: 0.25 ... 4 mm <sup>2</sup> (24 ... 12 AWG)	206-1204
	Variocrimp 16 crimping tool; crimping range: 6 mm <sup>2</sup> (10 AWG), 10 mm <sup>2</sup> (8 AWG) and 16 mm <sup>2</sup> (6 AWG)	206-1216
	Variocrimp 25 crimping tool; crimping range: 10 mm <sup>2</sup> (8 AWG), 16 mm <sup>2</sup> (6 AWG) and 25 mm <sup>2</sup> (4 AWG)	206-1225
	Variocrimp 50 crimping tool; crimping range: 35 mm <sup>2</sup> (2 AWG) and 50 mm <sup>2</sup> (1/0 AWG)	206-1250

Illustration	Sleeve for mm <sup>2</sup>	AWG	Color Code	Strip Length mm	L	L1	D mm	D1	D2	Item No.	Pack. Unit
<b>Ferrule; with plastic collar; electro-tin-plated; electrolytic copper; gastight crimp; per DIN 46288 (Part 4/09.09)</b>											
	0,25	24	●	7	10	6	2,3	1,8	0,85	216-321	1000
	0,25	24	●	9	12	8	2,3	1,8	0,85	216-301	1000
	0,34	22	●	7	10	6	2,5	2	0,85	216-322	1000
	0,34	22	●	9	12	8	2,5	2	0,85	216-302	1000
	0,5	20	○	7	12	6	3,1	2,6	1	216-221	1000
	0,5	20	○	9	14	8	3,1	2,6	1	216-201	1000
	0,75	18	○	8	12	6	3,3	2,8	1,2	216-222	1000
	0,75	18	○	10	14	8	3,3	2,8	1,2	216-202	1000
	1	18	●	8	12	6	3,5	3	1,4	216-223	1000
	1	18	●	10	14	8	3,5	3	1,4	216-203	1000
	1,5	16	●	8	12	6	4	3,5	1,7	216-224	1000
	1,5	16	●	10	14	8	4	3,5	1,7	216-204	1000
	2,08	14	●	10	15	8	4,8	4,2	2,05	216-205	1000
	2,5	14	●	10	15	8	4,7	4,2	2,2	216-206	1000
	4	12	○	12	18	10	5,4	4,8	2,8	216-207	1000
	6	10	●	14	20	12	6,9	6,3	3,5	216-208	1000
	10	8	●	16	22	12	8,4	7,6	4,6	216-209	1000
	16	6	●	23	28	18	9,6	8,8	5,8	216-210	500
<b>Twin ferrule; with plastic collar; extra long for TOBJOB® S Terminal Blocks</b>											
	2 x 0.5	2 x 20	○	12	18	12	3.5 x 2	2.9 x 1.4	1.4	216-540	500
	2 x 1.0	2 x 18	●	14	21	14	5.8 x 3.2	5.2 x 2.6	2	216-552	500
	2 x 1.5	2 x 16	●	18	26	18	6.5 x 3.6	5.9 x 3	2.2	216-573	100
	2 x 2.5	2 x 14	●	18	27	18	8.0 x 4.5	7.2 x 3.7	2.8	216-575	100
	2 x 6.0	2 x 10	●	18	29	18	11.4 x 6.2	10.4 x 5.2	4.5	216-577	100
	2 x 10	2 x 8	●	18	30	18	13.4 x 7.6	12.4 x 6.6	5.8	216-578	100
	2 x 16	2 x 6	●	25	38	25	17.2 x 9.5	16 x 8.3	8.3	216-599	50
<b>Ferrule; without plastic collar; electro-tin-plated; electrolytic copper; gastight crimp; per DIN 46288 (Part 4/09.09)</b>											
	0,25	24		7	7		1,7		0,75	216-131	5000
	0,34	22		7	7		1,8		0,85	216-132	5000
	0,5	20		8	8		2,1		1	216-101	5000
	0,75	18		8	8		2,3		1,2	216-102	5000
	1	18		8	8		2,5		1,4	216-103	5000
	1,5	16		8	8		2,8		1,7	216-104	5000
	2,5	14		10	10		3,4		2,2	216-106	5000
	4	12		10	10		4		2,8	216-107	5000
	6	10		12	12		4,7		3,5	216-108	1000
	10	8		12	12		5,8		4,5	216-109	1000
	16	6		15	15		7,5		5,8	216-110	500
	25	4		25	25		9,5		7,3	216-413	50
	35	2		25	25		11		8,3	216-414	50
	35	2		30	30		11		8,3	216-424	50
	50	1/0		30	30		13		10,3	216-425	50
	50	1/0		35	35		13		10,3	216-435	50

Ferrules for TOPJOB® S; see page 39

11

## Test and measurement devices; test plug; banana plug

Illustration	Description	Item No.	Pack. Unit
	Profi-LCD+; 2-pole voltage tester with LCD display; removable 4 mm Ø test probes	206-707	1
	Profi-LED+; 2-pole voltage tester with LED display; removable 4 mm Ø test probes	206-706	1
	Spare test probes; 4 mm Ø (2 pieces)	206-808	1
	Testboy; non-contact voltage tester; with integrated flashlight; voltage range: 12 ... 1000 VAC	206-804	1
	● Test plug; cable length: 500 mm; max. 42 V; Ø 2 mm; red	210-136	50
	● Test plug; cable length: 500 mm; max. 42 V; Ø 2.3 mm; yellow	210-137	50
	● Step-down test plug; from 4 mm socket to 2 mm plug; red	210-297	100
	Test pin; with solder connection for test cable; Ø 1 mm	735-500	100
	Banana plug; for 4 mm socket diameter; color mixed; 10 of each of: orange, white, black, blue, yellow	215-111	50
	● Orange	215-211	50
	● Red	215-212	50
	● Black	215-311	50
	● Green	215-411	50
	● Yellow	215-511	50
	○ White	215-611	50
	● Blue	215-711	50
	○ Gray	215-811	50
	● Green-yellow	215-911	50
	Test plug module; for testing without connected conductor; with 10 mm contact lug; for 236 Series; snaps together		
	○ Gray; pin spacing: 5 / 0.197 inch	231-127	100
	● Orange; pin spacing: 5.08 / 0.2 inch	231-128	100
	○ Gray; pin spacing: 7.5 / 0.295 inch	231-161	100
	● Orange; pin spacing: 7.62 / 0.3 inch	231-125	100
	Test plug module; for testing with connected conductor; with 17 mm contact lug; for 280, 736, 737, 738, 780 Series; snaps together		
	○ Gray; pin spacing: 5 mm / 0.197 inch	231-126	100
	● Orange; pin spacing: 5.08 mm / 0.2 inch	231-426	100
	Test plug module; for testing with connected conductor; with 18 mm contact lug; for 280, 736, 737, 738, 780 Series; snaps together		
	○ Gray; pin spacing: 5 / 0.197 inch	231-155	100
● Orange; pin spacing: 5.08 / 0.2 inch	231-455	100	
○ Gray; pin spacing: 7.5 / 0.295 inch	231-456	100	
End plate; gray	231-100	200	
End plate; orange	231-300	200	



Partially stripping a conductor

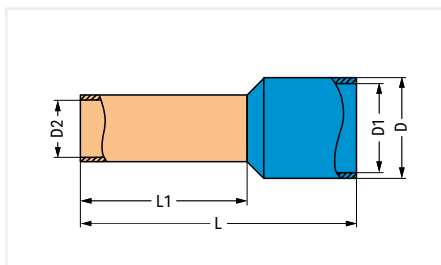











Insert the ferruled conductor into the crimping station.



## International Certification Organizations – Overview

		Abbreviation			Abbreviation
	Underwriters Laboratories USA <a href="http://www.ul.com">http://www.ul.com</a>	UL		Danmarks Elektriske Materielkontrol Denmark <a href="http://www.demko.dk">http://www.demko.dk</a>	DEMKO
	Underwriters Laboratories USA <a href="http://www.ul.com">http://www.ul.com</a>	UL	CCA 	CENELEC CERTIFICATION AGREEMENT Danmarks Elektriske Materielkontrol Denmark <a href="http://www.cenelec.org">http://www.cenelec.org</a>	CCA Zul.-Nr. mit NL
	Underwriters Laboratories USA <a href="http://www.ul.com">http://www.ul.com</a>	cURus			
	Underwriters Laboratories USA <a href="http://www.ul.com">http://www.ul.com</a>	cULus		SETI – FEMKO Sähkötarastuskeskus Elinspek- tionscentralen Finland <a href="http://www.seti.fi">http://www.seti.fi</a>	
	Canadian Standards Association Canada <a href="http://www.csa.ca">http://www.csa.ca</a>	CSA		Sähkötarastuskeskus Elinspek- tionscentralen Finland <a href="http://www.fimko.com">http://www.fimko.com</a>	FIMKO
	VDE-Gutachten mit Fertigungsüber- wachung Germany <a href="http://www.vde.de/vde/html/e/home.htm">http://www.vde.de/vde/html/e/home.htm</a>	VDE		South African Bureau of Standards South Africa <a href="http://www.sabs.co.za">http://www.sabs.co.za</a>	SABS
	VDE – Deutscher Verband für Elek- trotechnik Germany <a href="http://www.vde.de">http://www.vde.de</a>				
VDE	VDE – Prüfbericht Germany			RosTesT Russia <a href="http://www.rostest.ru">http://www.rostest.ru</a>	ROTEST
	Österreichischer Verband für Elek- trotechnik Austria <a href="http://www.ove.at">http://www.ove.at</a>	ÖVE		Departamentul Moldovastandard Moldova <a href="http://www.moldova.md/ro/government/oil/D_STAND/en/strcent2.htm">http://www.moldova.md/ro/govern- ment/oil/ D_STAND/en/strcent2.htm</a>	CSM
	Schweizerischer Elektrotechnischer Verein Switzerland <a href="http://www.sev.ch/">http://www.sev.ch/</a>	SEV		Certificate of Registration Great Britain <a href="http://www.astacertification.com">http://www.astacertification.com</a>	ASTA
	N.V. tot Keuring van Elektrotech- nische Materialen Netherlands <a href="http://www.kema.nl">http://www.kema.nl</a>	KEMA		Rheinisch-Westfälischer Technischer Überwachungsverein e.V. Germany <a href="http://www.rwtuv.de">http://www.rwtuv.de</a>	RWTÜV
CCA	CENELEC CERTIFICATION AGREEMENT N.V. tot Keuring van Elektrotech- nische Materialen Netherlands <a href="http://www.cenelec.org">http://www.cenelec.org</a>	CCA Zul.-Nr. mit NL		Elektrotechnický výskumný a projektový ústav Czech Republic <a href="http://www.ezu.cz">http://www.ezu.cz</a>	EZU
				Stowarzyszenie Elektryków Polskich Poland <a href="http://www.sep.com.pl">http://www.sep.com.pl</a>	BBJ
	Norges Elektriske Materialkontroll Norway <a href="http://express.nemko.com">http://express.nemko.com</a>	NEMKO		Stowarzyszenie Elektryków Polskich Poland <a href="http://www.bbj.pl">http://www.bbj.pl</a>	SEP
	Svenska Elektriska Materielkontrol- lanstalten AB Sweden <a href="http://www.semko.com">http://www.semko.com</a>	SEMKO			

		Abbreviation			Abbreviation
<b>CNET</b>	Centre National d'Etudes des Télécommunications France <a href="http://www.lannion.cnet.fr">http://www.lannion.cnet.fr</a>	CNET		Robbanásbiztos Villamos Berendezések Hungary <a href="http://www.bki.hu">http://www.bki.hu</a>	BKI
<b>LCIE</b>	Laboratoire Central des Industries Electriques France <a href="http://www.lcie.fr">http://www.lcie.fr</a>	LCIE	<b>CB</b>	CB – TEST CERTIFICATE India <a href="http://www.ul-europe.com">http://www.ul-europe.com</a>	CB
			<b>CB</b>	CB – TEST CERTIFICATE China <a href="http://www.ul-europe.com">http://www.ul-europe.com</a>	CB
	Fyzikálne Technické úzkusební Ústav, Ostrava-Radvanice Czech Republic <a href="http://www.ftzu.cz">http://www.ftzu.cz</a>	FTZU		<a href="http://www.enec.com">http://www.enec.com</a>	ENEC
<b>Marine Approvals</b>			<b>EX Approvals</b>		
<b>BV</b>	Bureau Veritas France <a href="http://www.bureauveritas.fr">http://www.bureauveritas.fr</a>	BV		Physikalisch Technische Bundesanstalt Germany <a href="http://www.ptb.de">http://www.ptb.de</a>	PTB
	Lloyd's Register of Shipping Great Britain <a href="http://www.lloydsregister.com">http://www.lloydsregister.com</a>	LR		Underwriters Laboratories USA <a href="http://www.ul.com">http://www.ul.com</a>	AEx
	NV – Det Norske Veritas Norway <a href="http://www.dnvgl.com">http://www.dnvgl.com</a>	DNV-GL			
	Russian Maritime Register of Shipping GUS <a href="http://www.rs-head.spb.ru">http://www.rs-head.spb.ru</a>	RMR			
	Polski Rejestr Statków Poland <a href="http://www.prs.pl">http://www.prs.pl</a>	PRS			
	Korean Register of Shipping Korea <a href="http://www.krs.co.kr">http://www.krs.co.kr</a>	KR			
<b>ABS</b>	American Bureau of Shipping USA <a href="http://www.eagle.org">http://www.eagle.org</a>	ABS			

# Current-Carrying Capacity Curves for Automotive Fuses; Current-Carrying Capacity Curve for X-COM®-SYSTEM

## Current-Carrying Capacity Curves for Automotive Fuses

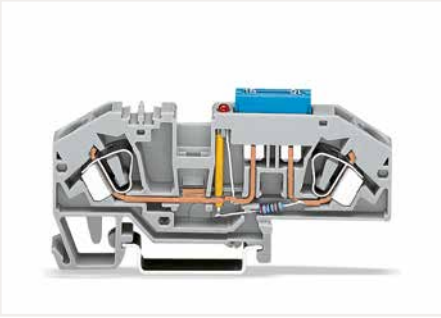

Nominal current ratings for fuse cartridges are defined differently in international standards. This is why the recommended continuous current-carrying capacity of the fuses is a max. 80 % of their nominal current according to DIN 72581/Part 3 (at a surrounding air temperature of 23 °C). Selecting the correct fuse cartridge is important for product safety within applications, as well as for fuse cartridge service life and reliability. Fuse cartridges will only operate perfectly as protection components (break-off point) if they are properly selected and used as intended (i.e., according to the most current and valid specifications, as well as data sheet characteristics), according to basic safety requirements (i.e., persons, animals and property must be protected against hazards).

### Information from the mini-automotive, blade-type fuse manufacturers

Derating T <sub>amb</sub> / °C	%	F <sub>T</sub>
-25	14	0.877
-20	13	0.885
-15	12	0.893
-10	11	0.901
- 5	10	0.909
0	9	0.917
5	8	0.926
10	6	0.943
15	4	0.962
20	2	0.980
23	0	1.000
30	- 2	1.020
35	- 4	1.042
40	- 6	1.064
45	- 8	1.087
50	-10	1.111
55	-13	1.149
60	-16	1.190
65	-19	1.235
70	-22	1.282

Concerning product safety, fuse cartridges must generally be tested under both normal and faulty operating conditions within your application.

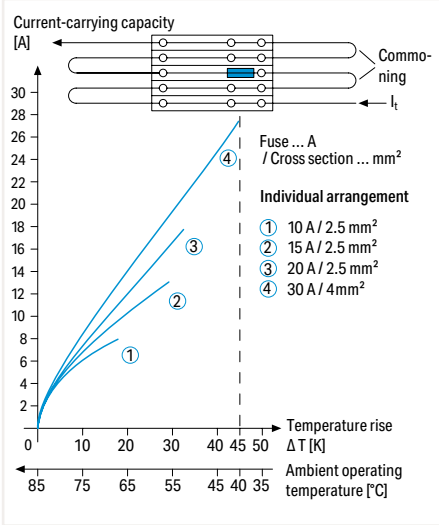

Application Notes for Use of Fuse Terminal Blocks  
Diagram: Individual Arrangement

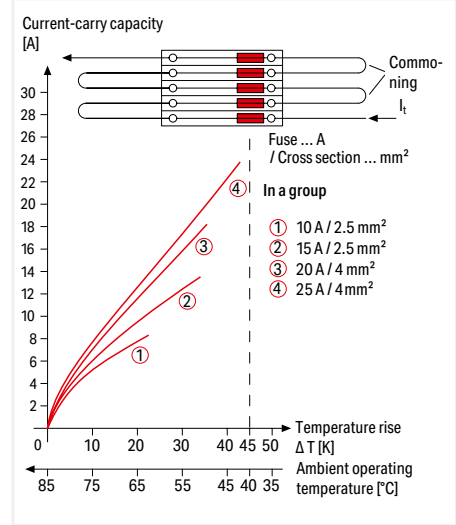

Application Notes for Use of Fuse Terminal Blocks  
Diagram: Block Arrangement

## Current-carrying capacity curve for X-COM®-SYSTEM 1-conductor/1-pin and 2-pin carrier terminal blocks and 1-conductor female connectors; per IEC/EN 60512-5-2

Both the design requirements and the current-carrying capacity of a connector must be checked by the user when selecting connectors. The function of a current-carrying capacity curve per EN 60512-5-2 is shown by an application using a current-carrying capacity curve for the X-COM®-SYSTEM:

This application requires each pole of a 4-pole connector be subjected to a load of 32 A. The basic curve determined for this pole number with a conductor cross-section of 4 mm<sup>2</sup> shows that this is possible up to a surrounding air temperature of 42 °C (107.6 °F). The current must be reduced at higher surrounding air temperatures, e.g., to 19 A at a surrounding air temperature of 80 °C (176 °F).

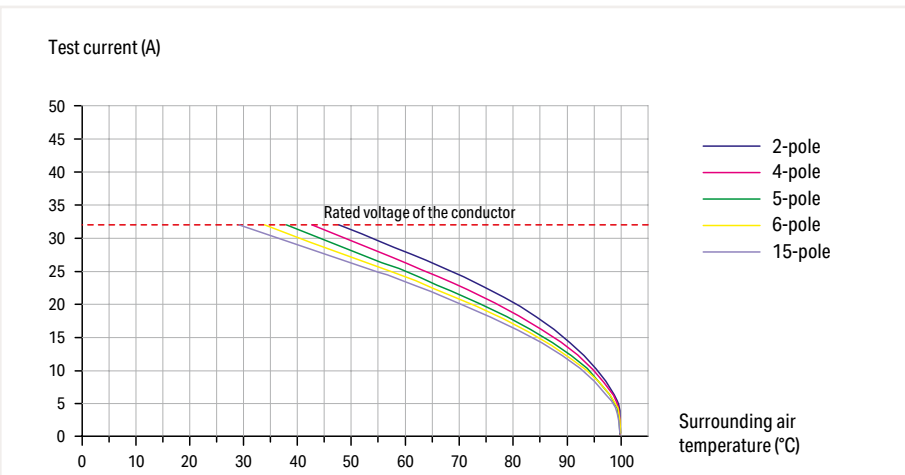

1-conductor/1-pin carrier terminal block, 769-176  
Conductor cross-section: 4 mm<sup>2</sup> (12 AWG)

1-conductor female plugs, 769-102 to 769-115  
Conductor cross-section: 4 mm<sup>2</sup> (12 AWG)  
Conductor loop length: 1 m

# Current-Carrying Capacity Curves for Connectors with CAGE CLAMP® MULTI CONNECTION SYSTEM (MCS) MIDI

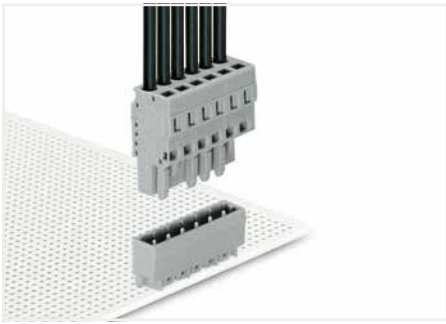

**Male headers with solder pins**

1 mm x 1 mm	231-132/001-000 ... 231-154/001-000
1.2 mm x 1.2 mm	231-162/001-000 ... 231-184/001-000

**Female connectors** 231-102/026-000 ... 231-124/026-000

**Conductor cross-section:** PCB side commoned with 2.5 mm<sup>2</sup>  
2.5 mm<sup>2</sup> "f"

**Conductor loop length** 1 m

Additional current-carrying capacity curves upon request.

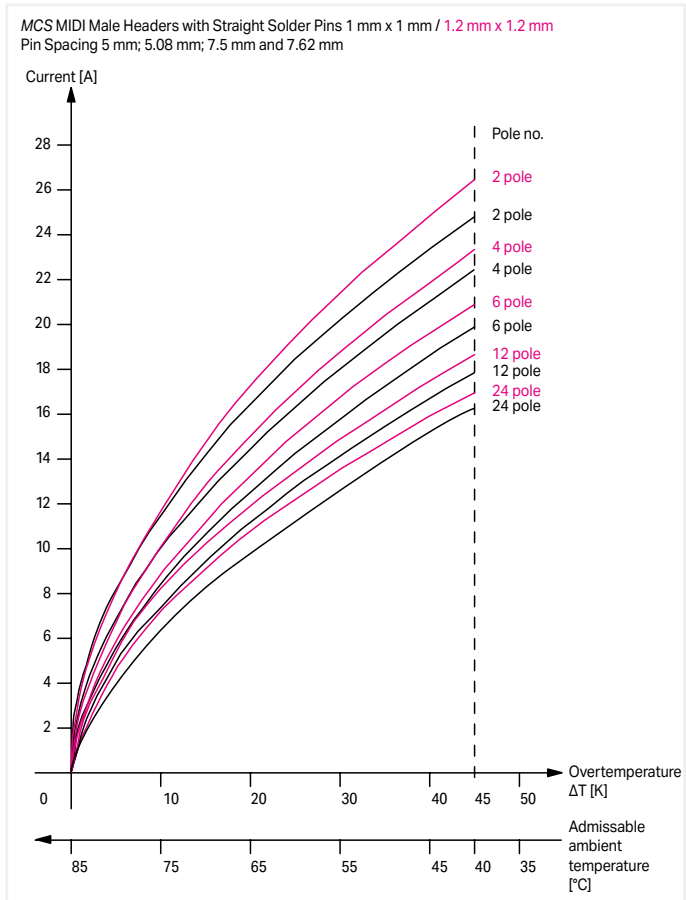

## Determining Maximum Load

Explanation using the following example:

What load in amps can a 6-pole connector assembly handle when subjected to a surrounding air temperature of 55 °C?

1. On the lower axis (x-axis = temperature), select the surrounding air temperature for the connector assembly (here 55 °C).
2. For this temperature, draw a vertical line up to the curve corresponding to the number of poles (here 6-pole).
3. From the point of intersection, draw a line horizontally to the intersection with the y-axis and read the value of the current.

In this example, all poles of the 6-pole connector assembly can be simultaneously loaded with 4.8 A at a 55 °C surrounding air temperature.

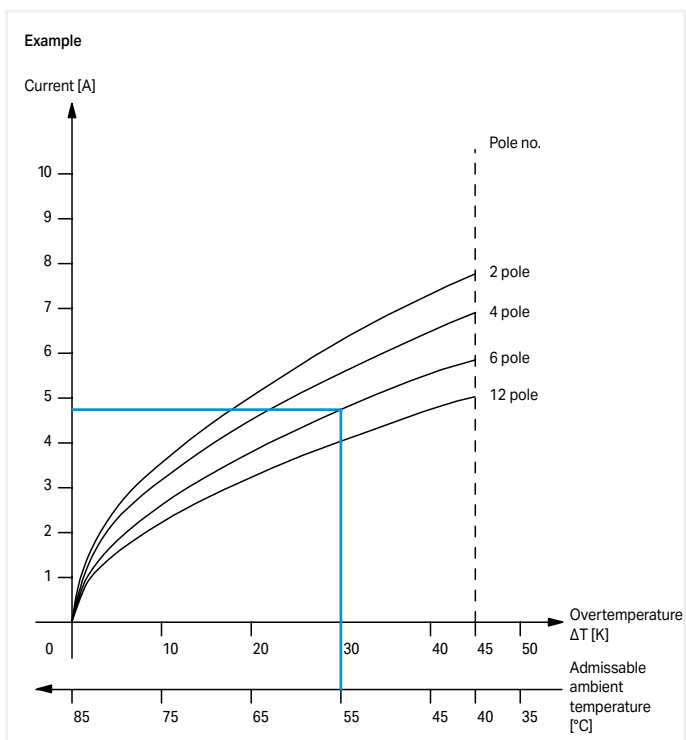

# Tests and Testing Procedures per IEC/EN Standards

## Electrical Tests

• Insulation Parameters per IEC/EN 60664-1 (continued)

**Table F.4 – Creepage Distances to Avoid Failure Due to Tracking**  
DIN EN 60664-1/VEDE 0110-1

Voltage <sup>1</sup> (RMS)	Minimum Creepage Distances								
	Printed Circuits		Pollution Degree						
	Pollution Degree		Pollution Degree						
	1 All Material Groups mm	2 All Material Groups except IIIb mm	1 All Material Groups mm	2 Material group I mm	2 Material group II mm	2 Material group III mm	3 Material group I mm	3 Material group II mm	3 Material group III <sup>2</sup> mm
V									
10	0,025	0,04	0,08	0,4	0,4	0,4	1	1	1
12,5	0,025	0,04	0,09	0,42	0,42	0,42	1,05	1,05	1,05
16	0,025	0,04	0,1	0,45	0,45	0,45	1,1	1,1	1,1
20	0,025	0,04	0,11	0,48	0,48	0,48	1,2	1,2	1,2
25	0,025	0,04	0,125	0,50	0,5	0,5	1,25	1,25	1,25
32	0,025	0,04	0,14	0,53	0,53	0,53	1,3	1,3	1,3
40	0,025	0,04	0,16	0,56	0,8	1,1	1,4	1,6	1,8
50	0,025	0,04	0,18	0,6	0,85	1,2	1,5	1,7	1,9
63	0,04	0,063	0,2	0,63	0,9	1,25	1,6	1,8	2
80	0,063	0,1	0,22	0,67	0,95	1,3	1,7	1,9	2,1
100	0,1	0,16	0,25	0,71	1	1,4	1,8	2	2,2
125	0,16	0,25	0,28	0,75	1,05	1,5	1,9	2,1	2,4
160	0,25	0,4	0,32	0,8	1,1	1,6	2	2,2	2,5
200	0,4	0,63	0,42	1	1,4	2	2,5	2,8	3,2
250	0,56	1	0,56	1,25	1,8	2,5	3,2	3,6	4
320	0,75	1,6	0,75	1,6	2,2	3,2	4	4,5	5
400	1	2	1	2	2,8	4	5	5,6	6,3
500	1,3	2,5	1,3	2,5	3,6	5	6,3	7,1	8
630	1,8	3,2	1,8	3,2	4,5	6,3	8 (7.9) <sup>4</sup>	9 (8.4) <sup>4</sup>	10 (9) <sup>4</sup>
800	2,4	4	2,4	4	5,6	8	10 (9) <sup>4</sup>	11 (9.6) <sup>4</sup>	12,5 (10.2) <sup>4</sup>
1000	3,2	5	3,2	5	7,1	10	12,5 (10.2) <sup>4</sup>	14 (11.2) <sup>4</sup>	16 (12.8) <sup>4</sup>
1250			4,2	6,3	9,	12,5	16 (12.8) <sup>4</sup>	18 (14.4) <sup>4</sup>	20 (16) <sup>4</sup>
1600			5,6	8,	11	16	20 (16) <sup>4</sup>	22 (17.6) <sup>4</sup>	25 (20) <sup>4</sup>
2000			7,5	10	14	20	25 (20) <sup>4</sup>	28 (22.4) <sup>4</sup>	32 (25.6) <sup>4</sup>
2500			10	12,5	18	25	32 (25.6) <sup>4</sup>	36 (28.8) <sup>4</sup>	40 (32) <sup>4</sup>
3200			12,5	16	22	32	40 (32) <sup>4</sup>	45 (36) <sup>4</sup>	50 (40) <sup>4</sup>
4000			16	20,	28	40	50 (40) <sup>4</sup>	56 (44.8) <sup>4</sup>	63 (50.4) <sup>4</sup>
5000			20	25	36	50	63 (50.4) <sup>4</sup>	71 (56.8) <sup>4</sup>	80 (64) <sup>4</sup>
6300			25	32	45	63	80 (64) <sup>4</sup>	90 (72) <sup>4</sup>	100 (80) <sup>4</sup>
8000			32	40	56	80	100 (80) <sup>4</sup>	110 (88) <sup>4</sup>	125 (100) <sup>4</sup>
10000			40	50	71	100	125 (100) <sup>4</sup>	140 (112) <sup>4</sup>	160 (128) <sup>4</sup>
12500			50 <sup>3</sup>	63 <sup>3</sup>	90 <sup>3</sup>	125 <sup>3</sup>			
16000			63 <sup>3</sup>	80 <sup>3</sup>	110 <sup>3</sup>	160 <sup>3</sup>			
20000			80 <sup>3</sup>	100 <sup>3</sup>	140 <sup>3</sup>	200 <sup>3</sup>			
25000			100 <sup>3</sup>	125 <sup>3</sup>	180 <sup>3</sup>	250 <sup>3</sup>			
32000			125 <sup>3</sup>	160 <sup>3</sup>	220 <sup>3</sup>	320 <sup>3</sup>			
40000			160 <sup>3</sup>	200 <sup>3</sup>	280 <sup>3</sup>	400 <sup>3</sup>			
50000			200 <sup>3</sup>	250 <sup>3</sup>	360 <sup>3</sup>	500 <sup>3</sup>			
63000			250 <sup>3</sup>	320 <sup>3</sup>	450 <sup>3</sup>	600 <sup>3</sup>			

<sup>1</sup> This voltage is for:

- Functional insulation; the working voltage
- Basic and supplementary insulation of the circuit energized directly from the mains (see 4.3.2.2.1): for the voltage selected from Table F.3a or F.3b, based on the rated voltage of the equipment, or the rated insulation voltage.
- Basic and supplementary insulation of systems, equipment and internal circuits not energized directly from the mains (see 4.3.2.2.2): the highest rms voltage which can occur in the system, equipment or internal circuit when supplied at rated voltage and under the least favorable combination of operation conditions within the equipment rating.

<sup>2</sup> Material group IIIb is not recommended for applications with pollution degree 3 above 630 V.

<sup>3</sup> Provisional data based on extrapolation. Technical committees who have other information based on experience may use their dimensions.

<sup>4</sup> The values in brackets must only be applied for reducing creepage distances if a rib is used (see 5.2.5).

The high degree of accuracy of the creepage distances given in the table does not imply that the measuring accuracy must be of the same order of magnitude.



# Abbreviations; Material Specifications

## Abbreviations

"e": solid conductor  
 "m": stranded conductor  
 "f": fine-stranded conductor  
 "e+f": solid and fine-stranded conductors  
 "sol.": solid conductor  
 "f-st": fine-stranded conductor

AWG: American Wire Gauge  
 $I_N$  32 A: nominal current of 32 A (e.g., for jumpers)  
 WMB: WAGO Multi marking system  
 WSB: WAGO Quick marking system  
 MTBF: mean time between failures, per IEC 61709, at 25 °C  
 PU: packaging unit (other quantities upon request);  
 if not specified: 1 item

## Material Specifications

### Insulation Materials

WAGO primarily uses polyamide (PA 66 and PA 46) for housing current-conducting parts, as well as polyphthalamide (PPA) and polycarbonate (PC) for insulation material (see table). For more than 50 years, these materials have proven themselves in WAGO products and all are approved by certified third-party agencies. All listed halogen-free and flame-retardant polymer materials do not contain any heavy metals, silicone, asbestos or formaldehyde as formulation components.

### Contact Materials

Hard and extra-hard electrolytic copper (ECu), as well as extra-hard copper alloys, are the standard materials used for the current-carrying parts of all WAGO products. These materials combine excellent conductivity and good chemical resistance without the risk of stress-induced cracking.

### Contact surface

The special tin layer, which is the standard layer for all current-carrying parts in WAGO products, ensures perfect long-term protection against corrosive substances. Furthermore, these layers provide a gas-tight contact that ensures durable contact resistance. At the clamping unit, the conductor is embedded into the soft tin layer with high contact pressure. This protects the contact area against corrosion. The thick tin layer also ensures good solderability of both PCB terminal block and connector solder pins.

### Clamping spring material

Every WAGO clamping spring is made of high-quality, accurately tested austenitic chrome nickel steel (CrNi) with high tensile strength, which boasts proven, long-term corrosion resistance. It is resistant to sea spray, town gas and the industrial emissions sulfur dioxide, and hydrogen sulfide.

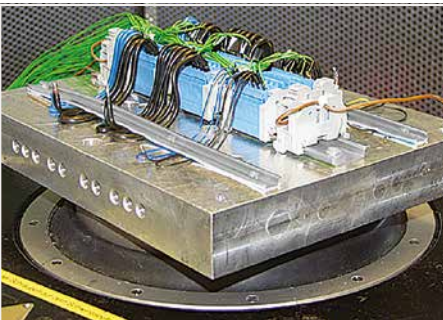

Shock Test per IEC/EN 60068-2-27; IEC/EN 61373 (Railway Applications)

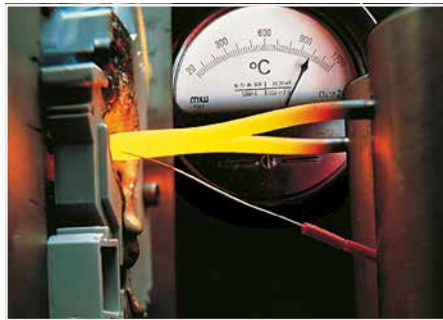

Glow-Wire Test per IEC/EN 60998-1, IEC/EN 60695-2-11

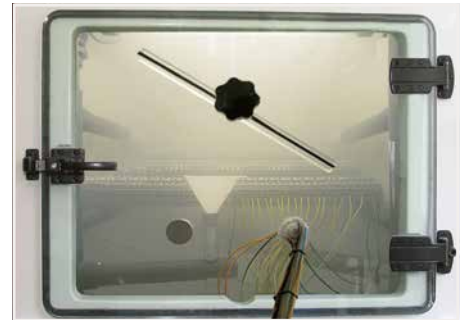

Salt Spray Test per IEC/EN 60068-2-11; DNV GL, LR (Marine Applications)

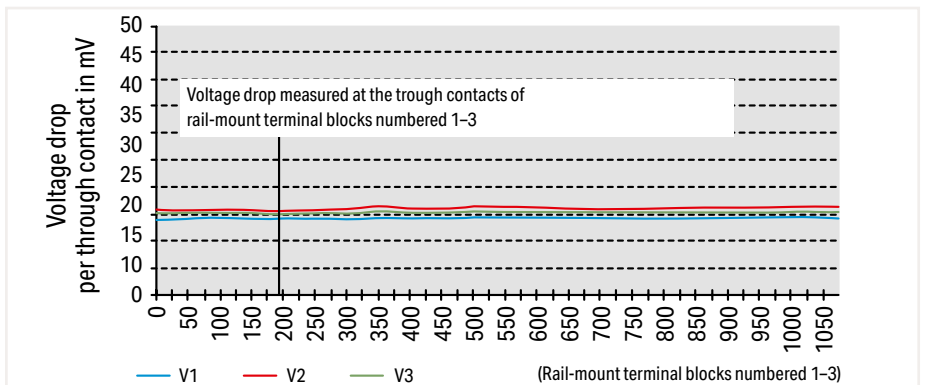
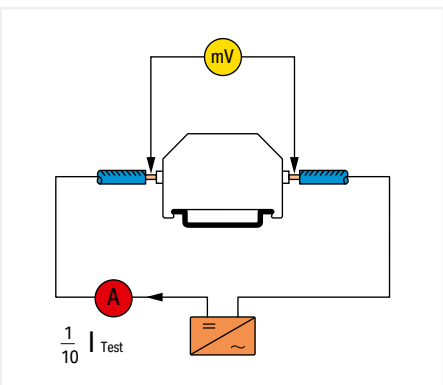

# Item Number Index

Item No.	Page	Item No.	Page	Item No.	Page	Item No.	Page
<b>Serie</b>		<b>210 Series</b>		<b>216 Series</b>		<b>231 Series</b>	
206-118	280	210-801	274	216-322	280	231-125	281
206-294	109			216-413	280		
206-706	281	210-808	274	216-414	280	231-128	281
206-707	281	210-810	274	216-424	280	231-129	142
206-804	281			216-425	280	231-130	142
206-808	281	210-814	274	216-435	280	231-131	143
206-859	152	210-824	274	216-540	280	231-132/001-000	135
206-860	152	210-831	274	216-552	280		
206-861	152			216-573	280	231-154/001-000	135
206-1125	280	210-834	274	216-575	280	231-132/001-000/105-604	135
206-1204	280	210-836	275	216-577	280		
206-1216	280	210-837	275	216-578	280	231-142/001-000/105-604	135
206-1225	280	210-840	275	216-599	280	231-132/040-000	135
206-1250	280						
206-1400	280	210-843	275			231-144/040-000	135
206-1403	280	210-847	275			231-155	281
206-1441	280	210-848	275	<b>218 Series</b>		231-159	143
206-1442	280	210-850	275	218-xxx	146	231-160	142
206-1451	280					231-161	281
206-1481	280	210-855	275	<b>221 Series</b>		231-162/001-000	285
206-1482	280	210-870	273	221-412	111		
				221-412/996-016	124	231-184/001-000	285
		210-877	273	221-413	111	231-162/003-000	135
<b>207 Series</b>		210-880	273	221-413/996-012	124		
207-xxxx	125	210-880/000-002	273	221-415	111	231-180/003-000	135
		210-882	273	221-415/996-008	124	231-193	142
		210-882/000-002	273	221-482	113	231-195	142
				221-483	113	231-202/008-000	138
<b>209 Series</b>				221-485	113		
209-100	278	<b>211 Series</b>		221-500	111	231-216/008-000	138
209-109	278	211-500	274	221-500/000-006	111	231-202/026-000	138
209-120	102			221-500/000-053	111		
209-123	104	211-506	274	221-501	113	231-216/026-000	138
209-129	279	211-811	275	221-502	111	231-202/031-000	138
209-130	279	211-812	275	221-502/000-004	111		
209-137	142	211-813	275	221-503	111	231-216/031-000	138
209-140	277	211-821	275	221-503/000-004	111	231-202/037-000	138
209-141	277	211-823	275	221-505	111		
209-142	277	211-824	275	221-505/000-004	111	231-216/037-000	138
209-145	277	211-829	275	221-510	111	231-231	143
209-148	142	211-835	274	221-510/000-006	111	231-232/001-000	138
209-170	96	211-836	274	221-510/000-053	111		
209-173	141	211-836/000-002	274	221-511	113	231-246/001-000	138
209-174	141	211-837	274	221-612	111	231-232/001-000/105-604	138
209-176	141	211-837/000-002	274	221-612/996-010	124		
209-177	141	211-855	273	221-613	111	231-242/001-000/105-604	138
209-190	20	211-856	273	221-613/996-008	124	231-262/001-000	138
209-191	20	211-857	273	221-615	111		
		211-861	274	221-615/996-006	124	231-276/001-000	138
		211-862	274	221-682	113	231-262/001-000/105-604	138
<b>210 Series</b>		211-863	274	221-683	113		
210-110	211	211-922	275	221-685	113	231-272/001-000/105-604	138
210-111	278			221-941	111	231-291	143
210-115	278	211-927	275	221-941/000-006	111	231-300	281
210-118	278			221-942	111	231-302/008-000	136
210-133	100	<b>215 Series</b>		221-942/000-006	111		
210-136	281	215-xxx	281			231-324/008-000	136
210-137	281			<b>222 Series</b>		231-302/026-000	136
210-141	279	<b>216 Series</b>		222-xxx	111		
210-143	279	216-101	280			231-324/026-000	136
210-154	102			<b>224 Series</b>		231-302/031-000	136
210-196	278	216-110	280	224-101	114		
210-197	278	216-131	280	224-101/996-015	124	231-324/031-000	136
210-198	278	216-132	280	224-104	114	231-302/037-000	136
210-199	143	216-201	280	224-112	114		
210-250	143			224-112/996-015	124	231-324/037-000	136
210-251	143	216-210	280	224-114	114	231-302/107-000	136
210-254	51	216-221	280	224-201	114		
210-297	281	216-222	280			231-316/107-000	136
210-331/250-202	143	216-223	280			231-332/001-000	136
210-331/500-103	143	216-224	280	<b>231 Series</b>			
210-331/508-103	143	216-241	39	231-100	281	231-354/001-000	136
210-331/750-202	143			231-102/008-000	135	231-332/108-000	136
210-331/762-202	143	216-246	39				
210-332/350-202	143	216-262	39	231-124/008-000	135	231-346/108-000	136
210-332/381-202	143	216-263	39	231-102/026-000	135	231-362/001-000	136
210-509	278	216-264	39				
210-522	278	216-266	39	231-124/026-000	135	231-384/001-000	136
210-533	268	216-267	39	231-102/031-000	135	231-393	142
210-647	279	216-284	39			231-426	281
210-648	279	216-286	39	231-124/031-000	135	231-432/001-000	135
210-657	279			231-102/037-000	135		
210-658	279	216-289	39			231-454/001-000	135
210-702	273	216-301	280	231-124/037-000	135	231-432/001-000/105-604	135
210-719	279	216-302	280				
		216-321	280			231-442/001-000/105-604	135
210-722	279						



## Item Number Index

<b>231 Series</b>	
231-432/040-000	135
231-444/040-000	135
231-455	281
231-456	281
231-500	142
231-532/001-000	136
231-554/001-000	136
231-532/108-000	136
231-546/108-000	136
231-562/001-000	136
231-584/001-000	136
231-602	135
231-624	135
231-602/017-000	147
231-612/017-000	147
231-602/018-000	135
231-624/018-000	135
231-602/019-000	135
231-624/019-000	135
231-602/114-000	135
231-624/114-000	135
231-632	136
231-654	136
231-632/018-000	136
231-654/018-000	136
231-632/019-000	136
231-654/019-000	136
231-632/109-000	136
231-646/109-000	136
231-632/114-000	136
231-654/114-000	136
231-632/129-000	136
231-646/129-000	136
231-661	142
231-662	142
231-668	142
231-675	142
231-702/008-000	139
231-712/008-000	139
231-702/026-000	139
231-712/026-000	139
231-702/031-000	139
231-712/031-000	139
231-702/037-000	139
231-712/037-000	139
231-732/001-000	139
231-742/001-000	139
231-762/001-000	139
231-772/001-000	139
231-832/001-000	138
231-846/001-000	138
231-832/001-000/105-604	138
231-842/001-000/105-604	138
231-862/001-000	138
231-876/001-000	138
231-862/001-000/105-604	138
231-872/001-000/105-604	138
231-932/001-000	139
231-942/001-000	139
<b>231 Series</b>	
231-962/001-000	139
231-972/001-000	139
231-2102/026-000	135
231-2116/026-000	135
231-2102/037-000	135
231-2116/037-000	135
231-2202/026-000	138
231-2212/026-000	138
231-2202/037-000	138
231-2212/037-000	138
231-2302/026-000	136
231-2316/026-000	136
231-2302/037-000	136
231-2316/037-000	136
231-2302/107-000	136
231-2316/107-000	136
231-2702/026-000	139
231-2712/026-000	139
<b>232 Series</b>	
232-102/026-000	135
232-124/026-000	135
232-132	135
232-154	135
232-132/005-000	135
232-150/005-000	135
232-132/031-000	135
232-154/031-000	135
232-132/039-000	135
232-154/039-000	135
232-162	136
232-184	136
232-162/031-000	136
232-184/031-000	136
232-162/039-000	136
232-184/039-000	136
232-202/026-000	135
232-224/026-000	135
232-232	135
232-254	135
232-232/031-000	135
232-254/031-000	135
232-232/039-000	135
232-254/039-000	135
232-262	136
232-284	136
232-262/031-000	136
232-284/031-000	136
232-262/039-000	136
232-284/039-000	136
232-302/026-000	136
232-324/026-000	136
232-332	135
232-346	135
232-362	136
232-376	136
232-402/026-000	136
232-424/026-000	136
<b>232 Series</b>	
232-502/007-000	135
232-524/007-000	135
232-532/007-000	136
232-554/007-000	136
232-562/007-000	138
232-572/007-000	138
232-582/007-000	139
232-592/007-000	139
232-602	141
232-610	141
232-612	141
232-632	141
232-640	141
232-642	141
232-646	141
232-662	141
232-665	141
232-667	141
232-670	141
232-682	141
232-685	141
232-687	141
232-732	138
232-746	138
232-732/031-000	138
232-746/031-000	138
232-732/039-000	138
232-746/039-000	138
232-732/047-000	138
232-746/047-000	138
232-762	139
232-772	139
232-762/031-000	139
232-772/031-000	139
232-762/039-000	139
232-772/039-000	139
232-832	138
232-846	138
232-832/031-000	138
232-846/031-000	138
232-832/039-000	138
232-846/039-000	138
232-832/047-000	138
232-846/047-000	138
232-862	139
232-872	139
232-862/039-000	139
232-872/039-000	139
<b>233 Series</b>	
233-1xx	146
233-2xx	146
233-3xx	143
233-4xx	146
233-5xx	146
<b>234 Series</b>	
234-2xx	146
234-5xx	146
<b>235 Series</b>	
235-1xx	146
235-401	148
235-402	147
<b>235 Series</b>	
235-402/331-000	147
235-412/331-000	147
235-448	147
235-5xx	148
235-8xx	149
<b>236 Series</b>	
236-1xx	147
236-2xx	148
236-3xx	149
236-4xx	147
<b>243 Series</b>	
243-112	115
243-113	115
243-144	115
243-204	115
243-208	115
243-211	115
243-212	115
243-304	115
243-308	115
243-504	115
243-508	115
243-742	151
243-748	151
243-804	115
243-808	115
243-9294/996-020	124
<b>247 Series</b>	
247-xxx	276
<b>248 Series</b>	
248-472	276
248-474	276
248-501	208
248-501/000-002	208
248-501/000-005	208
248-501/000-006	208
248-501/000-007	208
248-501/000-012	208
248-501/000-017	208
248-501/000-023	208
248-501/000-024	208
248-502	276
248-506	276
248-566	276
248-578	276
<b>249 Series</b>	
249-101	278
249-116	278
249-117	278
249-118	277
249-119	277
249-120	277
249-125	96
249-126	96
249-127	96
249-130	117
249-197	278
<b>250 Series</b>	
250-102	146
250-124	146
250-202	146
250-224	146
250-202/353-604	146
250-208/353-604	146
250-402	146
250-424	146
250-402/350-604	146
250-408/350-604	146
250-502	147
250-516	147

# Item Number Index

Item No.	Page	Item No.	Page	Item No.	Page	Item No.	Page
<b>250 Series</b>		<b>279 Series</b>		<b>280 Series</b>		<b>280 Series</b>	
250-602	148	279-490	96	280-520	78	280-996	74
		279-492	96	280-523	78	280-998	74
250-612	148	279-501	78	280-524	78	<b>281 Series</b>	
250-702	147	279-504	78	280-527	78	281-101	80
		279-507	78	280-529	78	281-104	80
250-724	147	279-508	78	280-530	78	281-107	80
250-1402	146	279-509	78	280-533	78	281-301	80
		279-512	78	280-534	78	281-302	80
250-1424	146	279-513	78	280-537	78	281-309	86
<b>252 Series</b>		279-517	78	280-547	79	281-311	86
252-xxx	151	279-518	78	280-548	79	281-312	75
<b>253 Series</b>		279-519	78	280-549	79	281-313	75
253-xxx	147	279-527	78	280-550	79	281-313	75
<b>254 Series</b>		279-681	73	280-551	79	281-324	75
254-4xx	147			280-552	79	281-326	75
254-5xx	148	279-687	73	280-554	89	281-328	75
254-6xx	149	279-687/999-950	73	280-555	89	281-329	75
<b>255 Series</b>		279-826	73	280-556	89	281-334	75
255-4xx	147	279-831	73	280-557	79	281-335	75
255-5xx	148			280-558	79	281-340	78
255-6xx	149	279-838	73	280-560	88		
<b>Serie 256</b>		279-901	73	280-560/281-434	88	281-345	75
256-4xx	147			280-562	89	281-349	75
256-5xx	148	279-907	73	280-562/281-411	89	281-355	75
256-6xx	149	279-907/999-950	73	280-562/281-420	89	281-357	75
<b>257 Series</b>		279-992	73	280-562/281-434	89	281-365	79
257-4xx	147			280-564	88	281-366	79
257-5xx	148	279-995	73	280-564/281-483	88	281-402	96
257-6xx	149	<b>280 Series</b>		280-570	88	281-407	96
<b>258 Series</b>		280-101	80	280-570/281-434	88	281-409	96
258-xxxx	272	280-104	80	280-572	89	281-415	96
<b>260 Series</b>		280-107	80	280-572/281-411	89	281-418	96
260-xxx	105	280-107	80	280-572/281-420	89	281-419	96
<b>261 Series</b>		280-301	80	280-572/281-434	89	281-421	96
261-xxx	105	280-302	80	280-574	88	281-422	96
<b>262 Series</b>		280-306	79	280-574/281-483	88	281-440	279
262-xxx	105	280-308	74	280-580	88	281-470	96
<b>264 Series</b>		280-309	74	280-580/281-434	88	281-471	96
264-xxx	103	280-312	74	280-584	88	281-472	96
264-900	276			280-584/281-483	88	281-482	96
<b>279 Series</b>		280-315	74	280-585	89	281-483	96
279-101	80	280-319	88	280-586	89	281-485	96
279-104	80	280-320	88	280-592	89	281-490	96
279-284	278	280-321	88	280-593	89	281-492	96
279-308	73	280-323	88	280-597	79	281-511	87
279-325	73	280-324	74	280-631	74	281-512	87
279-328	73	280-326	74	280-637	74	281-512/281-417	87
279-330	73	280-340	78	280-637/999-950	74	281-512/281-418	87
279-339	73	280-341	78	280-640	74	281-512/281-501	87
279-341	73	280-342	78	280-646	74	281-530	79
279-344	73	280-343	78	280-650	74	281-531	79
279-346	73	280-352	74	280-651	74	281-532	79
279-348	73	280-354	74	280-653	74	281-611	86
279-402	96	280-356	74	280-654	74	281-611/281-417	86
279-409	96	280-358	74	280-656	74	281-611/281-418	86
279-415	96	280-371	82	280-671	74	281-611/281-541	86
279-422	96	280-373	82	280-672	74	281-611/281-542	86
279-432	279	280-374	82	280-681	74	281-612	86
279-433	279	280-376	82	280-684	74	281-612/281-417	86
279-440	279	280-402	88	280-687	74	281-612/281-418	86
279-470	96	280-404	96	280-687/999-950	74	281-612/281-541	86
279-471	96	280-409	96	280-830	74	281-612/281-542	86
279-482	96	280-415	96			281-613	86
279-483	96	280-418	96	280-835	74	281-613/281-417	86
<b>279 Series</b>		280-419	96	280-837	74	281-613/281-418	86
279-101	80	280-422	96	280-837/999-950	74	281-613/281-541	86
279-104	80	280-432	279	280-838	74	281-613/281-542	86
279-284	278	280-433	279	280-868	82	281-616	86
279-308	73	280-440	279			281-619	78
279-325	73	280-470	88	280-871	82	281-620	78
279-328	73	280-471	88	280-874	82	281-622	86
279-330	73	280-472	88	280-875	82	281-622/281-417	86
279-339	73	280-482	96	280-876	82	281-622/281-418	86
279-341	73	280-483	96	280-879	82	281-622/281-541	86
279-344	73	280-490	96			281-622/281-542	86
279-346	73	280-492	96	280-885	82	281-623	86
279-348	73	280-502/281-582	255	280-901	74	281-623/281-417	86
279-402	96					281-623/281-418	86
279-409	96	280-502/281-595	255	280-907	74	281-623/281-541	86
279-415	96	280-502/281-602	255	280-907/999-950	74	281-623/281-541	86
279-422	96			280-944/281-589	255	281-624	86
279-432	279	280-502/281-614	255			281-629	78
279-433	279	280-503/281-579	255	280-944/281-595	255	281-630	78
279-440	279			280-946	74	281-631	75
279-470	96	280-504/281-588	255	280-992	74	281-637	75
279-471	96	280-517	78	280-993	74	281-637/999-950	75
279-482	96	280-519	78	280-994	74		
279-483	96						

## Item Number Index

Item No.	Page	Item No.	Page	Item No.	Page	Item No.	Page
<b>281 Series</b>		<b>282 Series</b>		<b>284 Series</b>		<b>285 Series</b>	
281-651	75	282-436/304-000	51	284-339	76	285-1175	31
		282-437/011-000	51	284-341	76		
281-654	75	282-437/012-000	51	284-400	96	285-1179	31
281-656	87	282-438/300-000	51	284-402	96	285-1181	30
281-657	75	282-438/301-000	51	284-409	96	285-1184	30
281-657/999-950	75	282-439/011-000	51	284-413	77	285-1185	30
281-658	75	282-440	37	284-414	77	285-1187	30
281-663	75	282-638	82	284-415	96	285-1187/999-950	30
281-664	75			284-422	96	285-1189	30
281-668	75	282-641	82	284-681	76	<b>288 Series</b>	
281-672	86	282-681	76	284-682	76	288-304	250
281-678	75	282-682	76	284-684	76	288-312	250
281-679	75	282-684	76	284-687	76	288-364	250
281-681	75	282-687	76	284-687/999-950	76	288-368	250
281-684	75	282-687/999-950	76	284-901	76	288-380	250
		282-694	82	284-902	76	288-413	250
281-687	75	282-695	82	284-904	76	288-414	250
281-687/999-950	75	282-696	86	284-907	76	288-418	250
281-901	75	282-697	82	284-907/999-950	76	288-437	250
		282-698/281-413	86	284-992	76	288-504	250
281-907	75	282-698/281-429	86	284-993	76	288-512	250
281-907/999-950	75	282-698/281-434	86	<b>285 Series</b>		288-564	250
281-916	87	282-698/281-449	86	285-131	30	288-600	268
281-992	75	282-699	82			288-601	268
281-993	75	282-811	83	285-137	30	288-602	268
281-994	75	282-821	83	285-137/999-950	30	288-620	268
281-998	75	282-841	83	285-139	31	288-621	268
		282-841/049-000	83	285-141	30	288-622	268
<b>282 Series</b>		282-860	83	285-143	30	288-626	268
282-101	80	282-865	83	285-144	30	288-627	268
282-104	80	282-866	83	285-147	30	288-837	267
282-107	80	282-868	83	285-147/999-950	30	288-863	186
282-120	81	282-870	83	285-148	31	288-895	225
282-122	81	282-881	51	285-150	30	<b>289 Series</b>	
282-124	81	282-882	51	285-151	30	289-172	267
282-126	81	282-888	51	285-154	30	289-174	267
282-128	81	282-901	76	285-157	30		
282-128/281-413	81	282-902	76	285-157/999-950	30	289-179	267
282-128/281-417	81	282-904	76	285-159	31	289-195	267
282-128/281-418	81	282-907	76	285-168	31	289-197	267
282-131	81	282-907/999-950	76	285-169	31	289-198	267
282-133	81	282-992	76	285-170	31	289-501	266
282-135	81	282-993	76	285-172	279		
282-137	81	<b>283 Series</b>		285-173	279	289-509	266
		283-101	80	285-175	31	289-540	266
282-141	81	283-104	80	285-181	30		
282-301	80	283-107	80	285-184	30	289-559	266
282-302	80	283-301	80	285-187	30	289-611	266
282-308	76	283-302	80	285-188	31		
282-311	81	283-325	77	285-191	30	289-619	266
282-312	81	283-328	77	285-194	30	289-707	266
282-314	81	283-330	77	285-195	30	289-708	266
282-315	81	283-350	77	285-197	30	289-710	266
282-325	76	283-352	77	285-197/999-950	30	289-713	266
282-328	76	283-354	77	285-199	31	289-714	266
282-330	76	283-400	96	285-207	31	289-720	266
282-333	82	283-402	96	285-221	31	289-721	266
282-334	82	283-409	96	285-227	31	289-725	266
282-339	76	283-414	77	285-235	31	289-726	266
282-341	76	283-415	96	285-240	31	<b>294 Series</b>	
282-360	83	283-422	96	285-241	31	294-199	109
282-361	83	283-671	77	285-242	277	294-364	109
282-365	83	283-672	77	285-244	31	294-370	109
282-366	83	283-674	77			294-375	109
282-369	278	283-677	77	285-450	31	294-384	109
282-385	83	283-677/999-950	77	285-495	31	294-4xxx	109
282-386	83	283-901	77	285-634	77	294-5xxx	108
282-387	83	283-902	77	285-635	77	<b>704 Series</b>	
282-390	83	283-904	77	285-637	77	704-xxxx	265
282-391	83	283-907	77	285-637/999-950	77	<b>706 Series</b>	
282-392	83	283-907/999-950	77	285-935	30	706-100/1602-200	235
282-402	96	283-992	77	285-950	30	706-23xx	265
282-409	96	283-998	77	285-992	77	706-77xx	208
282-422	96	<b>284 Series</b>		285-995	30		
282-424	83	284-101	80	285-1161	30		
282-432	37	284-104	80	285-1163	30		
		284-107	80	285-1164	30		
282-435	37	284-107	80	285-1165	31		
282-432/100-000	51	284-301	80	285-1167	30		
282-433/011-000	51	284-302	80	285-1167/999-950	30		
282-433/100-000	51	284-308	76	285-1169	31		
282-434/100-000	51	284-325	76	285-1171	31		
282-435/011-000	51	284-328	76				
282-435/300-000	51	284-330	76				
282-435/301-000	51						
282-436/301-000	51						

# Item Number Index

Item No.	Page	Item No.	Page	Item No.	Page	Item No.	Page
<b>709 Series</b>		<b>731 Series</b>		<b>734 Series</b>		<b>734 Series</b>	
709-153	278	731-602/019-000	138	734-232/105-604	133	734-638	141
709-154	278						
709-156	278	731-616/019-000	138	734-242/105-604	133	734-642	141
709-167	278	731-602/114-000	138	734-262	133	734-671	142
709-168	278					<b>735 Series</b>	
709-169	278	731-616/114-000	138	734-280	133	735-1xx	146
709-177	273	731-632	139	734-262/105-604	133	735-3xx	147
709-178	273					735-500	281
709-183	278	731-642	139	734-272/105-604	133	<b>736 Series</b>	
709-196	268	731-632/018-000	139	734-302	132	736-1xx	147
709-310	96					736-3xx	148
709-311	96	731-642/018-000	139	734-324	132	736-5xx	148
709-581	278	731-632/019-000	139	734-302/018-000	132	736-6xx	149
709-582	278					736-7xx	149
709-583	278	731-642/019-000	139	734-324/018-000	132	736-8xx	150
709-591	278	731-632/114-000	139	734-302/019-000	132	<b>737 Series</b>	
<b>713 Series</b>		731-646/114-000	139	734-324/019-000	132	737-1xx	147
713-xxx	131			734-326	66	737-3xx	148
<b>714 Series</b>		<b>732 Series</b>				737-5xx	148
714-xxx	131	732-122/026-000	139	734-329	66	737-6xx	149
<b>721 Series</b>		732-132/026-000	139	734-332	133	737-7xx	149
721-1xx	134					737-8xx	150
721-2xx	137	<b>733 Series</b>		734-350	133	<b>738 Series</b>	
721-302/008-000	134	733-1xx	131	734-332/018-000	133	738-1xx	147
		733-1xx/037-000	131			738-3xx	148
721-320/008-000	134	733-130	143	734-350/018-000	133	<b>739 Series</b>	
721-302/031-000	134	733-191	143	734-332/019-000	133	739-102	147
		733-2xx	131				
721-320/031-000	134	733-3xx	131	734-350/019-000	133	739-124	147
721-332/031-000	137	733-3xx/105-604	131	734-362	132	739-152	148
		<b>734 Series</b>					
721-342/031-000	137	734-102	132	734-372	132	739-174	148
721-332/008-000	137			734-362/008-000	132	739-202	148
		734-124	132				
721-342/008-000	137	734-102/008-000	132	734-372/008-000	132	739-212	148
721-4xx	134			734-362/037-000	132	739-232	149
721-6xx	134	734-124/008-000	132				
721-8xx	137	734-102/037-000	132	734-372/037-000	132	739-242	149
721-21xx	134			734-400	142	739-302	146
721-22xx	137	734-102/107-000	132	734-402	132		
<b>722 Series</b>		734-124/107-000	132			739-312	146
722-1xx	134	734-126	141	734-412	132	739-332	146
722-2xx	134			734-402/001-000	132		
722-7xx	137	734-130	142			739-342	146
722-8xx	137	734-132	132	734-412/001-000	132	739-3202	149
<b>723 Series</b>						739-3212	149
723-xxx	137	734-154	132	734-426	141	<b>740 Series</b>	
<b>726 Series</b>		734-132/105-604	132			740-xxx	147
726-xxx	98	734-146/105-604	132	734-431	141	<b>741 Series</b>	
<b>727 Series</b>		734-132/108-000	132	734-432	133	741-1xx	147
727-xxx	99			734-442	133	741-2xx	148
<b>731 Series</b>		734-154/108-000	132	734-432/001-000	133	741-3xx	148
731-132	147	734-146/105-604	132			741-4xx	149
731-142/048-000	147	734-132/108-000	132	734-442/001-000	133	741-5xx	149
731-502/008-000	135			734-462	132	741-6xx	150
		734-159	142			<b>742 Series</b>	
731-520/008-000	135	734-162	132	734-484	132	742-101	147
731-502/031-000	135			734-462/037-000	132	742-106	148
		734-184	132			742-111	147
731-520/031-000	135	734-162/105-604	132	734-484/037-000	132	742-116	148
731-532/008-000	138			734-502	133	742-121	147
		734-176/105-604	132			742-126	148
731-546/008-000	138	734-162/108-000	132	734-520	133	742-153	147
731-532/031-000	138			734-502/037-000	133	742-158	148
		734-184/108-000	132			742-163	147
731-546/031-000	138	734-190	143	734-554	132	742-168	148
731-602	138	734-191	143	734-532/037-000	132	742-176	148
		734-202	133			742-178	147
731-616	138			734-520/037-000	133	<b>744 Series</b>	
731-602/018-000	138	734-220	133			744-xxx	146
		734-202/008-000	133	734-580	133	<b>745 Series</b>	
731-616/018-000	138			734-562	133	745-1xx	146
		734-220/008-000	133			745-2xx	147
		734-202/037-000	133	734-580/037-000	133	745-3xx	147
						745-4xx	148
		734-220/037-000	133	734-602	141	745-5xx	148
		734-226	141			745-6xx	149
				734-612	141	745-7xx	149
		734-229	141	734-632	141	745-8xx	150
		734-230	143			745-9xx	150
		734-231	143	734-636	141	746-1xx	150
		734-232	133			746-2xx	150
						746-3xx	150
		734-250	133			746-4xx	150

# Item Number Index

Item No.	Page	Item No.	Page	Item No.	Page	Item No.	Page
<b>745 Series</b>		<b>750 Series</b>		<b>750 Series</b>		<b>750 Series</b>	
745-102	147	750-332	189	750-461	195	750-531/000-800	193
		750-333	189	750-461/000-200	195	750-532	193
745-112	147	750-333/025-000	189	750-461/003-000	195	750-534	193
745-152	148	750-333/040-000	205	750-461/020-000	195	750-535	203
		750-337	189	750-461/025-000	195	750-535/040-000	205
745-162	148	750-337/025-000	189	750-463	195	750-536	193
745-181	151	750-338	189	750-464	195	750-537	193
		750-338/040-000	205	750-464/020-000	195	750-537/040-000	205
745-185	151	750-342	189	750-464/040-000	205	750-538	203
745-191	151	750-343	189	750-465	195	750-539	203
		750-344	189			750-550	197
745-195	151	750-346	189	750-468	195	750-550/000-200	197
745-202	149	750-347	189	750-468/025-000	195	750-552	197
		750-348	189	750-468/040-000	205		
745-212	149	750-352/040-000	205	750-469	195	750-557	197
745-281	151	750-354	189	750-469/000-006	195	750-557/040-000	205
		750-354/000-001	189	750-469/000-200	195	750-559	197
745-285	151	750-354/000-002	189	750-469/003-000	195	750-559/025-000	197
745-302	148	750-362	189	750-469/040-000	205	750-559/040-000	205
		750-362/040-000	205	750-470	195	750-560	197
745-312	148	750-363	189			750-562	197
745-352	149	750-363/040-000	189	750-480	195	750-563	197
		750-364/040-000	205	750-481/003-000	203	750-563/040-000	205
745-362	149	750-365/040-000	205	750-481/040-000	205	750-564	197
745-381	151	750-366	189	750-482	195	750-585	203
		750-375	189	750-482/000-001	195	750-585/040-000	205
745-385	151	750-375/025-000	189	750-482/000-300	195	750-586	203
745-391	151	750-377	189	750-482/025-000	195	750-597	197
		750-377/025-000	189	750-483	195	750-600	201
745-395	151	750-400	191	750-483/040-000	205	750-600/025-000	201
745-502/006-000	149			750-484	203	750-600/040-000	205
		750-403	191	750-484/000-001	203	750-601	201
745-505/006-000	149	750-404	199	750-484/040-000	205	750-601/040-000	205
745-582	151	750-404/000-001	199	750-485	203	750-602	201
		750-404/000-003	199	750-486	203	750-602/025-000	201
745-585	151	750-404/000-004	199	750-486/040-000	205	750-602/040-000	205
745-602/006-000	150	750-404/000-005	199	750-487/003-000	203	750-603	201
		750-404/040-003	205	750-489	203	750-604	201
745-605/006-000	150	750-405	191	750-491	195	750-606	202
745-631	151	750-406	191	750-491/000-001	195	750-606/040-000	205
		750-407	191	750-492	195	750-609	201
745-635	151	750-407/040-000	205	750-492/040-001	205	750-610	201
745-652/006-000	151	750-408	191	750-493	195	750-610/040-000	205
				750-493/000-001	195	750-611	201
745-655/006-000	151	750-412	191	750-493/025-000	195	750-612	201
745-681	151	750-414	191	750-494	195	750-612/040-000	205
		750-415	191	750-494/000-001	195	750-613	201
745-685	151	750-418	191	750-494/000-005	195	750-613/040-000	205
745-1352	149	750-421	191	750-494/025-000	195	750-614	201
				750-494/025-001	195	750-614/040-000	205
745-1362	149	750-425	191	750-495	195	750-615	201
745-1402	150	750-427	191	750-495/000-001	195	750-616	201
		750-427/040-000	205	750-495/000-002	195	750-616/030-000	201
745-1412	150	750-428	191	750-495/040-000	205	750-616/040-000	205
745-1452	150	750-429/040-001	205	750-495/040-001	205	750-617	201
		750-430	191	750-495/040-002	205	750-621	201
745-1462	150	750-430/025-000	191	750-496	195	750-622	201
745-3102	147	750-430/040-000	205	750-497	195	750-623	201
		750-431	191	750-498	195	750-624	201
745-3112	147	750-431/040-000	205	750-501	193	750-624/000-001	201
745-3152	148	750-432	191	750-501/000-800	193	750-624/020-000	201
		750-433	191	750-502	193	750-624/020-001	201
745-3162	148	750-435	203	750-502/000-800	193	750-624/020-002	201
745-3202	149	750-436	191	750-504	193	750-624/040-000	205
		750-437	191	750-504/000-800	193	750-624/040-001	205
745-3212	149	750-438	203	750-504/025-000	193	750-625/000-001	202
745-3252	150	750-439	203	750-504/025-800	193	750-626	201
		750-439/040-000	205	750-506	193	750-626/020-000	201
745-3262	150	750-450	195	750-506/000-800	193	750-626/020-002	201
				750-508	193	750-626/025-000	201
<b>746 Series</b>		750-453	195	750-508/000-800	193	750-626/025-001	201
746-xxxx	148	750-453/040-000	205	750-508/040-000	205	750-626/040-000	205
		750-454	195	750-509	193	750-627	201
<b>750 Series</b>		750-454/000-003	195	750-511	199	750-628	201
750-100	208	750-454/000-200	195	750-511/000-001	199	750-630	199
750-103	277	750-454/025-000	195	750-511/000-002	199	750-630/003-000	199
750-106	277	750-454/025-003	195	750-512	193	750-630/040-001	205
750-107	277	750-455	195			750-632	199
750-304	189	750-455/020-000	195	750-517	193	750-632/000-100	199
750-306	189	750-455/025-000	195	750-517/040-000	205	750-633	203
750-307	189	750-455/040-000	205	750-519	193	750-633/040-000	205
750-310	189	750-456	195	750-523	193	750-635	199
750-315/300-000	189	750-456/000-200	195	750-527	193	750-636	199
750-316/300-000	189	750-457	195	750-528	193	750-636/000-700	199
750-325	189	750-457/025-000	195	750-530	193	750-636/000-800	199
		750-457/040-000	205	750-530/025-000	193	750-636/025-000	199
		750-459	195	750-531	193	750-637	199

# Item Number Index

Item No.	Page	Item No.	Page	Item No.	Page	Item No.	Page
<b>750 Series</b>		<b>750 Series</b>		<b>753 Series</b>		<b>756 Series</b>	
750-637/000-001	199	750-1407	191	753-467	195	756-3505/050-003	207
750-637/000-002	199	750-1415	191	753-469	195		
750-637/000-003	199	750-1415/040-000	205	753-469/003-000	195	756-3505/050-150	207
750-637/000-004	199	750-1416	191	753-472	195	756-3506/050-003	207
750-637/040-001	205	750-1416/040-000	205	753-474	195		
750-638	199	750-1417	191			756-3506/050-150	207
750-638/025-000	199	750-1418	191	753-480	195	756-8101	211
750-642	199	750-1420	191	753-482	195	756-8102	211
750-643	199	750-1421	191	753-483	195		
750-645	199	750-1422	191	753-492	195	<b>757 Series</b>	
750-652	199	750-1423	191	753-501	193	757-xxx	211
750-652/025-000	199	750-1425	191	753-501/000-800	193	757-901/000-050	273
750-662/040-000	205	750-1491	195	753-502	193		
750-655	199	750-1500	193	753-502/000-800	193	<b>758 Series</b>	
750-657	199	750-1501	193	753-504	193	758-879/000-000	209
750-658	199	750-1502	191	753-506	193	758-879/000-001	209
750-658/040-000	205	750-1504	193	753-508	193	758-879/000-2108	209
750-660/000-001	202	750-1505	193	753-509	193	758-879/000-3102	209
750-661/000-003	202	750-1506	191	753-511	199	758-879/000-3102	186
750-662/000-003	202	750-1515	193	753-512	193	758-879/000-3108	209
750-663/000-003	202	750-1515/040-000	205	753-513	193	758-910	209
750-665/000-001	202	750-1516	193	753-513/000-001	193	758-912	209
750-666/000-003	202	750-1602	186	753-514	193	758-918	209
750-667/000-003	202	750-1605	201	753-516	193	758-918/000-001	209
750-668/000-004	202	750-1605/040-000	205	753-517	193	758-919	209
750-669/000-003	202	750-1606	201	753-530	193	758-940/001-000	175
750-670	199	750-1606/040-000	205	753-531	193	758-940/003-000	175
750-671	199	750-1607	201	753-531/000-800	193	758-975	209
750-672	199	750-8100	186	753-534	193		
750-673	199	750-8101	186	753-536	193	<b>759 Series</b>	
750-806	187	750-8101/000-010	186	753-537	193	759-302	171
750-815/300-000	187	750-8101/025-000	186	753-540	193	759-302/000-923	171
750-815/325-000	187	750-8102	186	753-550	197	759-333	170
750-816/300-000	187	750-8102/025-000	186	753-552	197	759-333/000-923	170
750-821	177	750-8202/000-011	186			759-850	221
750-823	187	750-8202/000-012	186	753-557	197	759-851	221
750-829	187	750-8202/000-022	186	753-559	197	759-920	171
750-832	187	750-8202/040-000	186	753-602	201		
750-832/000-002	187	750-8202/040-001	186	753-603	201	<b>762 Series</b>	
750-833	187	750-8206/040-000	186	753-604	201	762-xxxx	179
750-833/025-000	187	750-8206/040-001	186	753-612	201		
750-837	187	750-8207/000-022	186	753-614	201		
750-837/021-000	187	750-8207/025-000	186	753-620	201	<b>763 Series</b>	
750-838	187	750-8207/025-001	186	753-629/020-000	201	763-xxxx	185
750-838/021-000	187	750-8207	186	753-635	199		
750-838/040-000	187	750-8208	186	753-638	199		
750-842	187	750-8208/025-000	186	753-646	199		
750-843	187	750-8208/025-001	186			<b>765 Series</b>	
750-862	187	750-8210	186	753-649	199	765-xxxx	207
750-882	187			753-652	199		
750-885	187	750-8217	186	753-655	199		
750-885/025-000	187	750-8217/025-000	186	753-661/000-003	202	<b>768 Series</b>	
750-889	187			753-662/000-003	202	768-xxxx	185
750-890	187	<b>753 Series</b>		753-666/000-003	202		
750-890/025-000	187	753-110	208	753-667/000-003	202	<b>769 Series</b>	
750-890/025-001	187	753-120	208	753-668/000-004	202	769-101	95
750-890/025-002	187	753-150	208	753-1629	201	769-101/022-000	95
750-890/040-000	187	753-400	191	753-1629/000-001	201	769-102	95
750-890/040-001	187			753-1630	199	769-102/022-000	95
750-891	187	753-403	191	753-1631	199	769-103	95
750-893	187	753-404	199	<b>756 Series</b>		769-103/022-000	95
750-923	186	753-404/000-003	199	756-1201/060-020	207	769-115	95
750-923/000-001	209	753-404/000-005	199			769-115/022-000	95
750-960	209	753-405	191	756-1201/060-200	207	769-121	95
750-961	209	753-406	191	756-1202/060-020	207	769-122	95
750-962	209	753-408	191			769-123	95
750-963	209			756-1202/060-200	207	769-135	95
750-965	209	753-412	191	756-1203/060-020	207	769-151	91
750-971	209	753-415	191			769-156	91
750-972	209	753-418	191	756-1203/060-200	207	769-171	91
750-975	208	753-421	191	756-1204/060-020	207	769-171/000-006	91
750-976	208					769-176	91
750-977/000-011	208	753-425	191	756-1204/060-200	207	769-176/000-006	91
750-977/000-012	208	753-427	191	756-3501/050-020	207	769-176/000-012	91
750-977/000-013	208					769-201	91
750-978/000-011	208	753-434	191	756-3501/050-150	207	769-202	92
750-978/000-012	208	753-436	191	756-3502/050-020	207	769-203	92
750-978/000-013	208	753-437	191			769-207	91
750-979/000-011	208	753-440	191	756-3502/050-150	207	769-208/281-410	93
750-979/000-012	208	753-452	195	756-3503/050-020	207	769-208/281-411	93
750-979/000-013	208					769-209/281-413	93
750-1400	191	753-457	195	756-3503/050-150	207	769-209/281-434	93
750-1400	264	753-459	195	756-3504/050-020	207	769-211	91
750-1402	191	753-461	195			769-212	92
750-1405	191	753-461/003-000	195	756-3504/050-150	207	769-213	92
750-1405/040-000	205	753-465	195			769-214	91
750-1406	191	753-466	195				



## Item Number Index

Item No.	Page	Item No.	Page	Item No.	Page	Item No.	Page
<b>769 Series</b>		<b>787 Series</b>		<b>787 Series</b>		<b>788 Series</b>	
769-217	91	787-101	225	787-1662/006-1000	226	788-346	243
769-218/281-410	93	787-712	223	787-1662/106-000	226	788-353	243
769-218/281-411	93	787-722	223	787-1664	226	788-354	243
769-219/281-413	93	787-732	223	787-1664/000-004	226	788-356	243
769-219/281-434	93	787-734	223	787-1664/000-011	226	788-357	243
769-221	91	787-736	223	787-1664/000-054	226	788-384	243
769-222	92	787-738	223	787-1664/000-080	226	788-390	243
769-223	92	787-740	223	787-1664/000-100	226	788-404	243
769-227	91	787-783	227	787-1664/000-200	226	788-412	243
769-228/281-410	93	787-783/000-040	227	787-1664/000-250	226	788-506	243
769-228/281-411	93	787-785	227	787-1664/004-1000	226	788-507	243
769-229/281-413	93	787-785/000-040	227	787-1664/006-1000	226	788-508	243
769-229/281-434	93	787-818	221	787-1664/006-1054	226	788-512	243
769-231	91	787-819	221	787-1664/106-000	226	788-515	243
769-232	92	787-821	221	787-1664/106-011	226	788-516	243
769-233	92	787-822	221	787-1664/212-1000	226	788-541	243
769-237	91	787-831	221	787-1668	226	788-543	243
769-238/281-410	93			787-1668/000-004	226	788-544	243
769-238/281-411	93	787-835	221	787-1668/000-054	226	788-546	243
769-239/281-413	93	787-840	221	787-1668/000-080	226	788-548	243
769-239/281-434	93	787-842	221	787-1668/000-200	226	788-549	243
769-251	91	787-844	221	787-1668/000-250	226	788-607	243
769-251/000-006	91	787-845	221	787-1668/006-1000	226	788-608	243
769-257	91	787-847	221	787-1668/006-1054	226	788-615	243
769-301	91	787-850	221	787-1668/106-000	226	788-616	243
		787-852	221	787-1668/106-054	226	788-700	244
769-308	91	787-854	221	787-1671	227	788-701	244
769-309	92	787-870	227	787-1675	227	788-710	244
		787-871	227	787-1685	227	788-720	244
769-312	92	787-872	227	787-1701	223	788-721	244
769-315	91	787-873	227	787-1702	223	788-730	244
769-316	91	787-875	227	787-1711	223	788-906	243
769-320	91	787-876	227	787-1712	223		
769-321	91	787-878/000-2500	227	787-1721	223	<b>789 Series</b>	
769-410	95	787-878/001-3000	227	787-1722	223	789-304	249
		787-880	227	787-1732	223	789-312	249
769-414	95	787-881	227	787-2742	223	789-323	249
769-428	95	787-885	227	787-2744	223		
		787-886	227	787-2801	225	789-326	249
769-431	95	787-890	221	787-2802	225	789-329	249
769-435	95	787-915	227	787-2803	225	789-508	249
769-470	95	787-916	227	787-2805	225	789-520	249
769-471	95	787-1001	224	787-2810	225	789-536	249
769-472	95	787-1002	224	787-2850	224	789-552	249
769-1602	95	787-1007	175	787-2852	234	789-665	253
769-1605	95	787-1011	224	787-2861/050-000	226	789-1341	249
769-1606	95	787-1012	224	787-2861/100-000	226	789-1346	249
769-1615	95	787-1014	225	787-2861/108-020	226	789-1544	249
		787-1014/072-000	225	787-2861/200-000	226	789-1549	249
		787-1015/072-000	225	787-2861/400-000	226		
<b>770 Series</b>		787-1017	224	787-2861/600-000	226	<b>790 Series</b>	
770-xxx	161	787-1020	224	787-2861/800-000	226	790-xxx	217
		787-1021	224				
		787-1022	224	<b>788 Series</b>			
<b>773 Series</b>		787-1102	224	788-100	244		
773-102	121	787-1112	224			<b>792 Series</b>	
773-102/996-020	124	787-1122	224	788-103	244	792-xxx	254
773-104	121	787-1200	224	788-113	244		
773-104/996-010	124	787-1201	224	788-117	243		
773-106	121	787-1202	224	788-118	243	<b>793 Series</b>	
773-106/996-010	124	787-1211	224	788-120	244	793-472	276
773-108	121	787-1212	224			793-502	276
773-108/996-010	124	787-1216	224	788-125	244		
773-173	121	787-1221	224	788-148	244	793-508	276
773-173/996-005	124	787-1226	224	788-150	244	793-544	276
773-331	121	787-1601	222	788-152	244	793-545	276
773-332	121	787-1602	222	788-154	244	793-565	276
773-332/996-004	124	787-1606	222	788-156	244	793-566	276
773-492	121	787-1611	222	788-158	244	793-599	276
773-493	121	787-1616	222	788-160	244	793-602	276
773-494	121	787-1616/000-1000	222	788-162	244		
773-496	121	787-1621	222	788-164	244	793-608	276
773-498	121	787-1622	222	788-166	244	793-644	276
773-504	121	787-1623	222	788-168	244	793-645	276
773-602	121	787-1628	222	788-170	244	793-666	276
773-604	121	787-1631	222	788-172	244	793-699	276
773-606	121			788-174	244	793-900	276
		787-1635	222	788-176	244	793-3501	276
<b>780 Series</b>		787-1638	222	788-178	244		
780-xxx	96	787-1640	222	788-180	244	793-3508	276
		787-1642	222	788-303	243	793-3544	276
		787-1644	222			793-3545	276
<b>781 Series</b>		787-1650	225	788-307	243	793-3565	276
781-xxx	96	787-1662	226	788-311	243	793-3566	276
		787-1662/000-054	226			793-3599	276
		787-1662/000-250	226	788-315	243	793-4472	276
		787-1662/004-1000	226	788-341	243	793-4501	38

# Item Number Index

Item No.	Page	Item No.	Page	Item No.	Page	Item No.	Page
<b>793 Series</b>		<b>830 Series</b>		<b>855 Series</b>		<b>859 Series</b>	
793-4501/000-002	38	830-xxx	267	855-5105/300-001	259	859-791	241
793-4501/000-005	38						
793-4501/000-006	38	<b>831 Series</b>		855-5105/1000-000	259	859-798	241
793-4501/000-007	38	831-137	142	855-8001	261	859-902	241
793-4501/000-012	38	831-3xx	142				
793-4501/000-017	38	831-5xx	141	855-8004	261	<b>862 Series</b>	
793-4501/000-023	38	831-1032	142	855-8006	261	862-503	106
793-4501/000-024	38	831-11xx	140	855-8008	261	862-504	106
793-4502	276	831-12xx	140	855-8015	261	862-505	106
		831-3xxx	140	855-9150/2000-701	260	862-515	107
793-4508	276			855-9150/2000-1251	260	862-525	107
793-4544	276	<b>832 Series</b>		855-9150/2000-1751	260	862-532	107
793-4545	276	832-522	142	855-9450/2000-701	260	862-533	107
793-4565	276	832-523	142	855-9450/2000-1251	260	862-534	107
793-4566	276	832-532	141	855-9450/2000-1751	260	862-552	106
793-4599	276			855-9900	258	862-562	107
793-4602	276	832-535	141	855-9910	258	862-593	107
		832-542	141	855-9927	260	862-594	107
793-4608	276			<b>857 Series</b>		862-603	106
793-4644	276	832-545	141	857-3xx	238	862-604	106
793-4645	276	832-1032	142	857-4xx	228	862-605	106
793-4666	276	832-11xx	140	857-500	235	862-615	107
793-4699	276	832-12xx	140	857-531	235	862-625	107
793-4900	276	832-3xxx	140	857-550	230	862-632	107
793-5472	276			857-551	230	862-633	107
793-5501	38	<b>852 Series</b>		857-552	230	862-634	107
793-5501/000-002	38	852-xxxx	214	857-552	230	862-652	106
793-5501/000-005	38			857-560	230	862-662	107
793-5501/000-006	38	<b>855 Series</b>		857-569	230	862-693	107
793-5501/000-007	38	855-301/050-103	258	857-604	238	862-694	107
793-5501/000-012	38			857-624	239	862-1503	106
793-5501/000-017	38	855-301/600-1001	258	857-634	239	862-1503/999-950	106
793-5501/000-023	38	855-305/050-103	258	857-640	238	862-1504	106
793-5501/000-024	38			857-642	238	862-1504/999-950	106
793-5502	276	855-305/750-509	258	857-7xx	239	862-1505	106
		855-401/250-501	258	857-800	232	862-1505/999-950	106
793-5508	276	855-401/400-501	258	857-801	232	862-1515	107
793-5544	276	855-401/600-501	258	857-808	232	862-1515/999-950	107
793-5545	276	855-405/200-209	258	857-809	235	862-1525	107
793-5565	276			857-810	232	862-1525/999-950	107
793-5566	276	855-405/750-509	258	857-811	232	862-1532	107
793-5599	276	855-501/150-000	261	857-812	232	862-1532/999-959	107
793-5602	276	855-501/400-1001	258	857-815	232	862-1533	107
				857-818	232	862-1533/999-950	107
793-5608	276	855-501/1000-1001	258	857-819	230	862-1534	107
793-5644	276	855-505/400-1001	258	857-820	232	862-1534/999-950	107
793-5645	276			857-979	234	862-1552	106
793-5666	276	855-505/1000-1001	258	857-980	235	862-1552/999-950	106
793-5699	276	855-601/1500-501	258	857-981	238	862-1562	107
793-5900	276	855-605/1500-501	258	857-982	238	862-1562/999-950	107
		855-801/1000-1001	258	857-986	238	862-1593	107
<b>794 Series</b>		855-801/2000-1001	258	857-1330	238	862-1593/999-950	107
794-xxx	276	855-805/2000-1001	258	857-1430	239	862-1594	107
		855-801/2500-1001	258	857-1432	239	862-1594/999-950	107
<b>804 Series</b>		855-801/2000-1001	258	857-1494	239	862-1603	106
804-1xx	147	855-805/2000-1001	258			862-1603/999-950	106
804-3xx	148	855-951/250-000	261	<b>858 Series</b>		862-1604	106
		855-1001/2500-1001	258	858-xxx	245	862-1604/999-950	106
<b>805 Series</b>		855-1005/2500-1001	258			862-1605	106
805-xxx	146	855-1700/032-000	260	<b>859 Series</b>		862-1605/999-950	106
		855-1851/350-000	261	859-3xx	240	862-1615	107
		855-2701/035-001	260	859-4xx	240	862-1615/999-950	107
		855-2701/064-001	260	859-525	240	862-1625	107
<b>806 Series</b>		855-3001/060-003	259	859-702	242	862-1625/999-950	107
806-xxx	151			859-706	242	862-1632	107
		855-3001/250-001	259	859-708	242	862-1632/999-959	107
		855-4001/100-001	259	859-712	242	862-1633	107
<b>807 Series</b>				859-720	242	862-1633/999-950	107
807-090/101-100	275	855-4001/250-000	259	859-730	241	862-1634	107
		855-4005/150-101	259	859-732	242	862-1634/999-950	107
		855-4005/200-101	259	859-734	241	862-1652	106
<b>810 Series</b>		855-4005/250-100	259	859-737	241	862-1652/999-950	106
810-9xx	209	855-4101/200-001	259			862-1662	107
				859-740	241	862-1662/999-950	107
		855-4101/500-000	259	859-744	241	862-1693	107
<b>811 Series</b>		855-4105/250-101	259	859-750	242	862-1693/999-950	107
811-xxx	87			859-752	242	862-1694	107
		855-4105/500-101	259	859-753	242	862-1694/999-950	107
		855-5001/250-001	259	859-755	242	862-2503	106
<b>812 Series</b>				859-756	242	862-2504	106
812-xxx	100	855-5001/1000-000	259	859-758	242	862-2505	106
		855-5005/300-001	259	859-759	242	862-2515	107
				859-761	241	862-2525	107
<b>816 Series</b>		855-5005/1000-000	259	859-762	241	862-2532	107
816-xxx	147	855-5101/250-001	259			862-2533	107
				859-772	242	862-2534	107
		855-5101/1000-000	259			862-2552	106

## Item Number Index

Item No.	Page	Item No.	Page	Item No.	Page	Item No.	Page
<b>862 Series</b>		<b>2000 Series</b>		<b>2001 Series</b>		<b>2002 Series</b>	
862-2562	107	2000-1201	20	2001-1201	21	2002-1549	269
862-2593	107					2002-1568	269
862-2594	107	2000-1207	20	2001-1208	21	2002-1594	269
862-2603	106	2000-1291	20	2001-1211/1000-410	54	2002-1601	43
862-2604	106	2000-1292	20	2001-1211/1000-411	54	2002-1602	43
862-2605	106	2000-1301	20	2001-1301	21	2002-1604	43
862-2615	107					2002-1611	46
862-2625	107	2000-1307	20	2001-1308	21	2002-1611/1000-541	46
862-2632	107	2000-1391	20	2001-1311/1000-410	54	2002-1611/1000-542	46
862-2633	107	2000-1392	20	2001-1311/1000-411	54	2002-1611/1000-836	46
862-2634	107	2000-1401	20	2001-1321/1000-413	54	2002-1611/1000-867	46
862-2652	106			2001-1321/1000-434	54	2002-1661	43
862-2662	107	2000-1407	20	2001-1401	21	2002-1671	43
862-2693	107	2000-1491	20			2002-1671/401-000	43
862-2694	107	2000-1492	20	2001-1408	21	2002-1672	43
862-8503	106	2000-2141	20	2001-1411/1000-410	54	2002-1672/401-000	43
862-8504	106	2000-2195	20	2001-1411/1000-411	54	2002-1674	43
862-8505	106	2000-2195	20	2001-1421/1000-413	54	2002-1674/401-000	43
862-8515	107	2000-2196	20	2001-1421/1000-434	54	2002-1681	45
862-8525	107	2000-2201	32	2001-1441	21	2002-1691	43
862-8533	107			<b>2002 Series</b>		2002-1692	43
862-8534	107	2000-2204	32	2002-115	37	2002-1701	44
862-8593	107	2000-2207	32	2002-121	277	2002-1702	44
862-8594	107	2000-2208	32	2002-131	277	2002-1704	44
862-8603	106	2000-2209	32	2002-160	277	2002-1707	44
862-8604	106	2000-2217	32	2002-161	277	2002-1711	46
862-8605	106	2000-2218	32	2002-171	37	2002-1711/1000-541	46
862-8615	107	2000-2227	32	2002-172	37	2002-1711/1000-542	46
862-8625	107	2000-2228	32	2002-400	37	2002-1711/1000-836	46
862-8633	107	2000-2231	32	2002-401	43	2002-1711/1000-867	46
862-8634	107			2002-402	37	2002-1761	44
862-8693	107	2000-2234	32			2002-1771	44
862-8694	107	2000-2237	32	2002-405	37	2002-1771/401-000	44
862-9503	106	2000-2238	32	2002-405/011-000	37	2002-1772	44
862-9504	106	2000-2239	32	2002-406/020-000	37	2002-1772/401-000	44
862-9505	106	2000-2247	32	2002-410	37	2002-1774	44
862-9515	107	2000-2248	32	2002-415	37	2002-1774/401-000	44
862-9525	107	2000-2257	32	2002-423	37	2002-1781	45
862-9533	107	2000-2258	32	2002-433	37	2002-1791	44
862-9534	107	2000-5310/101-000	62	2002-434	37	2002-1792	44
862-9593	107	2000-5310/102-000	62	2002-435	37	2002-1801	44
862-9594	107	2000-5310/1101-951	62	2002-440	37	2002-1802	44
862-9603	106	2000-5310/1102-950	62	2002-472	37	2002-1804	44
862-9604	106	2000-5311	60	2002-473	37	2002-1811	46
862-9605	106	2000-5311/1101-951	60	2002-482	37	2002-1811/1000-541	46
862-9615	107	2000-5311/1102-950	60	2002-492	37	2002-1811/1000-542	46
862-9625	107	2000-5317/101-000	62	2002-492/000-012	37	2002-1811/1000-836	46
862-9633	107	2000-5317/102-000	62	2002-493	37	2002-1811/1000-867	46
862-9634	107	2000-5317/1101-951	62	2002-511	37	2002-1861	44
862-9693	107	2000-5317/1102-950	62	2002-541	37	2002-1871	44
862-9694	107	2000-5352	60	2002-549	37	2002-1871/401-000	44
		2000-5352/1102-953	60	2002-800	269	2002-1872	44
		2000-5357/101-000	62	2002-810	269	2002-1872/401-000	44
<b>870 Series</b>		2000-5357/102-000	62	2002-820	269	2002-1874	44
870-xxx	94	2000-5372	60	2002-880	269	2002-1874/401-000	44
		2000-5372/1102-953	60	2002-1091	53	2002-1881	45
		2000-5377/101-000	62	2002-1092	53	2002-1891	44
<b>879 Series</b>		2000-5377/102-000	62	2002-1201	22	2002-1892	44
879-xxxx	252	2000-5391	60			2002-1901	43
		2000-5410	61	2002-1208	22	2002-1902	43
		2000-5410/1101-951	61	2002-1211/1000-410	55	2002-1904	43
<b>887 Series</b>		2000-5417	61	2002-1211/1000-411	55	2002-1907	43
887-xxx	123	2000-5417/1101-951	61	2002-1291	21	2002-1911	46
		2000-5417/1102-950	61			2002-1911/1000-541	46
		2000-5457	61	2002-1294	21	2002-1911/1000-542	46
<b>890 Series</b>		2000-5477/1102-953	61	2002-1301	22	2002-1911/1000-836	46
890-xxxx	159	2000-5477	61			2002-1911/1000-867	46
		2000-5477/1102-953	61	2002-1308	22	2002-1961	248
		2000-5491	61	2002-1311/1000-410	55	2002-1971	43
<b>2000 Series</b>		<b>2001 Series</b>		2002-1311/1000-411	55	2002-1971/401-000	43
2000-115	37	2001-115	37	2002-1321/1000-413	55	2002-1972	43
2000-121	277	2001-171	37	2002-1321/1000-434	55	2002-1972/401-000	43
2000-402	37	2001-402	37	2002-1391	21	2002-1974	43
						2002-1974/401-000	43
2000-405	37	2001-405	37	2002-1394	21	2002-1981	45
2000-405/011-000	37			2002-1401	22	2002-1981/1000-413	45
2000-406/020-000	37	2001-405/011-000	37			2002-1981/1000-414	45
2000-406/020-000	101	2001-406/020-000	37	2002-1408	22	2002-1981/1000-429	45
2000-410	37	2001-410	37	2002-1411/1000-410	55	2002-1981/1000-434	45
2000-433	37	2001-433	37	2002-1411/1000-411	55	2002-1981/1000-435	45
2000-434	37	2001-434	37	2002-1421/1000-413	55	2002-1981/1000-449	45
2000-435	37	2001-435	37	2002-1421/1000-434	55	2002-1991	43
2000-440	37	2001-440	37	2002-1441	23	2002-1992	43
2000-492	37	2001-511	37	2002-1491	21	2002-2201	32
2000-510	37	2001-549	37				
2000-549	37			2002-1494	21	2002-2204	32
						2002-2207	32

# Item Number Index

Item No.	Page	Item No.	Page	Item No.	Page	Item No.	Page
<b>2002 Series</b>		<b>2002 Series</b>		<b>2004 Series</b>		<b>2006 Series</b>	
2002-2208	32	2002-2959	52	2004-1301	24	2006-8601	47
2002-2209	32	2002-2971	52			2006-8604	47
2002-2211/1000-410	57	2002-2972	52	2004-1307	24	2006-8661	47
2002-2211/1000-411	57	2002-2974	52	2004-1311/1000-400	56	2006-8664	47
2002-2213/1000-487	57	2002-2991	52	2004-1311/1000-401	56	2006-8671	47
2002-2213/1000-488	57	2002-2992	52	2004-1391	24	2006-8674	47
2002-2214/1000-489	57	2002-3201	34				
		2002-3203	34	2004-1394	24	<b>2007 Series</b>	
2002-2214/1000-492	57	2002-3204	34	2004-1401	25	2007-8801	51
2002-2214/1000-980	57	2002-3207	34			2007-8804	51
2002-2217	32	2002-3208	34	2004-1408	25	2007-8807	51
2002-2218	32	2002-3209	34	2004-1411/1000-400	56	2007-8811	51
2002-2221/1000-413	57	2002-3211/1000-410	58	2004-1411/1000-401	56	2007-8821	51
2002-2221/1000-434	57	2002-3211/1000-411	58	2004-1491	25	2007-8842	51
2002-2227	32	2002-3211/1000-675	58			2007-8843	51
2002-2228	32	2002-3211/1000-676	58	2004-1494	25	2007-8848	51
2002-2231	32	2002-3212/1000-673	58			2007-8873	257
2002-2232	32	2002-3212/1000-674	58	<b>2005 Series</b>		2007-8874	175
2002-2233	32	2002-3217	34	2005-xxxx	41	2007-8875	257
2002-2234	32	2002-3218	34			2007-8877	175
2002-2237	32	2002-3221/1000-413	58	<b>2006 Series</b>		2007-8891	51
2002-2238	32	2002-3221/1000-434	58	2006-115	37		
2002-2239	32	2002-3227	34	2006-401	47	2007-8894	51
2002-2247	32	2002-3228	34	2006-402	37		
2002-2248	32	2002-3231	34			<b>2009 Series</b>	
2002-2257	32	2002-3233	34	2006-405	37	2009-110	273
2002-2258	32	2002-3234	34	2006-405/011-000	37	2009-113	273
2002-2291	32	2002-3237	34	2006-433	37	2009-113/000-002	273
2002-2292	32	2002-3238	34	2006-434	37	2009-113/000-005	273
2002-2401	33	2002-3239	34	2006-435	37	2009-113/000-006	273
		2002-3247	34	2006-499	37	2009-113/000-007	273
2002-2404	33	2002-3248	34	2006-511	37	2009-113/000-012	273
2002-2407	33	2002-3257	34	2006-549	37	2009-113/000-017	273
2002-2408	33	2002-3258	34	2006-1201	26	2009-113/000-023	273
2002-2409	33	2002-3291	34	2006-1202	26	2009-113/000-024	273
2002-2417	33	2002-3292	34	2006-1204	26	2009-114	273
2002-2418	33	2002-4101	34	2006-1207	26	2009-114/000-002	273
2002-2427	33	2002-4111	34	2006-1208	26	2009-114/000-005	273
2002-2428	33	2002-4127	34	2006-1209	26	2009-114/000-006	273
2002-2431	33	2002-4131	34	2006-1291	26	2009-114/000-007	273
		2002-4141	34			2009-114/000-012	273
2002-2434	33	2002-4157	34	2006-1294	26	2009-114/000-023	273
2002-2437	33	2002-4191	34	2006-1301	26	2009-114/000-024	273
2002-2438	33	2002-4192	34			2009-115	273
2002-2439	33	2002-6301	23	2006-1305	26	2009-115/000-002	273
2002-2447	33			2006-1307	26	2009-115/000-005	273
2002-2448	33	2002-6308	23	2006-1391	26	2009-115/000-006	273
2002-2457	33	2002-6391	23			2009-115/000-007	273
2002-2458	33	2002-6392	23	2006-1394	26	2009-115/000-012	273
2002-2491	33	2002-6401	23	2006-1601	47	2009-115/000-017	273
2002-2492	33			2006-1604	47	2009-115/000-023	273
2002-2601	32	2002-6407	23	2006-1611	48	2009-115/000-024	273
				2006-1611/1000-541	48	2009-141	273
2002-2604	32	<b>2003 Series</b>		2006-1611/1000-542	48	2009-145	273
2002-2607	33	2003-xxxx	41	2006-1611/1000-836	48	2009-145/000-002	273
2002-2608	33			2006-1611/1000-867	48	2009-145/000-005	273
2002-2611	53	<b>2004 Series</b>		2006-1621	48	2009-145/000-006	273
2002-2611/1000-541	53	2004-115	37	2006-1621/1000-541	48	2009-145/000-007	273
2002-2611/1000-542	53	2004-171	37	2006-1621/1000-542	48	2009-145/000-012	273
2002-2611/1000-836	53	2004-172	37	2006-1621/1000-836	48	2009-145/000-023	273
2002-2611/1000-867	53	2004-402	37	2006-1621/1000-859	48	2009-145/000-024	273
2002-2612	53			2006-1621/1000-867	48	2009-163	277
2002-2647	32	2004-405	37	2006-1631	48	2009-174	38
2002-2657	32	2004-405/011-000	37	2006-1631/099-000	48	2009-180	278
2002-2661	52	2004-405/011-000	37	2006-1631/1000-541	48	2009-182	38
2002-2662	52	2004-406/020-000	37	2006-1631/1000-542	48	2009-191	277
2002-2667	52	2004-410	37	2006-1631/1000-836	48	2009-192	277
2002-2671	52	2004-433	37	2006-1631/1000-859	48	2009-192	277
2002-2672	52	2004-434	37	2006-1631/1000-867	48	2009-193	277
2002-2678	52	2004-435	37	2006-1631/1099-541	48	2009-196	277
2002-2691	32	2004-440	37	2006-1631/1099-542	48	2009-198	277
2002-2692	32	2004-511	37	2006-1631/1099-836	48	2009-309	279
2002-2701	33	2004-541	37	2006-1631/1099-859	48	2009-310	279
		2004-549	37	2006-1631/1099-867	48	2009-412	38
2002-2704	33	2004-911	53	2006-1671	47	2009-414	38
2002-2707	33	2004-911/1000-541	53	2006-1671/1000-848	47	2009-414/000-005	38
2002-2707/999-950	33	2004-911/1000-542	53	2006-1671/1000-849	47	2009-414/000-006	38
2002-2708	33	2004-911/1000-836	53	2006-1671/1000-850	47	2009-416	38
2002-2709	33	2004-911/1000-867	53	2006-1671/1000-851	47	2009-515	273
2002-2717	33	2004-1201	24	2006-1674	47	2009-615	273
2002-2727	33			2006-1681	48		
2002-2791	33	2004-1207	24	2006-1681/1000-413	48	<b>2010 Series</b>	
2002-2792	33	2004-1211/1000-400	56	2006-1681/1000-414	48	2010-115	37
2002-2951	52	2004-1211/1000-401	56	2006-1681/1000-429	48	2010-402	37
2002-2952	52	2004-1291	24	2006-1681/1000-434	48	2010-403	37
2002-2954	52			2006-1681/1000-435	48	2010-404	37
2002-2958	52	2004-1294	24	2006-1681/1000-449	48	2010-405	37

# Item Number Index

Item No.	Page	Item No.	Page	Item No.	Page	Item No.	Page
<b>2010 Series</b>		<b>2020 Series</b>		<b>2022 Series</b>		<b>2042 Series</b>	
2010-405/011-000	37	2020-1201	65	2022-182	67	2042-3004	246
2010-433	37	2020-1204	65	2022-184	67	2042-3014	246
2010-434	37	2020-1207	65	2022-187	67	2042-3024	247
2010-435	37	2020-1291	65	2022-1201	68	2042-3034	246
2010-511	37	2020-1292	65	2022-1201/999-953	70	2042-3044	246
2010-549	37	2020-1301	65	2022-1202	68	2042-3054	246
2010-1201	27	2020-1304	65	2022-1204	68	2042-3064	246
2010-1202	27	2020-1307	65	2022-1204/999-953	70	2042-3074	247
2010-1204	27	2020-1391	65	2022-1207	68	2042-3084	247
2010-1205	27	2020-1392	65	2022-1207/999-953	70	2042-3809	246
2010-1207	27	2020-1401	65	2022-1291	68	2042-3819	246
2010-1208	27	2020-1404	65	2022-1292	68	2042-3829	247
2010-1291	27	2020-1407	65	2022-1301	68	2042-3839	246
2010-1292	27	2020-1491	65	2022-1301/999-953	70	2042-3849	246
2010-1301	27	2020-1492	65	2022-1302	68	2042-3859	246
2010-1302	27	2020-2201	65	2022-1304	68	2042-3869	246
2010-1304	27			2022-1304/999-953	70	2042-3879	247
2010-1305	27	2020-2204	65	2022-1307	68	2042-3889	247
2010-1307	27	2020-2207	65	2022-1307/999-953	70	2042-7204	248
2010-1391	27	2020-2208	65	2022-1391	68	2042-7304	248
2010-1392	27	2020-2209	65	2022-1392	68	2042-7504	248
		2020-2217	65	2022-1401	68	2042-7604	248
		2020-2227	65	2022-1401/999-953	70		
		2020-2231	65	2022-1402	68	<b>2050 Series</b>	
				2022-1404	68	2050-xxxx	102
<b>2016 Series</b>		2020-2234	65	2022-1404/999-953	70		
2016-115	37	2020-2237	65	2022-1407	68	<b>2059 Series</b>	
2016-402	37	2020-2238	65	2022-1407/999-953	70	2059-xxx	152
2016-403	37	2020-2239	65	2022-1491	68		
2016-404	37	2020-2247	65	2022-1492	68	<b>2060 Series</b>	
2016-405	37	2020-2257	65	2022-1601	68	2060-189	152
2016-405/011-000	37	2020-2291	65	2022-1602	68	2060-451/998-404	152
2016-433	37	2020-2292	65	2022-1604	68	2060-453/998-404	152
2016-434	37	2020-5311	63	2022-1607	68	2060-471/998-404	152
2016-435	37	2020-5311/1102-950	63	2022-1691	68	2060-473/998-404	152
2016-499	37	2020-5317/102-000	63	2022-1692	68	2060-852/998-404	153
2016-511	37	2020-5317/1102-950	63	2022-1801	68	2060-951/028-000	152
2016-549	37	2020-5372	63	2022-1802	68	2060-954/028-000	152
2016-1201	28	2020-5372/1102-953	63	2022-1804	68	2060-962/028-000	153
		2020-5377/102-000	63	2022-1807	68	2060-1451/998-404	152
2016-1204	28	2020-5391	63	2022-1891	68	2060-1453/998-404	152
2016-1207	28	2020-5417	63	2022-1892	68	2060-1471/998-404	152
2016-1208	28	2020-5417/1102-950	63	2022-2201	68	2060-1473/998-404	152
2016-1291	28	2020-5477	63	2022-2201/999-953	70	2060-1473/998-404	152
2016-1292	28	2020-5477/1102-953	63	2022-2202	68	2060-1852/998-404	153
2016-1301	28	2020-5491	63	2022-2202/999-953	70	2060-1872/998-404	153
				2022-2203	68		
2016-1307	28	<b>2022 Series</b>		2022-2203/999-953	70	<b>2061 Series</b>	
2016-1391	28	2022-100	69	2022-2204	68	2061-xxxx	152
2016-1392	28	2022-101	69	2022-2204/999-953	70		
2016-7111	41	2022-102	69	2022-2207/999-953	70	<b>2065 Series</b>	
2016-7114	41	2022-102/000-037	69	2022-2208	69	2065-xxx	153
2016-7192	41	2022-102/999-953	71	2022-2208/999-953	70		
2016-7601	41	2022-103/000-036	69	2022-2209	69	<b>2070 Series</b>	
2016-7604	41	2022-103/000-037	69	2022-2209/999-953	70	2070-xxx	153
2016-7607	41	2022-103/000-038/999-953	71	2022-2217	68		
2016-7691	41	2022-103/000-039/999-953	71	2022-2217/999-953	70	<b>2075 Series</b>	
2016-7692	41	2022-103/999-953	71	2022-2227	68	2075-381/997-404	152
2016-7711	41	2022-104/000-036	69	2022-2227	68		
2016-7714	41	2022-104/000-038/999-953	71	2022-2227/999-953	70	<b>2091 Series</b>	
2016-7792	41	2022-104/000-039/999-953	71	2022-2217/999-953	70	2091-1102	127
		2022-104/999-953	71	2022-2231	68	2091-1102/002-000	127
<b>2020 Series</b>		2022-104/999-953	71	2022-2231/999-953	70	2091-1112	127
2020-100	65	2022-105/000-038/999-953	71	2022-2232	68	2091-1112/002-000	127
2020-102	66	2022-105/000-038/999-953	71	2022-2232/999-953	70	2091-1112	127
2020-103/000-036	66	2022-105/999-953	71	2022-2233	68	2091-1112/002-000	127
2020-103/000-037	66	2022-106/000-038/999-953	71	2022-2233/999-953	70	2091-1122	127
2020-115	66	2022-106/000-039/999-953	71	2022-2234	68	2091-1132	127
2020-115/000-036	66	2022-106/999-953	71	2022-2234/999-953	70	2091-1152	129
2020-115/000-037	66	2022-107/999-953	71	2022-2237	69	2091-1162	129
2020-161	66	2022-108/999-953	71	2022-2237/999-953	70	2091-1172	129
2020-164	66	2022-115	69	2022-2237/999-953	70	2091-1182	129
2020-167	66	2022-115/000-036	69	2022-2238	69	2091-1302	127
2020-181	66	2022-115/000-037	69	2022-2238/999-953	70	2091-1308	127
2020-184	66	2022-141	66	2022-2239	69	2091-1322	127
2020-187	66	2022-142	66	2022-2239/999-953	70	2091-1328	127
2020-202	66	2022-151	66	2022-2247	68	2091-1352	129
2020-203/000-036	66	2022-152	66	2022-2247/999-953	70	2091-1362	129
2020-203/000-037	66	2022-161	67	2022-2257	68	2091-1372	129
2020-215	66	2022-162	67	2022-2257/999-953	70	2091-1382	129
2020-215/000-036	66	2022-164	67	2022-2291	68	2091-1402	127
2020-215/000-037	66	2022-167	67	2022-2292	68	2091-1412	127
2020-261	66	2022-171	67				
2020-264	66	2022-172	67	<b>2042 Series</b>			
2020-267	66	2022-174	67	2042-321	269		
2020-281	66	2022-177	67	2042-331	269		
2020-284	66	2022-181	67	2042-341	269		
2020-287	66			2042-351	269		

# Item Number Index

Item No.	Page	Item No.	Page	Item No.	Page	Item No.	Page
<b>2091 Series</b>		<b>2202 Series</b>		<b>2210 Series</b>		<b>2759 Series</b>	
2091-1422	127	2202-1604	43	2210-xxxx	27	2759-101/1110-2002	168
2091-1432	127	2202-1611	46				
2091-1522/002-000	127	2202-1611/1000-541	46			2759-101/1110-4000	168
2091-1528/002-000	127	2202-1611/1000-542	46	<b>2216 Series</b>		2759-204/261-1000	175
2091-1600	129	2202-1611/1000-836	46	2216-xxxx	28	2759-206/261-1000	177
2091-1600/002-000	129	2202-1611/1000-867	46			2759-207/271-1000	177
2091-1603	129	2202-1661	43	<b>2231 Series</b>		2759-1061/651-010	166
2091-1610	126	2202-1671	43	2231-1xx	135	2759-1061/651-050	166
2091-1632/024-000	127	2202-1672	43	2231-2xx	138	2759-1061/651-100	166
2091-1638/024-000	127	2202-1674	43	2231-3xx	136	2759-2101/271-1000	175
		2202-1681	45	2231-7xx	139	2759-2102/271-1000	175
		2202-1701	44			2759-2103/271-1000	175
<b>2092 Series</b>		2202-1702	44	<b>2250 Series</b>		<b>2773 Series</b>	
2092-1152	129	2202-1704	44	2250-xxx	102	2773-xxxx	119
2092-1162	129	2202-1707	44				
2092-1172	129	2202-1711	46	<b>2273 Series</b>		<b>2787 Series</b>	
2092-1182	129	2202-1711/1000-541	46	2273-202	117	2787-xxxx	220
2092-1352	129	2202-1711/1000-542	46	2273-202/996-030	124		
2092-1362	129	2202-1711/1000-836	46	2273-202/996-040	124	<b>2789 Series</b>	
2092-1372	129	2202-1711/1000-867	46	2273-203	117	2789-xxxx	220
2092-1382	129	2202-1772	44	2273-204	117		
2092-1600	129	2202-1774	44	2273-204/996-020	124	<b>2851 Series</b>	
2092-1600/002-000	129	2202-1781	45	2273-205	117	2851-xxxx	175
2092-1603	129	2202-1801	44	2273-205/996-020	124		
2092-1630	129	2202-1802	44	2273-208	117	<b>2852 Series</b>	
2092-3152	129	2202-1804	44	2273-208/996-010	124	2852-xxxx	175
2092-3155	129	2202-1811	46	2273-500	117		
2092-3172	129	2202-1811/1000-541	46	<b>2604 Series</b>		<b>2857 Series</b>	
2092-3175	129	2202-1811/1000-542	46	2604-11xx	147	2857-401	228
2092-3352	129	2202-1811/1000-836	46	2604-13xx	148	2857-533	235
2092-3355	129	2202-1811/1000-867	46	2604-15xx	150	2857-534	235
2092-3372	129	2202-1861	44	<b>2606 Series</b>		2857-535	232
2092-3375	129	2202-1871	44	2606-11xx	148	2857-535/000-001	232
2092-3600	129	2202-1872	44	2606-13xx	150	2857-550	230
2092-3600/002-000	129	2202-1874	44	2606-3xxx	150	2857-569	230
2092-3603	129	2202-1881	45			2857-570/024-000	230
2092-3603/002-000	129	2202-1901	43	<b>2616 Series</b>		2857-570/024-001	230
		2202-1902	43	2616-11xx	149	2857-570/024-005	230
		2202-1904	43	2616-13xx	150	2857-900	235
		2202-1907	43	2616-3xxx	150		
		2202-1911	46	<b>2624 Series</b>		<b>8003 Series</b>	
<b>2102 Series</b>		2202-1911/1000-541	46	2624-11xx	147	8003-099/750-8100	186
2102-xxxx	22	2202-1911/1000-542	46	2624-13xx	148	8003-099/762-5303	179
		2202-1911/1000-836	46	2624-15xx	150		
		2202-1911/1000-867	46	<b>2626 Series</b>			
<b>2104 Series</b>		2202-1961	248	2626-11xx	148		
2104-xxxx	24	2202-1971	43	2626-1352	150		
		2202-1972	43	<b>2636 Series</b>			
<b>2106 Series</b>		2202-1974	43	2636-11xx	149		
2106-xxxx	26	2202-1981	45	2636-13xx	150		
		2202-1981/1000-413	45	2636-3xxx	150		
		2202-1981/1000-414	45	<b>2687 Series</b>			
<b>2110 Series</b>		2202-1981/1000-414	45	2687-xxxx	223		
2110-xxxx	27	2202-1981/1000-429	45				
		2202-1981/1000-434	45	<b>2706 Series</b>			
		2202-1981/1000-435	45	2706-1xx	148		
<b>2116 Series</b>		2202-1981/1000-449	45	2706-2xx	149		
2116-xxxx	28	2202-2701	33	2706-3xx	150		
		2202-2704	33	<b>2716 Series</b>			
<b>2200 Series</b>		2202-2707	33	2716-1xx	149		
2200-xxxx	20	2202-2708	33	2716-2xx	150		
		2202-2709	33				
		2202-2717	33	<b>2721 Series</b>			
<b>2201 Series</b>		2202-2727	33	2721-1xx	134		
2201-xxxx	21	2202-6301	23	2721-2xx	137		
				<b>2734 Series</b>			
		2202-6308	23	2734-1xx	132		
<b>2202 Series</b>		2202-6401	23	2734-2xx	133		
2202-1201	22						
2202-1203	22	2202-6407	23				
2202-1204	22						
2202-1205	22	<b>2204 Series</b>					
2202-1207	22	2204-1201	24				
2202-1209	22	2204-1204	24	<b>2716 Series</b>			
2202-1301	22	2204-1207	24	2716-1xx	149		
		2204-1301	24	2716-2xx	150		
2202-1307	22	2204-1304	24				
2202-1401	22	2204-1307	24	<b>2721 Series</b>			
2202-1401/000-001	22	2204-1401	25	2721-1xx	134		
2202-1404	22	2204-1404	25	2721-2xx	137		
2202-1407	22	2204-1407	25	<b>2734 Series</b>			
2202-1409	22			2734-1xx	132		
2202-1441	23	<b>2206 Series</b>		2734-2xx	133		
2202-1601	43	2206-xxxx	26				
2202-1602	43						

# Item Number Index

Item No.	Page	Item No.	Page	Item No.	Page	Item No.	Page

# WAGO Worldwide

## Companies and Representatives

- Algeria**  
please contact WAGO France
- Argentina**  
Bruno Schillig S.A.  
Arenales 4030, B1604CFD  
Florida, PBA  
Phone +54 11 4730 1100  
Fax +54 11 4761 7244  
wago@schillig.com.ar
- Armenia**  
ROOT ITSP LLC  
33 Halabyan str.  
0038, Yerevan  
info@root.am
- Australia**  
WAGO Pty. Ltd.  
2-4 Overseas Drive  
Noble Park Victoria 3174  
Phone +61 03 8791 6300  
Fax +61 03 9701 0177  
sales.anz@wago.com
- Austria**  
WAGO Kontakttechnik Ges.m.b.H.  
Europaring F15 602  
Campus 21  
2345 Brunn am Gebirge  
Phone +43 1 6150780  
Fax +43 1 6150775  
wago-at@wago.com
- Azerbaijan**  
AZ Technics LTD  
Zulfi V. Alizade  
Y.Safarov str.33, AZ1025,  
Baku  
Phone +994 50 210 24 49  
Fax +994 12 496 83 34  
info@AZtechnics.az
- Bangladesh**  
please contact WAGO India
- Belarus**  
DemsEnergo LLC  
Vostochnaya Str. 39, Office 1N.  
220040 Minsk  
Phone +375 17 2102189  
Fax +375 17 2102189  
dems@dems.by
- ATAVA Techno Ltd.  
Ul. Denisovskaya 47, office 1  
220006 Minsk  
Phone +375173881018  
atava@atava.by
- Belgium**  
WAGO BeLux nv  
Excelsiorlaan 11  
1930 Zaventem  
Phone +32 2 717 9090  
Fax +32 2 717 9099  
info-be@wago.com
- Bolivia**  
ISOTEK S.R.L.  
Zona Casco Viejo  
Calle Isso #578, B/San Roque  
Santa Cruz  
Phone +591 721 000 27  
info@isotek.bo
- Bosnia & Herzegovina**  
please contact WAGO Bulgaria
- Brazil**  
WAGO Eletroeletrônicos Ltda  
Rua Tripoli, 640, Loteamento Multivias II  
Jardim Ermida I  
Jundiaí - SP  
CEP 13212-217  
Phone +55 (11) 2923 7200  
info.br@wago.com
- Bulgaria**  
WAGO Kontakttechnik GmbH & Co. KG  
Representative Office Sofia  
Business Center Serdiika  
2E Akad. Ivan Geshov Blvd.  
Building 1, Floor 4, Office 417  
1330 Sofia  
Phone +359 2 489 46 09/10  
Fax +359 2 928 28 50  
info-BG@wago.com
- Canada**  
WAGO Canada, Inc.  
1550 Yorkton Court - Unit 1  
Burlington, ON L7P 5B7  
Phone +1-888-9246-221  
info.ca@wago.com
- Chile**  
Desimat Chile  
Av Puerto Vespuccio 9670  
Pudahuel Santiago  
Phone +56 2 747 0152  
Fax +56 2 747 0153  
ventaschile@desimat.cl
- China**  
WAGO Electronic (Tianjin) Co., Ltd.  
No.5, Quan Hui Road  
Wuqing Development Area  
Tianjin 301700  
Phone +86 22 5967 7688  
Fax +86 22 5961 7668  
info-cn@wago.com
- Colombia**  
T.H.L. Ltda.  
Cra. 49 B #91-33  
Bogotá  
Phone +57 1 621 85 50  
Fax +57 1 621 60 28  
ventas-thl2@thl.com.co
- Croatia**  
M.B.A. d.o.o.  
Frana Supila 5  
51211 Matulji  
Phone +385 51 275-736  
Fax +385 51 275-066  
mba@ri.htnet.hr
- MICROSTAR d.o.o.  
Siget 18 b  
10020 Zagreb  
Phone +385 1 3647 849  
Fax +385 1 3636 662  
wago@microstar.hr
- Czech Republic**  
WAGO Elektro spol. sr. o.  
Rozvodova 1116/36  
143 00 Praha 12 - Modřany  
Phone +420 261 090 143  
info.cz@wago.com  
wago-cz@wago.com
- Denmark**  
WAGO Denmark A/S  
Lejrvej 17  
3500 Værløse  
Phone +45 44 357 777  
info.dk@wago.com
- Ecuador**  
ECUAINSETEC CIA LTDA  
Yugoslavia N34-110 y Azuay  
Quito  
Phone +593 2 24 50 475  
Fax +593 2 22 51 242  
g.castro@ecuainsetec.com.ec
- Egypt**  
IBN Engineering / Distributor (Automation  
Products)  
Phone +2 02 3 721 43 50  
Fax +2 02 3 722 17 09  
nasrelwy@ibnengineering.com
- Estonia**  
Eltarko OÜ  
Treiali tee 2 door 6  
Peetri küla  
Rae vald  
75312 Harjumaa  
Phone +372 651 7731/32  
Fax +372 651 7786  
andres@eltarko.ee
- Finland**  
WAGO Finland Oy  
Äyritie 12 B  
01510 Vantaa  
Phone +358 9 7744 060  
Fax +358 9 7744 0660  
info.fi@wago.com
- France**  
WAGO Contact SAS  
Paris Nord 2  
83 Rue des Chardonnerets  
93290 - Tremblay en France  
B.P. 95947 - ROISSY CDG CEDEX  
Phone +33 1 4817 2590  
Fax +33 1 4863 2520  
info-fr@wago.com
- Germany**  
WAGO Kontakttechnik GmbH & Co. KG  
Hansastraße 27  
32423 Minden  
Phone +49 571 887-0  
Fax +49 571 887-169  
info@wago.com
- WAGO Kontakttechnik GmbH & Co. KG  
Waldstraße 1  
99706 Sondershausen  
Phone +49 3632 659-0  
Fax +49 3632 659-100  
info@wago.com
- Great Britain**  
WAGO Limited  
Triton Park, Swift Valley Industrial Estate  
RUGBY  
Warwickshire, CV21 1SG  
Phone +44 1788 568 008  
Fax +44 1788 568 050  
uksales@wago.com
- Greece**  
PANAGIOTIS SP. DIMOULAS  
DIMOULAS AUTOMATIONS  
Kritis Str. 26  
10439 Athens  
Phone +30 210 883 3337  
Fax +30 210 883 4436  
wago.info@dimoulas.com.gr
- Honduras**  
CILASAS S.A. de C.V.  
Barrio Los Andes  
7 Calle entre 14 y 15 Ave. N.O.  
P.O. Box. 1061  
San Pedro Sula  
Phone +504 2557 1146/7  
Fax +504 2557 1149  
ventas@iecilasa.com
- Hong Kong**  
National Concord Eng., Ltd.  
Unit A-B, 5/F.  
Southeast Industrial Building  
611-619 Castle Peak Road  
Tsuen Wan, N.T.  
Phone +852 2429 2611  
Fax +852 2429 2164  
sales@nce.com.hk
- Hungary**  
WAGO Hungária KFT  
Ipari Park, Gyár u. 2  
2040 Budapest  
Phone +36 23 502-170  
Fax +36 23 502-1  
info.hu@wago.com
- Iceland**  
Johan Rönning ehf / S.Gudjonsson  
Smidjuvegur 3  
200 Kopavogur  
Phone +354 520-4500  
Fax +354 520-4501  
export@wago.com
- India**  
WAGO Private Limited  
C-27, Sector-58, Phase-III  
Noida-201 301  
Uttar Pradesh-201301  
Phone +91 120 438 8700  
Fax +91 120 438 8799  
info.india@wago.com
- Indonesia**  
please contact WAGO Singapore
- Irak**  
please contact WAGO Middle East
- Ireland**  
Drives & Controls  
Unit F4, Riverview Business Park  
Nangor Road  
Dublin 12  
Phone +353 1 4604474  
Fax +353 1 4604507  
info@drivesandcontrols.ie
- Israel**  
Comtel Israel Electronic Solutions Ltd.  
Bet Hapaamon  
20 Hataas Street  
P.O. Box 66  
44425 Kefar-Saba  
Phone +972 9 76 77 240  
Fax +972 9 76 77 243  
sales@comtel.co.il
- Italy**  
WAGO Elettronica SRL a Socio Unico  
Via Parini 1  
40033 Casalecchio di Reno (BO)  
Phone +39 051 6132112  
Fax +39 051 6132888  
info-ita@wago.com
- Japan**  
WAGO Co. of JAPAN Ltd.  
Kinshicho Prime Tower  
1-5-7, Kameido, Koto-ku  
Tokyo 136-0071  
Phone +81 3 5627 2050  
Fax +81 3 5627 2055  
info-jp@wago.com
- Jordanien**  
Oxgen for Engineering Systems Co. L.L.C  
PO Box: 2154 Amman  
11953 Jordan  
Phone +962 79 9 860 869  
Fax. +962 655 211 89  
info@oxgn-grp.com
- Kazakhstan**  
Axima LLP  
232/2, Ryskulov avenue  
050061 Almaty  
Phone +7 727 356 52 91/92/93  
Fax +7 727 327 14 92/93  
trade1@axima.kz  
or@axima.kz
- Technik-Tade LLC  
Kabanbay Batyra Str. 11  
office 305  
070004 Ust-Kamenogorsk  
Phone +7 7232 254064  
Fax +7 7232 253251  
info@technik.kz
- Korea**  
WAGO Korea Co., Ltd.  
Room A413~A416, A dong,  
Indukwon IT Valley Building, Imiro 40,  
Poil-dong,Uiwang-Si, Gyeonggi-do,  
16006, South Korea  
Phone +82 31 421 9500  
Fax +82 31 360 2476  
info.korea@wago.com
- Kosovo**  
please contact WAGO Bulgaria
- Latvia**  
INSTABALT LATVIA SIA  
Vestienas iela 6  
Riga, LV-1035  
Phone +371 6790 1188  
Fax +371 6790 1180  
info@instabalt.lv
- Lebanon**  
Gemayel Trading & Contracting  
Rue 55, Antonins Project-Bloc L  
P.O. BOX 70-1096  
Antelias, Lebanon  
Phone +961 3 22 30 29  
Fax +961 4 52 10 29  
info@gtclb.com
- Lithuania**  
INSTABALT LIT UAB  
Savanorių 187  
Vilnius, 2053  
Phone +370 52 322 295  
Fax +370 52 322 247  
info@instabalt.lt
- Luxembourg**  
please contact WAGO Belgium
- Malaysia**  
WAGO Automation Sdn. Bhd.  
No 806, Block A4, Leisure Commerce  
Square,  
No 9, Jalan PJS 8/9, 46150 Petaling Jaya,  
Selangor Darul Ehsan, Malaysia  
Phone +60 3 7877 1776  
Fax +60 3 7877 2776  
info-my@wago.com



**Maledivea**

please contact WAGO India

**Mexico**

WAGO S.A. de C.V.  
Carretera estatal 431 Km. 2+200  
Lote 99 Módulo 6  
Parque Industrial Tecnológico Innovación Querétaro  
El Marqués, Qro. 76246  
Phone +52 442 221 5946  
Fax +52 442 221 5063  
info.mx@wago.com

**Morocco**

Automatisme & Connection Maroc  
23, Rue Boured  
2ème étage, appt4  
Roche Noire  
20300 Casablanca  
Phone +212 522 24 21 72/73  
Fax +212 522 24 21 75  
info-fr@wago.com

**Nepal**

please contact WAGO India

**Netherlands**

WAGO Nederland B.V.  
Laan van de Ram 19  
7234 BW APELDOORN  
Phone +31 55 36 83 500  
Fax +31 55 36 83 599  
info-nl@wago.com

**New Zealand**

please contact WAGO Australia

Engineering Computer Services Ltd  
7-19 Ruffell Rd  
Hamilton, 3200  
New Zealand  
Phone +64 (0) 7 849 2211  
Fax +64 (0) 7 849 2220  
sales@ecsnz.com

**Nigeria**

GIL Automations Ltd.  
Daily Times Complex  
2 Lateef Jakande Rd., Agidingbi  
100271 Ikeja, Lagos State  
Phone +234 17132672335  
sales@gilautomation.com

**Norway**

WAGO Norge AS  
Jerikoveien 20  
1067 Oslo  
Phone +47 22 30 94 50  
Fax +47 22 30 94 51  
info.no@wago.com

**Oman**

please contact WAGO Middle East

**Pakistan**

FuziLogix Automation & Control  
Suit No. 14, 5th Floor, Shan Arcade  
New Garden Town, Lahore  
Phone +92 42 594 1503 - 4  
Fax +92 42 585 1431  
info@fuzilogix.com

**S.A. Hamid & Co.**

7 Brandreth Road  
Lahore, 54000  
Phone +92 42 376 500 99  
Fax +92 42 376 513 91  
sales@sahamid.com

**Paraguay**

AESA  
Av. Madame Lynch  
c/Antolin Irala  
2309 Asunción  
Phone +59 521674524  
info@aesa.com.py

**Philippines**

please contact WAGO Singapore

**Poland**

WAGO ELWAG sp. z o. o.  
ul. Piękna 58 a  
50-506 Wrocław  
Phone +48 71 3602970  
Fax +48 71 3602999  
wago.elwag@wago.com

**Portugal**

MORGADO & CA. LDA - SEDE  
Estrada Exterior da  
Circunvalação 3558/3560  
Apartado 1057  
4435 Rio Tinto  
Phone +351 22 9770600  
Fax +351 22 9770699  
geral@morgadocl.pt

**Quatar**

GEBD - Gulf European Business  
Development - Company W.L.L.)  
PO Box: 20 000  
Doha, Quatar  
Phone +974 5591 5682  
info@gebdc.com

**Republic of Moldova**

Smart Delight SRL  
Bulgara Str. 9/6  
2001 Chisinau  
Phone +373 (373) 69 10 22 01  
alexandres@starnet.md

**Republic of North Macedonia**

please contact WAGO Bulgaria

Kompjunet Inzenering  
Vladimir Komarov 1A-3/9  
1000 Skopje  
Phone +389 2 521 12 00

**Romania**

WAGO Kontakttechnik GmbH & Co. KG  
Representative Office Romania  
Sos. Pipera-Tunari nr. 1/1  
building 1, 2nd floor  
077190 Voluntari, Ilfov  
Phone +40-(0)31 421 85 68  
info-RO@wago.com

**Russia**

OOO WAGO Contact Rus  
Ilinskaya strret 5, bldg. 2  
127576 Moscow  
Phone +7 495 223-4747  
info.ru@wago.com  
www.wago.ru

**Saudi Arabia**

Saudi Electronic Trading  
P.O. Box 60712  
Riyadh 11555  
Phone +966 11 2063 377  
Fax +966 11 4633 297  
info@setra.com.sa

**Serbia**

please contact WAGO Bulgaria

Mehatronik Sistem d.o.o.  
Bul. Oslobodjenja 30  
32000 Cacak  
Phone +381 (0)32 310 088  
Fax. +381 (0)32 371 571  
Mobil +381 (0)64 877 22 02  
office@mehatronik.com

**Sigma Controls Engineering d.o.o.**

Jovana Skerlica 22  
18000 Nis  
Mobil +381 (0)63 403 104  
zeljko.savic@sce.rs

**Singapore**

WAGO Electronic Pte Ltd  
138 Joo Seng Road #06-01  
Singapore 368361  
Phone +65 62866776  
Fax +65 62842425  
info-sing@wago.com

**Slovakia**

Proelektro spol. s r.o.  
Na barine 22  
841 03 Bratislava - Lamač  
Phone +421 2 4569 2503  
info@wago.sk

**Slovenia**

IC elektronika d.o.o.  
Vodovodna cesta 100  
1000 Ljubljana  
Phone +386 1568 01 26  
Fax +386 1568 91 07  
info@ic-elect.si

**Slovenia**

Elektronabava d.o.o.  
Cesta 24 junija 3  
1231 Ljubljana  
Phone +386 1 58 99 300  
Fax +386 1 58 99 409  
info@elektronabava.si

**South Africa**

Shorrock Automation CC  
Nelmapius drive  
5 Regency Drive, Route 21 Corp. Park  
0051 Centurion  
Phone +27 12 4500300  
Fax +27 12 4500322  
sales@shorrock.co.za

**Spain**

DICOMAT S.L.  
Avda. de la Industria, 36  
Apartado Correos, 1.178  
28108-Alcobendas (Madrid)  
Phone +34 91 662 1362  
Fax +34 91 661 0089  
info@dicomat-asetyc.com

**Sri Lanka**

please contact WAGO India

**Sweden**

WAGO Sverige AB  
Box 11127, 161 11 BROMMA  
Besöksadress: Adolfsbergsv. 31  
Phone +46 858410680  
info.se@wago.com

**Switzerland**

WAGO CONTACT SA  
Rte. de l'Industrie 19  
Case Postale 168  
1564 Domdidier  
Phone +41/26 676 75 00  
Fax +41/26 676 75 01  
info.switzerland@wago.com

**Syria**

please contact WAGO Middle East

**Taiwan R.O.C.**

WAGO Contact, Ltd.  
5F, No.168, Jiankang Rd  
Zhonghe City  
Taipei County 23585, Taiwan  
Phone +886 2 2225 0123  
Fax +886 2 2225 1511  
info.taiwan@wago.com

**Thailand**

WAGO Contact Ltd.  
4th Floor, KS Building  
213/6-8 Rachada-Phisek Road  
Dingdaeng Bangkok 10400  
Phone +66 2 6935611  
Fax +66 2 6935612  
info-th@wago.com

**Tunisia**

please contact WAGO France

**Turkey**

WAGO Elektronik Sanayi ve Ticaret Ltd. Şti.  
Yukarı Dudullu Mahallesi Bayraktar Bulvarı  
Cad. Hattat Sok. No. 10  
34775 Ümraniye - İstanbul  
Phone +90 216 472 1133  
Fax +90 216 472 9910  
info.tr@wago.com

**Ukraine**

LLC RPE „Logicon“  
Predslavinskaya street, 37, office 303  
03150 Kiev  
Phone +380 44 5228019  
Fax +380 44 2611803  
info@logicon.ua

**Micropribor Ltd.**

4, Krzhizhanovsky Str.  
03142 Kiev  
Phone +380 44 392 93 86  
Fax +380 44 392 93 87  
sales@micropribor.kiev.ua

**United Arab Emirates (UAE)**

WAGO Middle East (FZC)  
SAIF Zone, Q4-282  
P.O. Box 120665  
Sharjah, UAE  
Phone +971 6 5579920  
Fax +971 6 5579921  
info.uae@wago.com

**Uruguay**

Fivisa Electricidad  
Avda. Uruguay 1274  
11100 Montevideo  
Phone +59 829 020 808  
Fax +59 829 021 230  
info@fivisa.com.uy

**USA**

WAGO CORPORATION  
N120 W19129 Freistadt Road  
Germantown, WI 53022  
Phone +1 262 255 6222  
Fax +1 262 255 3232  
Toll-Free: 1-800 DIN Rail (346-7245)  
info.us@wago.com

**Venezuela**

PETROBORNAS, C.A.  
C.C. PLAZA AEROPUERTO - PISO 1 - LO-  
CAL P1-B-03  
(8015) UNARE - PUERTO ORDAZ -  
ESTADO BOLÍVAR  
REPÚBLICA BOLIVARIANA DE  
VENEZUELA  
Phone +58 286 951 3382  
Fax +58 286 951 3382  
info@petrobornas.com

**Vietnam**

please contact WAGO Germany (Minden)

Version: 10/2020

Current addresses at www.wago.com





**WAGO Kontakttechnik GmbH & Co. KG**

Postfach 2880 · D · 32385 Minden  
Hansastraße 27 · D · 32423 Minden  
info@wago.com  
www.wago.com

Headquarters	+49 571 887 - 0
Sales	+49 571 887 - 44222
Order Service	+49 571 887 - 44333
Fax	+49 571 887 - 844169

WAGO is a registered trademark of WAGO Verwaltungsgesellschaft mbH.

“Copyright – WAGO Kontakttechnik GmbH & Co. KG – All rights reserved. The content and structure of the WAGO websites, catalogs, videos and other WAGO media are subject to copyright. Distribution or modification to the contents of these pages and videos is prohibited. Furthermore, the content may neither be copied nor made available to third parties for commercial purposes. Also subject to copyright are the images and videos that were made available to WAGO Kontakttechnik GmbH & Co. KG by third parties.”